

# Visual TikZ

**Version 0.66**

Jean Pierre Casteleyn  
IUT Génie Thermique et Énergie  
Dunkerque, France

mis à jour le 31 mai 2018

**Objectifs :**

- Avoir une image par commande ou par paramètre.
- Avoir un texte réduit au strict minimum.
- Etre le plus complet possible au fil de mises à jour régulières.
- Garder la même structure que visuel pstricks

**Remarques :** Le code donné est minimal et ne sert qu'à montrer les commandes concernées. Les effets sont parfois exagérés pour bien les mettre en évidence. Pour en savoir plus, vous pouvez voir la documentation. Pour se faire j'ai indiqué le numéro de Section de pgfmanual

**Vous pouvez me contacter** à mon e-mail personnel pour

- me signaler les erreurs que vous avez constatés (merci d'indiquer la page où vous l'avez constaté)
- me faire part de vos commentaires, suggestions ...

**Quoi de neuf! :**

- Ajout de la library chains 67
- Ajout de la library through 60
- Ajout de la library turtle 184
- Ajout de la library positioning 56
- Ajout du module tikzsymbols 155
- mise à jour du module tikzducks 149
- mise à jour des modules shape 91

**Licence :**

This work may be distributed and/or modified under the conditions of the LaTeX Project Public License, either version 1.3 of this license or (at your option) any later version.

The latest version of this license is in <http://www.latex-project.org/lppl.txt> and version 1.3 or later is part of all distributions of LaTeX version 2005/12/01 or later.

This work has the LPPL maintenance status 'maintained'.

The Current Maintainer of this work is M. Jean Pierre Casteleyn.

**Merci à :**

Till Tantau , Alain Matthes , Jim Diamond , Falk Rühl , Axel Kielhorn , Nils Fleischhacker , Michel Fruchart , Ben Vitecek

# Table des matières

<b>1</b>	<b>Chargement de TikZ</b>	<b>10</b>
<b>2</b>	<b>Les figures de base</b>	<b>10</b>
<b>3</b>	<b>Chemin</b>	<b>13</b>
3.1	Notion de Chemin . . . . .	13
3.2	Chemins dans un chemin . . . . .	14
<b>4</b>	<b>Les paramètres disponibles</b>	<b>15</b>
4.1	Épaisseur de ligne . . . . .	15
4.2	Dimensions disponibles . . . . .	15
4.3	Terminaisons de lignes . . . . .	15
4.4	Jonction de lignes . . . . .	16
4.5	Styles de ligne . . . . .	16
4.6	Remplissage en motifs . . . . .	17
4.7	Règle de remplissage . . . . .	18
4.8	Remplissage à l'aide d'une image . . . . .	18
4.9	Ombrage . . . . .	19
4.9.1	Ombrages disponibles . . . . .	19
4.9.2	Bibliothèque shadings . . . . .	19
4.10	Les extrémités . . . . .	21
4.10.1	Chargé automatiquement avec TikZ . . . . .	21
4.10.2	« library arrow.meta » . . . . .	21
	Paramètre sep . . . . .	22
	Paramètre length . . . . .	23
	Paramètre width . . . . .	24
	Paramètre inset . . . . .	25
	Paramètre angle . . . . .	26
	Paramètre scale . . . . .	26
	Paramètre arc . . . . .	26
	Paramètre slant . . . . .	26
	Paramètre reversed . . . . .	27
	Paramètre left . . . . .	28
	Paramètre right . . . . .	28
	Paramètre harpoon . . . . .	28
	Paramètre color . . . . .	29
	Paramètre fill . . . . .	29
	Paramètre open . . . . .	30
	Paramètre line cap : round or butt . . . . .	30
	Paramètre line join : round or miter . . . . .	30
	Paramètre round . . . . .	31
	Paramètre sharp . . . . .	31
	Paramètre line width . . . . .	32
	Paramètre line width' . . . . .	33
	Paramètre quick . . . . .	33
	Paramètre bending . . . . .	34
	Paramètre cap angle . . . . .	34
<b>5</b>	<b>Insertion de petites images</b>	<b>35</b>
5.1	Images créées . . . . .	35
5.2	Images prédéfinies : Marquage des angles . . . . .	37

<b>6</b>	<b>Les coordonnées</b>	<b>39</b>
6.1	Quadrillage . . . . .	39
6.2	Coordonnées . . . . .	40
6.2.1	Système de coordonnées « canvas » . . . . .	40
6.2.2	Système de coordonnées polaire « canvas » . . . . .	40
6.2.3	Système de coordonnées xyz . . . . .	40
6.2.4	Coordinate system xyz polar . . . . .	41
6.2.5	Coordonnées barycentriques . . . . .	41
6.2.6	Coordonnées nominatives : nœud . . . . .	42
6.2.7	Coordonnées relatives à un nœud . . . . .	42
6.2.8	Coordonnées relatives à deux points . . . . .	43
6.2.9	Coordonnée relative à une intersection . . . . .	43
6.2.10	Position calculée avec le module « pgfmath » . . . . .	45
6.2.11	Position calculée avec « library calc » . . . . .	45
6.2.12	Tangentes avec « library calc » . . . . .	45
6.2.13	Point à pourcentage donné . . . . .	46
6.2.14	Point à distance donnée . . . . .	46
6.2.15	Coordonnées relatives . . . . .	47
	Cartésienne . . . . .	47
	Polaire . . . . .	47
	coordonnée relative en polaire . . . . .	47
<b>7</b>	<b>Les nœuds</b>	<b>49</b>
7.1	Définition des nœuds . . . . .	49
7.2	Nom des nœuds . . . . .	49
7.3	Contenu des nœuds . . . . .	50
7.4	premier ou arrière plan . . . . .	50
7.5	Noms à préfixe ou suffixe . . . . .	50
7.6	Liaisons . . . . .	51
7.7	Étiquettes sur les nœuds . . . . .	53
7.8	Étiquettes épinglées . . . . .	54
7.9	Nœuds sur un chemin . . . . .	54
7.10	Nœuds sur un “edge” . . . . .	56
7.11	Positionnement relatif de nœuds . . . . .	56
7.12	Nœud enveloppant . . . . .	58
7.13	Cercle défini par deux points . . . . .	60
7.14	Matrice de nœuds . . . . .	61
	7.14.1 Alignement des cellules . . . . .	61
	7.14.2 Format des cellules . . . . .	62
	7.14.3 Points d’ancrage . . . . .	64
	7.14.4 Changement du séparateur . . . . .	64
7.15	Matrice de nœuds (compléments) . . . . .	64
	7.15.1 Texte dans les nœuds . . . . .	66
	7.15.2 Délimiteurs . . . . .	66
7.16	Matrice de nœuds . . . . .	67
	7.16.1 Création d’une chaîne de nœuds . . . . .	67
	7.16.2 Nœuds sur la chaîne . . . . .	68
	7.16.3 Jonction de nœuds . . . . .	69
	7.16.4 Branches . . . . .	70
<b>8</b>	<b>Constructions particulières</b>	<b>71</b>

<b>9</b>	<b>Placer son dessin</b>	<b>72</b>
9.1	Dans le texte . . . . .	72
9.1.1	Sans option de décalage . . . . .	72
9.1.2	Avec décalage nul . . . . .	72
9.1.3	Avec décalage . . . . .	72
9.2	Dans un environnement tikzpicture . . . . .	73
9.3	Dans un environnement fbox . . . . .	73
9.4	Modification du cadrage . . . . .	73
9.5	Coupure de l'image . . . . .	75
9.6	Rognage partiel . . . . .	75
9.6.1	Changement d'échelle . . . . .	75
<b>10</b>	<b>Scope</b>	<b>76</b>
10.1	Environnement Scope . . . . .	76
10.2	library scopes . . . . .	76
10.2.1	Simplification d'un environnement scope . . . . .	76
10.2.2	Portée d'un seul élément . . . . .	77
<b>11</b>	<b>Position absolue sur une page</b>	<b>78</b>
<b>12</b>	<b>Arrière plan du dessin</b>	<b>79</b>
12.1	Encadrement . . . . .	79
12.1.1	Options . . . . .	79
12.1.2	Style . . . . .	79
12.2	Encadrement partiel . . . . .	79
12.2.1	Style . . . . .	80
12.2.2	Quadrillage . . . . .	80
12.2.3	Style . . . . .	80
12.2.4	Encadrement et quadrillage . . . . .	80
<b>13</b>	<b>Créer ses couleurs</b>	<b>81</b>
13.1	Couleurs de base . . . . .	81
13.2	Mélange de couleurs . . . . .	81
13.3	Créer son nom de couleur . . . . .	81
13.3.1	A pourcentage de rouge vert et bleue . . . . .	81
13.3.2	A partir d'une couleur existante . . . . .	81
<b>14</b>	<b>Opacité</b>	<b>82</b>
14.1	Blend Modes . . . . .	83
14.2	Fading . . . . .	84
14.2.1	Modèles prédéfinis . . . . .	84
14.2.2	Création de décoloration avec tikzfadingfrompicture . . . . .	84
14.3	Création de décoloration avec tikzfading . . . . .	86
14.3.1	Modification de la décoloration . . . . .	86
14.4	Transparency Groups . . . . .	87
<b>15</b>	<b>Créer ses commandes</b>	<b>88</b>
<b>16</b>	<b>Créer ses styles</b>	<b>89</b>
16.1	Styles sans variable . . . . .	89
16.2	Styles avec variable . . . . .	89

<b>17 Mettre du texte en valeur</b>	<b>90</b>
17.1 Dans un nœud de Tikz . . . . .	90
17.1.1 Options . . . . .	90
17.1.2 Taille minimale des noeuds . . . . .	90
17.2 Dans un nœud à formes géométriques . . . . .	91
17.2.1 Formes disponibles . . . . .	91
17.2.2 Options . . . . .	91
17.3 Dans un nœud en forme de symboles . . . . .	94
17.3.1 Formes disponibles . . . . .	94
17.3.2 Options . . . . .	94
17.4 Dans un nœud en forme de flèche . . . . .	96
17.4.1 Formes disponibles . . . . .	96
17.4.2 Options . . . . .	96
17.5 Dans un nœud en forme de bulle . . . . .	98
17.5.1 Formes disponibles . . . . .	98
17.5.2 Options . . . . .	98
17.6 Dans un nœud en diverses formes diverses . . . . .	100
17.6.1 Formes disponibles . . . . .	100
17.6.2 Options . . . . .	100
Options pour “rounded rectangle ” . . . . .	100
Options pour “chamfered rectangle ” . . . . .	100
17.7 Nœuds à plusieurs parties . . . . .	102
17.8 Mise en forme du texte . . . . .	104
17.8.1 Position . . . . .	104
17.8.2 Couleur et fontes . . . . .	105
17.8.3 Taille des fontes . . . . .	105
17.9 Positions prédéfinies sur un nœud . . . . .	105
17.9.1 pour l’ensemble des nœuds . . . . .	105
17.9.2 spécifique à un nœud . . . . .	107
<b>18 Decorations</b>	<b>114</b>
18.1 Library “decorations.pathmorphing ” . . . . .	114
18.1.1 “lineto ” . . . . .	115
18.1.2 “straight zigzag ” . . . . .	115
18.1.3 “random steps ” . . . . .	115
18.1.4 “saw ” . . . . .	116
18.1.5 “zigzag ” . . . . .	117
18.1.6 “bent ” . . . . .	117
18.1.7 “bumps ” . . . . .	118
18.1.8 “coil ” . . . . .	118
18.1.9 “curveto ” . . . . .	119
18.1.10 “snake ” . . . . .	119
18.2 Library “decorations.pathreplacing ” . . . . .	121
18.2.1 “border ” . . . . .	121
18.2.2 “brace ” . . . . .	121
18.2.3 ” expanding waves ” . . . . .	122
18.2.4 “moveto ” . . . . .	122
18.2.5 “ticks ” . . . . .	122
18.2.6 ” waves ” . . . . .	123
18.2.7 “show path construction ” . . . . .	124
18.3 Library “decorations.markings ” . . . . .	126
18.3.1 Sa marque à une position . . . . .	126
18.3.2 Ses marques : origine, fin et pas . . . . .	126
18.3.3 Marque avec un nœud contenant du texte . . . . .	126
18.3.4 Marque avec un nœud contenant une image . . . . .	127

18.3.5	Numérotation des marques et affectation d'un nom	127
18.3.6	Distance des nœuds	127
18.3.7	Nœud sur une liaison	128
18.3.8	Arrow Tip Markings	128
18.4	Library "decorations.footprints"	129
18.5	Library "decorations.shapes"	130
18.5.1	Introduction	130
18.5.2	"shape backgrounds"	130
	Orientation	131
18.6	Library "decorations.text"	134
18.7	Library "decorations.fractals"	136
18.8	Applications	137
18.8.1	Décoration d'un nœud	137
18.8.2	Décoration de liaisons de noeuds	137
18.8.3	Décoration d'un graphe	138
18.8.4	Décorations variables	138
18.8.5	Décoration partielle	138
18.8.6	Paramètres globaux ou particuliers	140
18.8.7	Tracer le chemin et sa décoration avec "Postaction"	140
<b>19</b>	<b>Insertion images dans un environnement TikZ</b>	<b>141</b>
19.0.1	Dans un noeud	141
19.0.2	En déclarant l'image dans pgf	141
<b>20</b>	<b>Trait à main levée</b>	<b>141</b>
<b>21</b>	<b>Effets spéciaux</b>	<b>142</b>
21.1	Le peuple TikZ	142
21.1.1	Personages disponibles	142
21.1.2	Options	143
21.1.3	Point d'ancrage spécifique	143
21.1.4	Couleurs	143
21.2	Ducks	149
21.2.1	Options	149
21.2.2	Canards aléatoires	152
21.2.3	Coordonnées	153
21.2.4	Rayures	153
21.3	symbol	155
<b>22</b>	<b>Créer un graphe</b>	<b>159</b>
22.1	Graphe avec TikZ	159
22.1.1	Graphe à partir d'une liste de points	159
22.1.2	Graphe à partir partir d'un fichier de données	159
22.1.3	Les types de graphes	160
22.1.4	Graphe à partir d'une fonction	162
22.1.5	Fonctions paramétriques	162
22.2	Marques	162
22.2.1	Marques avec TikZ	162
22.2.2	Marques personnalisées avec text mark	163
22.2.3	Marques avec l'extension plotmarks	164
22.3	Graphes avec Gnuplot	164

<b>23 Créer un graphe avec pgfplot</b>	<b>165</b>
23.1 Courbes 2 D . . . . .	165
23.1.1 Axes . . . . .	165
23.2 Tracé de la courbe . . . . .	165
23.2.1 Dimension unitaire en X et Y . . . . .	166
23.2.2 Type de graphiques . . . . .	166
23.3 Habillage du graphe . . . . .	169
23.3.1 Titres . . . . .	169
23.3.2 Légende . . . . .	169
23.3.3 Taille du graphe . . . . .	170
23.3.4 Quadrillage . . . . .	170
<b>24 Courbes 3D</b>	<b>172</b>
24.0.1 Axes . . . . .	172
24.0.2 Tracé de la courbe . . . . .	173
24.0.3 Aspect . . . . .	173
24.0.4 Point de vue . . . . .	175
<b>25 Les Tableaux de variation</b>	<b>176</b>
25.1 Déclaration du tableau . . . . .	176
25.1.1 Options . . . . .	176
25.2 Création d'une ligne de signes . . . . .	177
25.3 Création d'une ligne de variations . . . . .	178
<b>26 Les répétitions</b>	<b>182</b>
26.1 Répétition à 1 variable . . . . .	182
26.2 Répétition à 2 variables . . . . .	182
26.3 Répétition à 2 variables - boucles imbriquées . . . . .	183
<b>27 Dessin robotisé</b>	<b>184</b>
<b>28 Les diagrammes arborescents</b>	<b>186</b>
28.1 Structure . . . . .	186
28.2 Orientation . . . . .	186
28.3 Distance . . . . .	187
28.4 Distance père fils . . . . .	187
28.5 Distance père fils . . . . .	188
28.6 Personnalisation des noeuds . . . . .	189
28.6.1 Nom des noeuds . . . . .	189
28.6.2 Omission d'un noeud . . . . .	190
28.6.3 Modification du point d'accrochage . . . . .	190
28.6.4 Liaison . . . . .	191
28.6.5 Étiquettes sur liaisons . . . . .	191
28.6.6 Personnalisation des liaisons . . . . .	192
28.7 Options supplémentaires avec « library trees » . . . . .	193
28.7.1 Positions d'un fils et de deux fils . . . . .	193
28.7.2 Liaison angulaire . . . . .	193
28.7.3 Liaisons en fourchette . . . . .	194
<b>29 Les schemas électriques</b>	<b>195</b>
29.1 Symboles . . . . .	195
29.2 Annotations . . . . .	197
29.3 Exemple . . . . .	201
<b>30 Les circuits logiques</b>	<b>201</b>





<b>31 Optique</b>	<b>205</b>
31.1 Éléments optiques . . . . .	205
31.1.1 Éléments optiques disponibles . . . . .	205
31.1.2 Paramètres . . . . .	205
31.1.3 Ancres . . . . .	208
31.2 Lampes et capteurs . . . . .	209
31.2.1 Disponibles . . . . .	209
31.2.2 Paramètres . . . . .	210
31.2.3 Points d'ancrages . . . . .	211
31.3 Outils . . . . .	212
31.3.1 Marquer des rayons . . . . .	212
31.3.2 Cotation . . . . .	213
<b>32 Les animations</b>	<b>215</b>
32.1 Animation à partir de fichiers d'image . . . . .	215
32.2 Animateinline . . . . .	215
32.3 Multiframe . . . . .	216
<b>33 Les modules étudiés dans ce document</b>	<b>217</b>

# 1 Chargement de TikZ

Charger l'extension : `\usepackage{tikz}`

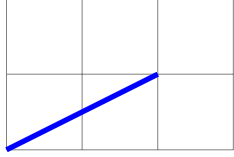
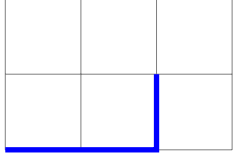
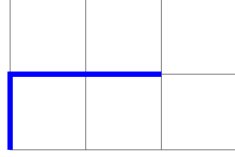
## 2 Les figures de base

<code>\draw (0,0) -- (2,1);</code> <span style="font-size: small; border: 1px solid black; padding: 1px;">PGFmanual section : 14-2</span>	<code>\draw (0,0)  - (2,1);</code>	<code>\draw (0,0)  -  (2,1);</code>
		

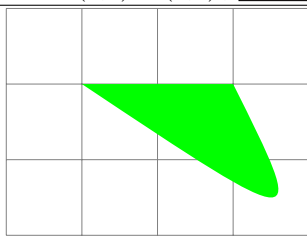
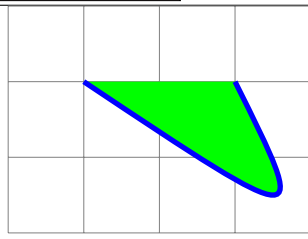
<code>\draw (0,2) .. controls (3,0) .. (2,2);</code> <span style="font-size: small; border: 1px solid black; padding: 1px;">PGFmanual section : 14-3</span>		
		
<code>\draw</code>	<code>\fill</code>	<code>\filldraw</code>

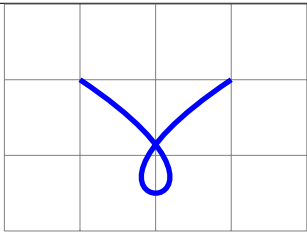
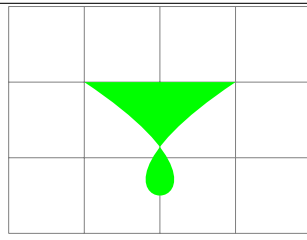
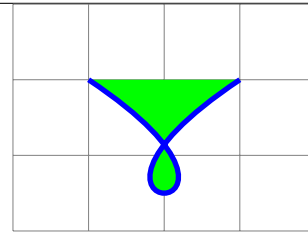
<code>\draw (0,2) .. controls (3,0) and (-1,0) .. (2,2);</code> <span style="font-size: small; border: 1px solid black; padding: 1px;">PGFmanual section : 14-3</span>		
		
<code>\draw</code>	<code>\fill</code>	<code>\filldraw</code>

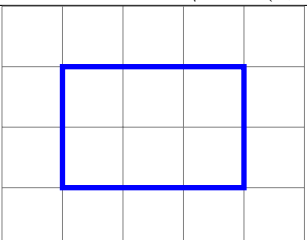
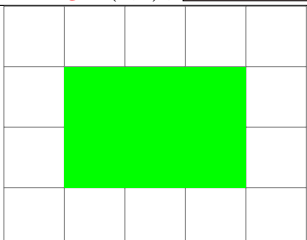
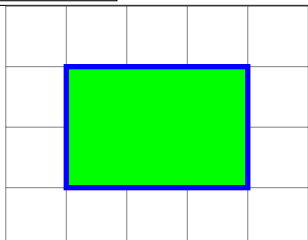
<code>\draw (0,0) rectangle (3,2);</code> <span style="font-size: small; border: 1px solid black; padding: 1px;">PGFmanual section : 14-4</span>		
		
<code>\draw</code>	<code>\fill</code>	<code>\filldraw</code>

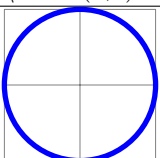
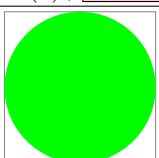
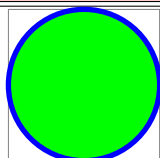
<code>\draw (1,1) circle (1);</code> <span style="font-size: small; border: 1px solid black; padding: 1px;">PGFmanual section : 14-6</span>		
		
<code>\draw</code>	<code>\fill</code>	<code>\filldraw</code>

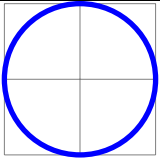
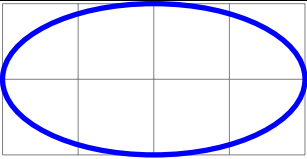
<code>\draw (1,1) circle [radius=1cm];</code>	<code>\draw (1,1) ellipse [x radius=2cm,y radius=1cm]</code>
	
radius=1cm	x radius=2cm,y radius=1cm

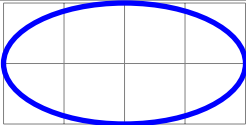
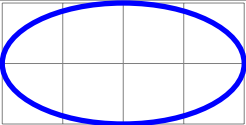
<code>\draw (1,1) circle (2 and 1);</code>	<code>\draw (1,1) ellipse (2 and 1);</code>
	

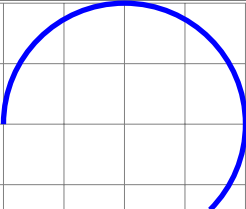
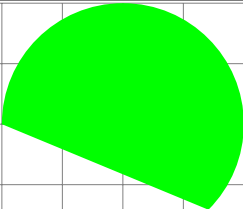
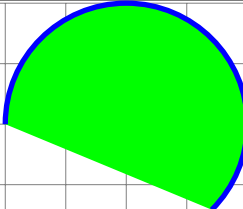
<code>\draw (-2,0) arc (180 :-45:2);</code> <a href="#">PGFmanual section : 14-7</a>		
		
<code>\draw</code>	<code>\fill</code>	<code>\filldraw</code>

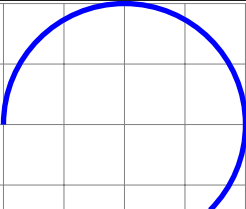
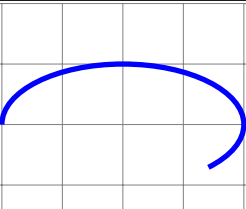
<code>\draw (-2,0) arc [start angle=180, end angle=-45,radius=1]</code>	<code>\draw (-2,0) arc (180 :-45:2 and 1)</code>
	
radius=1	x radius=1,y radius=.5

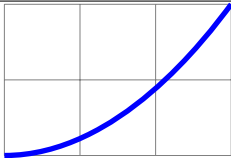
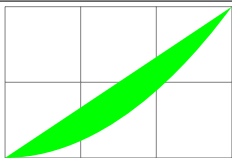
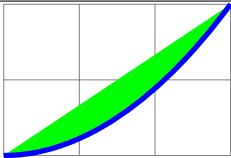
<code>\draw (0,0) parabola (3,2);</code> <a href="#">PGFmanual section : 14-9</a>		
		
<code>\draw</code>	<code>\fill</code>	<code>\filldraw</code>

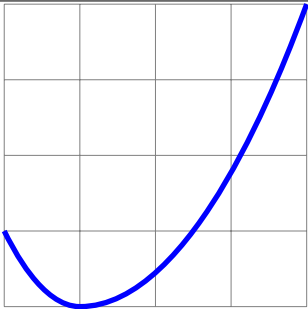
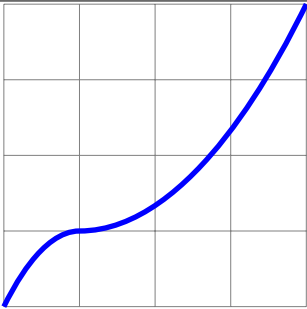
	
<code>\draw(0,1) parabola bend (1,0) (4,4);</code>	<code>\draw(0,0) parabola[bend pos=0.25] (4,4);</code>

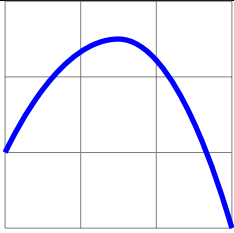
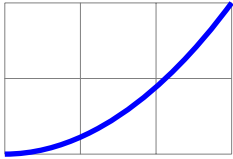
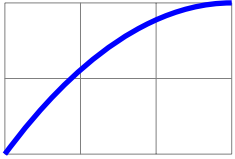
<code>\draw(0,1) parabola [parabola height=2cm] (3,0);</code>	<code>\draw(0,0) parabola[bend at start] (3,2);</code>	
		
	<code>[bend at start]</code>	<code>[bend at end]</code>

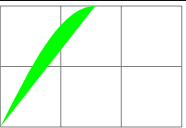
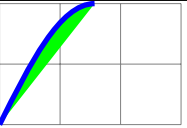
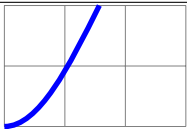
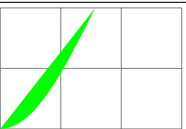
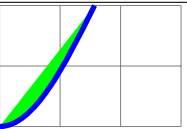
<code>\draw (0,0) sin (1.57,2);</code> <a href="#">PGFmanual section : 14-10</a>		
		
<code>\draw</code>	<code>\fill</code>	<code>\filldraw</code>
		
<code>\draw (0,0) cos (1.57,2);</code>		

[PGFmanual section : 14-13](#)

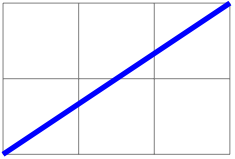
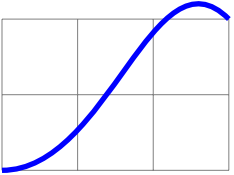
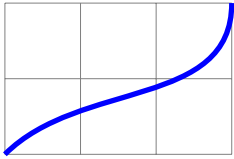
		
<code>\draw (0,0) to (3,2);</code>	<code>\draw[out=0] (0,0) to (3,2);</code>	<code>\draw[in=-90] (0,0) to (3,2);</code>
voir section 7.6 page 51		

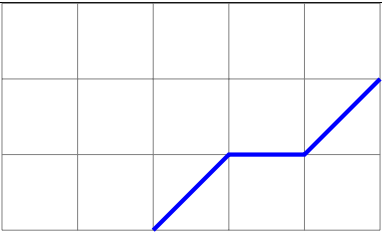
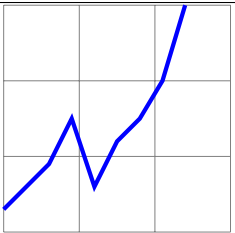
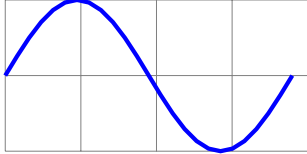
<b>Dessin avec plot</b> <a href="#">PGFmanual section : 14-12</a> <a href="#">PGFmanual section : 22</a>		
une liste de coordonnées	un fichier de coordonnées	une équation mathématique
		
plot coordinates {(2,0) (3,1) (4,1) (5,2)}	plot file {table.dat}	plot (\x,{sin(\x)})
voir page 159		

### 3 Chemin

#### 3.1 Notion de Chemin

PGFmanual section : 14

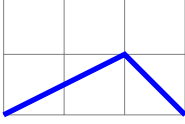
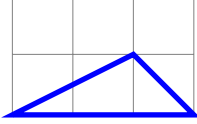
	
<code>\draw (0,0) -- (2,1) -- (3,0);</code>	<code>\draw (0,0) -- (2,1) -- (3,0) -- cycle;</code>

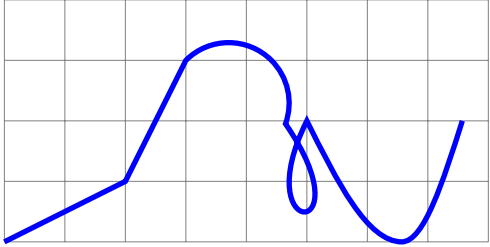
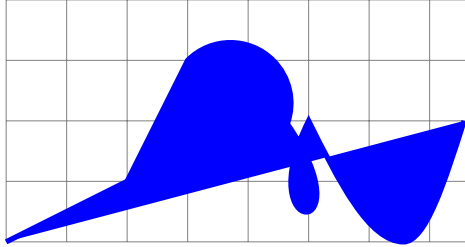
<code>\draw (0,0) -- (2,1) -- (3,3) arc (135 :-20:1) .. controls (6,0) and (4,0) .. (5,2) sin (6.57,0) cos (7.57,2);</code>	
	
<code>\draw</code>	<code>\filldraw</code>

PGFmanual section : 14-5

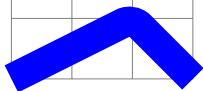
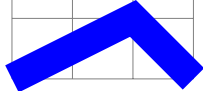
	
<code>\draw [rounded corners] (0,0) -- (2,1) -- (3,0);</code>	<code>\draw [sharp corners] (0,0) -- (2,1) -- (3,0);</code>

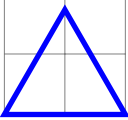
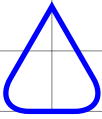
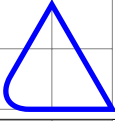
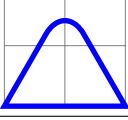
	<code>\draw [rounded corners=0.5cm] (0,0) -- (1,1.732) -- (2,0) -- cycle;</code>
	<code>\draw (0,0) -- (1,1.732) [rounded corners=0.5cm] -- (2,0) -- cycle;</code>
	<code>\draw (0,0) -- (1,1.732) -- (2,0)[rounded corners=0.5cm] -- cycle;</code>
	<code>\draw [rounded corners=0.5cm] (0,0) -- (1,1.732)[sharp corners] -- (2,0) -- cycle;</code>

PGFmanual section : 14-2-2

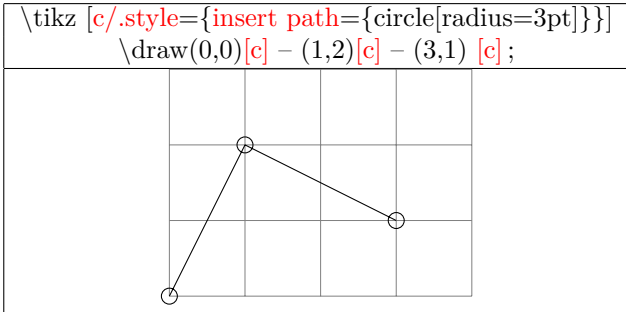
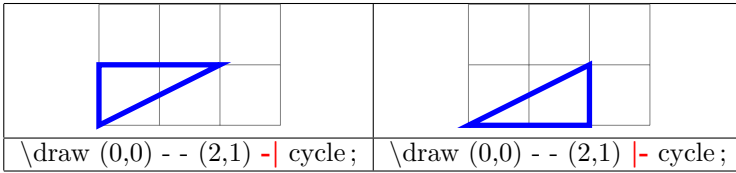

### Coupure de chemin PGFmanual section : 14-1

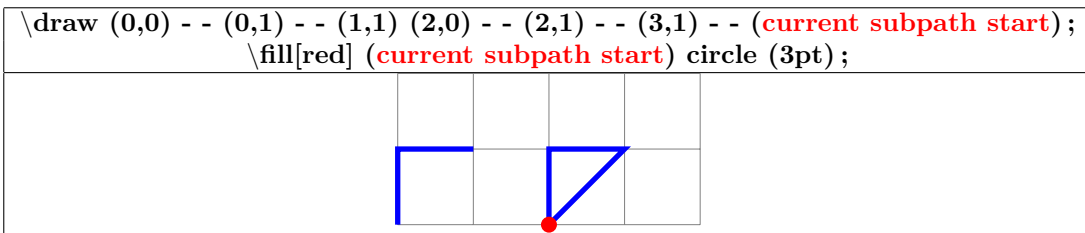
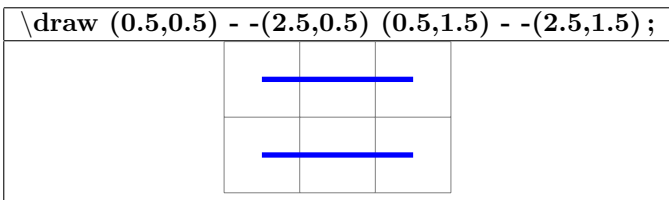

### 3.2 Chemins dans un chemin



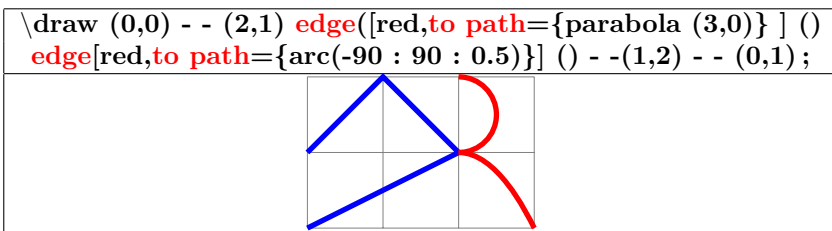
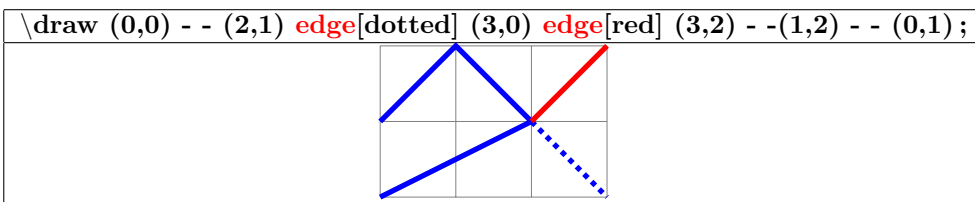





PGFmanual section : 17-12







## 4 Les paramètres disponibles

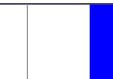
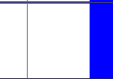

### 4.1 Épaisseur de ligne

PGFmanual section : 15-3-1

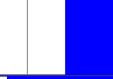
<code>\tikz \draw[line width=.2cm] (0,0) - - (1,1) ;</code>			
			
<code>[line width=.2cm]</code>	<code>[ultra thin]</code> (0.1pt)	<code>[very thin]</code> (0.2pt)	<code>[thin]</code> (0.4pt)
			
<code>[semithick]</code> (0.6pt)	<code>[thick]</code> (0.8pt)	<code>[very thick]</code> (1.2pt)	<code>[ultra thick]</code> (1.6pt)

### 4.2 Dimensions disponibles

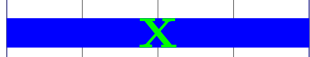
	<code>\draw[line width=10pt] (2,0) to (2,1) ;</code>
	<code>\draw[line width=10bp] (2,0) to (2,1) ;</code>
	<code>\draw[line width=10mm] (2,0) to (2,1) ;</code>
	<code>\draw[line width=1cm] (2,0) to (2,1) ;</code>
	<code>\draw[line width=1in] (2,0) to (2,1) ;</code>

	<code>\draw[line width=1ex] (0,0.5) to (4,.5) ;</code>
	<code>\Huge \draw[line width=1ex] (0,0.5) to (4,.5) ;</code>
	<code>\draw[line width=1em] (2,0) to (2,1) ;</code>
	<code>\Huge \draw[line width=1em] (2,0) to (2,1) ;</code>

### 4.3 Terminaisons de lignes

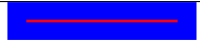
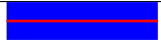
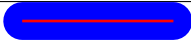
		
<code>[line cap=rect]</code>	<code>[line cap=butt]</code>	<code>[line cap=round]</code>

#### 4.4 Jonction de lignes

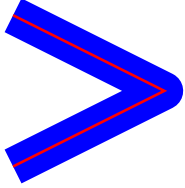
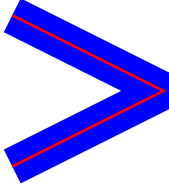
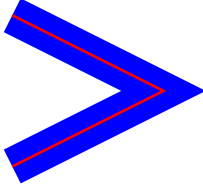

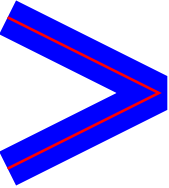
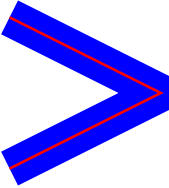
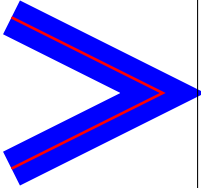
<code>\draw[line join=round] (0,0) -- (2,1) -- (0,2);</code>		
		
<code>[line join=round]</code>	<code>[line join=bevel]</code>	<code>[line join=miter]</code>

<code>\draw[miter limit=1] (0,0) -- (2,1) -- (0,2);</code> (Par défaut : : miter limit=10)		
		
<code>miter limit=1</code>	<code>miter limit=2</code>	<code>miter limit=3</code>

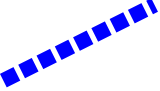
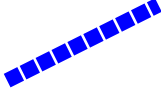
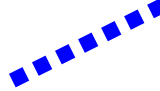
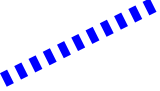
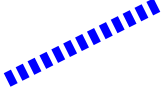
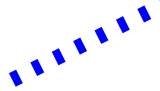
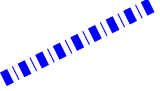
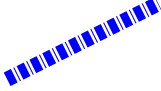
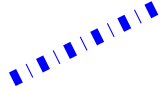
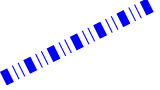
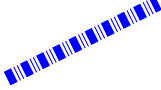
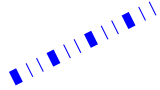

#### 4.5 Styles de ligne



PGFmanual section : 15-3-2

<code>\tikz \draw[solid,line width=2mm] (0,0) -- (2,1);</code>		
		
<code>[solid]</code>		
		
<code>[dotted]</code>	<code>[densely dotted]</code>	<code>[loosely dotted]</code>
		
<code>[dashed]</code>	<code>[densely dashed]</code>	<code>[loosely dashed]</code>
		
<code>[dash dot]</code>	<code>[densely dash dot]</code>	<code>[loosely dash dot]</code>
		
<code>[dash dot dot]</code>	<code>[densely dash dot dot]</code>	<code>[loosely dash dot dot]</code>

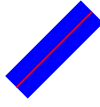
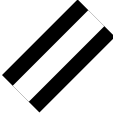
<code>[dash pattern=on 1cm off 0.25cm on 0.25cm off 0.5cm]</code>

<code>[dash pattern=on 1cm off .25cm on .25cm off .5cm,dash phase=1cm]</code>









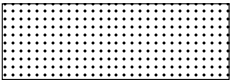

<code>\tikz \draw[line width=.2cm,double] (0,0) -- (1,1);</code>			
			
<b>double</b>	<code>draw=blue,double=red</code>	<code>double distance=.3cm</code>	<code>double distance between line centers=.3cm</code>

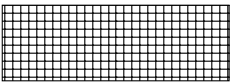
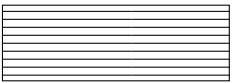
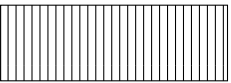
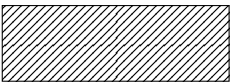

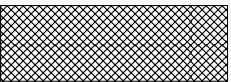

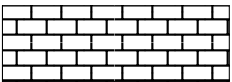

<code>\Huge = \tikz \draw[double equal sign distance] (0,0) -- (4,0);</code>	
	
<code>\Huge</code>	<code>\large</code>

#### 4.6 Remplissage en motifs

Charger l'extension : `\usetikzlibrary{patterns}`

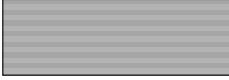
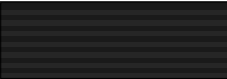
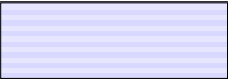
<code>\draw[pattern= dots ] (0,0) -- (3,1);</code>		
		
<b>dots</b>	<b>fivepointed stars</b>	<b>sixpointed stars</b>
		
<b>grid</b>	<b>horizontal lines</b>	<b>vertical lines</b>
		
<b>north east lines</b>	<b>north west lines</b>	<b>rosshatch</b>
		
<b>crosshatch dots</b>	<b>bricks</b>	<b>checkerboard</b>

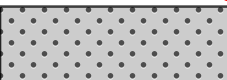
<code>\draw[pattern=fivepointed stars,pattern color=red] (0,0) rectangle (3,1);</code>

<code>\draw [pattern=checkerboard light gray ] (0,0) - - ((3,2) ;</code>		
		
<code>checkerboard light gray</code>	<code>horizontal lines light gray</code>	<code>horizontal lines gray</code>
		
<code>horizontal lines dark gray</code>	<code>horizontal lines light blue</code>	<code>horizontal lines dark blue</code>
		
<code>crosshatch dots gray</code>	<code>crosshatch dots light steel blue</code>	

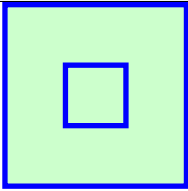
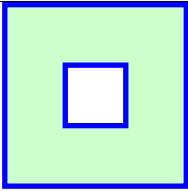
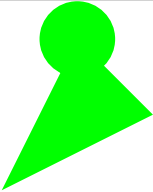
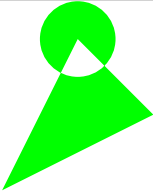
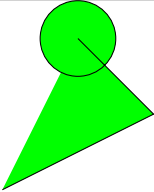
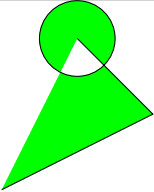

#### 4.7 Règle de remplissage

PGFmanual section : 15-5-2

nonzero rule (Par défaut : )			
			
<code>\filldraw [fill=green !20]</code> <code>(0,0) - - (0,3) - - (3,3) - - (3,0) - - cycle</code> <code>(1,1) - - (1,2) - - (2,2) - - (2,1) - - cycle ;</code>		<code>\filldraw [fill=green !20]</code> <code>(0,0) - - (0,3) - - (3,3) - - (3,0) - - cycle</code> <code>(1,1) - - (2,1) - - (2,2) - - (1,2) - - cycle ;</code>	
even odd rule			
<code>\[fill=green] (0,0) - - (2,1) - - (1,2) circle (.5cm) ;</code>		<code>\filldraw[fill=green] (0,0) - - (2,1) - - (1,2) circle (.5cm) ;</code>	
			
<code>[fill=green]</code>	<code>[even odd rule,fill=green]</code>	<code>[fill=green]</code>	<code>[even odd rule,fill=green]</code>

#### 4.8 Remplissage à l'aide d'une image

PGFmanual section : 15-6

<code>\draw [path picture={ \node at (path picture bounding box.center)</code> <code>{\includegraphics[height=3cm]{tiger}} ;}] (0,1) circle (1) ;</code>		
		
<code>(0,1) circle (1)</code>	<code>(0,0) - - (-1,1) - - (0,2) - - (1,1) - - cycle</code>	<code>(1,0) parabola[parabola height=2cm] (3,0)</code>

<pre>\draw [path picture={ \node at (path picture bounding box.north)   {\includegraphics[height=3cm]{tiger}};}] (0,1) circle (1);</pre>				
north	south	east	west	south east

## 4.9 Ombrage

### 4.9.1 Ombrages disponibles

PGFmanual section : 15-7

<code>\shade (0,0) rectangle (3,1);</code>	<code>\shadedraw (0,0) rectangle (3,1);</code>

<code>\shadedraw[shading=axis](0,0) rectangle (3,1);</code>		
axis	radial	ball

<code>[left color=red]</code>	<code>[right color=green]</code>	<code>left color=red,right color=green</code>
<code>[top color=red]</code>	<code>[bottom color=green]</code>	<code>middle color=red</code>





<code>shading angle=90</code>	<code>right color=green</code> <code>[shading angle=45]</code>	<code>left color=red</code> <code>shading angle=-45</code>



<code>inner color=red</code>	<code>outer color=green</code>	<code>inner color=red outer color=green</code>

## 4.9.2 Bibliothèque shadings

PGFmanual section : 65

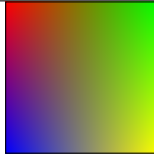
Charger l'extension : `\usetikzlibrary{shadings}`

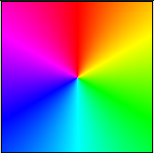



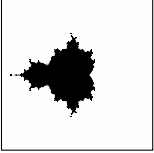

<code>\shadedraw[upper left=red] (0,0) rectangle (2,2);</code>				
				
<code>upper left=red</code>	<code>upper right=green</code>	<code>lower left=blue</code>	<code>lower right=yellow</code>	

<code>\shadedraw[shading=color wheel] (0,0) rectangle (2,2);</code>		
		
<code>shading=color wheel</code>	<code>shading=color wheel black center</code>	<code>shading=color wheel white center</code>

<code>shading=Mandelbrot set</code>



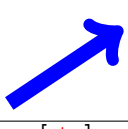
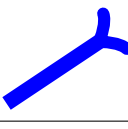
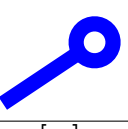
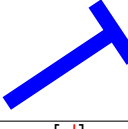
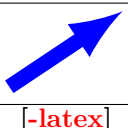
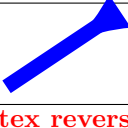

## 4.10 Les extrémités

### 4.10.1 Chargé automatiquement avec TikZ

<code>\tikz \draw[-&gt;,line width=.2cm,blue] (0,0) -- (1.5,1);</code>			
			
<code>[-&gt;]</code>	<code>[&lt;-]</code>	<code>[&lt;-&gt;]</code>	<code>[&gt;-&gt;]</code>
			
<code>[-to]</code>	<code>[-to reversed]</code>	<code>[-o]</code>	<code>[- ]</code>
			
<code>[-latex]</code>	<code>[-latex reversed]</code>	<code>[-stealth]</code>	<code>[-stealth reversed]</code>

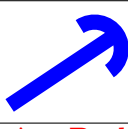
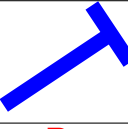
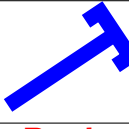
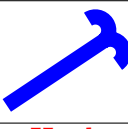
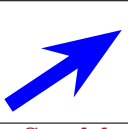
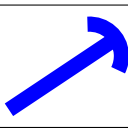
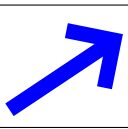
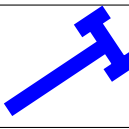
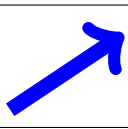
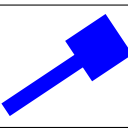
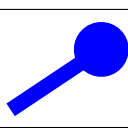
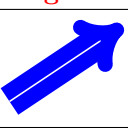
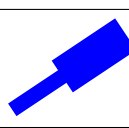
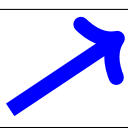
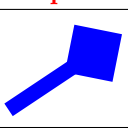
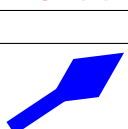
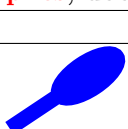
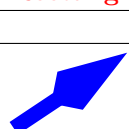
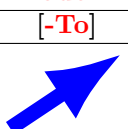
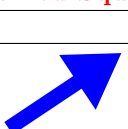

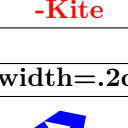
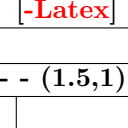
### 4.10.2 « library arrow.meta »

Charger l'extension : `\usetikzlibrary{arrows.meta}`

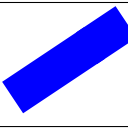
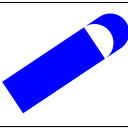
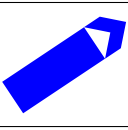
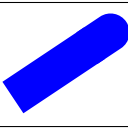
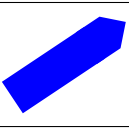

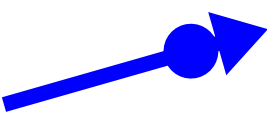
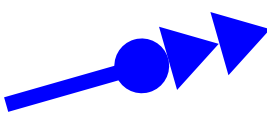

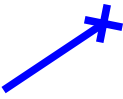

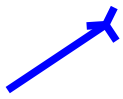
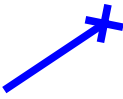
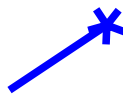
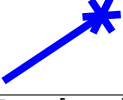
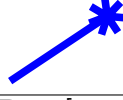
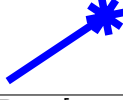
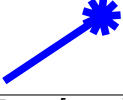
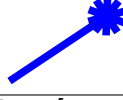



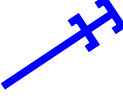

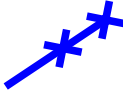

<code>\tikz \draw[-Arc Barb,line width=.2cm,blue] (0,0) -- (1.5,1);</code>				
				
<code>-Arc Barb</code>	<code>-Bar</code>	<code>-Bracket</code>	<code>-Hooks</code>	<code>-Stealth</code>
				
<code>-Parenthesis</code>	<code>-Straight Barb</code>	<code>-Tee Barb</code>	<code>-Classical TikZ Rightarrow</code>	<code>-Square</code>
				
<code>-Circle</code>	<code>-Implies, double</code>	<code>-Rectangle</code>	<code>-Computer Modern Rightarrow</code>	<code>-Turned Square</code>
				
<code>-Diamond</code>	<code>-Ellipse</code>	<code>-Kite</code>	<code>[-To]</code>	<code>[-Latex]</code>
				
<code>-Triangle</code>				

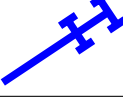
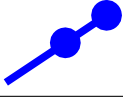
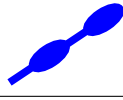

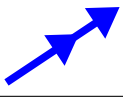

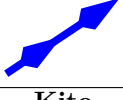



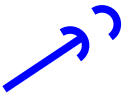
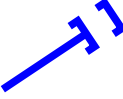
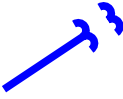
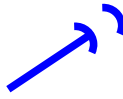

<code>\tikz \draw[-Butt Cap,line width=.2cm,blue] (0,0) -- (1.5,1);</code>				
				
<code>-Butt Cap</code>	<code>-Fast Round</code>	<code>-Fast Triangle</code>	<code>-Round Cap</code>	<code>-Triangle Cap</code>

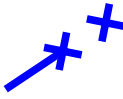
<code>\tikz \draw[Triangle-Circle,line width=.2cm,blue] (0,0) - - (3.5,1);</code>		
		
<code>Triangle-Circle</code>	<code>{Circle[] Triangle[]}</code>	<code>{Circle[] . Triangle[] Triangle[] }</code>

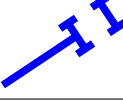



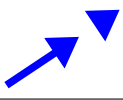
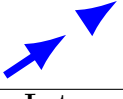
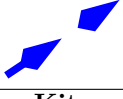
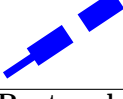
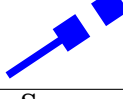

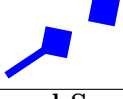
<code>\tikz \draw[-Rays],line width=.1cm,blue] (0,0) - - (1.5,1);</code>				
				
<code>Rays</code>	<code>{Rays[n=2]}</code>	<code>{Rays[n=3]}</code>	<code>{Rays[n=4]}</code>	<code>{Rays[n=5]}</code>
				
<code>{Rays[n=6]}</code>	<code>{Rays[n=7]}</code>	<code>{Rays[n=8]}</code>	<code>{Rays[n=9]}</code>	<code>{Rays[n=10]}</code>

Paramètre sep [PGFmanual section : 16-4-2](#)

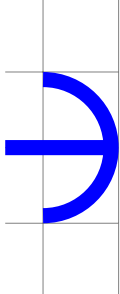
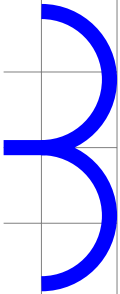
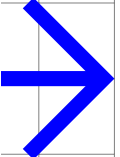
<code>\tikz \draw[-{Arc Barb[sep=.25cm] Arc Barb[ ]},line width=.1cm,blue] (0,0) - - (1.5,1);</code>					
					
<code>Arc Barb</code>	<code>Bracket</code>	<code>Hooks</code>	<code>Parenthesis</code>	<code>Classical TikZ Rightarrow</code>	<code>Rays</code>
					
<code>Straight Barb</code>	<code>Tee Barb</code>	<code>Circle</code>	<code>Ellipse</code>	<code>Computer Modern Rightarrow</code>	<code>Triangle</code>
					
<code>Latex</code>	<code>Kite</code>	<code>Rectangle</code>	<code>Square</code>	<code>Stealth</code>	<code>Turned Square</code>

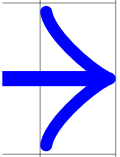
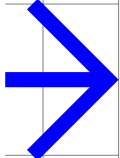
<code>\tikz \draw[-{Arc Barb[sep=.25cm] • Arc Barb[ ]},line width=.1cm,blue] (0,0) - - (1.5,1);</code>					
					
<code>Arc Barb</code>	<code>Bracket</code>	<code>Hooks</code>	<code>Parenthesis</code>	<code>Classical TikZ Rightarrow</code>	<code>Rays</code>
					
<code>Straight Barb</code>	<code>Tee Barb</code>	<code>Circle</code>	<code>Ellipse</code>	<code>Computer Modern Rightarrow</code>	<code>Triangle</code>
					
<code>Latex</code>	<code>Kite</code>	<code>Rectangle</code>	<code>Square</code>	<code>Stealth</code>	<code>Turned Square</code>

Paramètre length [PGFmanual section : 16-3-1](#)

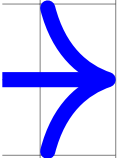
<code>\tikz \draw[-{Arc Barb[length=1cm]},line width=.2cm,blue] (0,0) -- (1,1);</code>					
					
Arc Barb	Hooks	Straight Barb	Tee Barb	Latex	Classical TikZ Rightarrow
					
Straight Barb	Diamond	Ellipse	Kite	Circle	Computer Modern Rightarrow

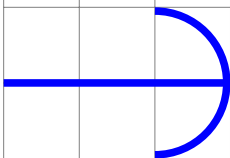
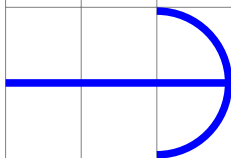
<code>\tikz \draw[-{Arc Barb[length=0cm 10]},line width=.1cm,blue] (0,0) -- (3,1);</code>	
	
<code>[length=0cm 10]</code>	<code>[length=.5cm 5]</code>
$0\text{cm} + 10 \times .1\text{cm} = 1\text{cm}$	$.5\text{cm} + 5 \times .1\text{cm} = 1\text{cm}$

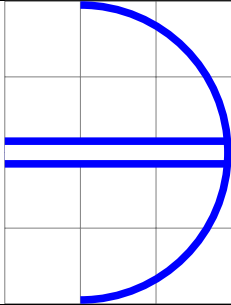
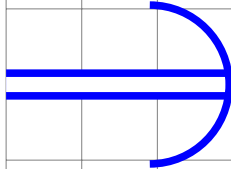
<code>\tikz \draw[-{Arc Barb[length=0cm 5]},line width=.1cm,blue,double,double distance = 2 mm] (0,0) -- (3,1);</code>	
	
<code>[length=0cm 5]</code>	<code>[length=0cm 5 .6]</code>
$0\text{cm} + 5 \times (.1\text{cm} + 2\text{ mm} + .1\text{cm}) = 2\text{cm}$	$0\text{cm} + 5 \times (.6 \times .1\text{cm} + (1-.6)(.1\text{cm} + 2\text{ mm} + .1\text{cm})) = 11\text{ mm}$

Paramètre width PGFmanual section : 16-3-1

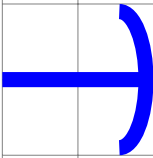
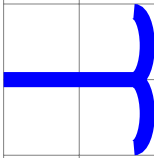
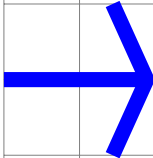
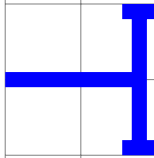
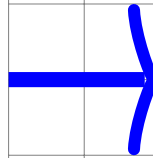
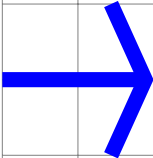
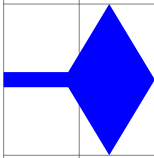
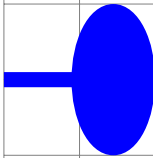
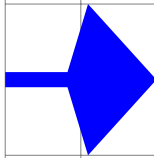
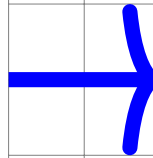
<code>\tikz \draw[-{Arc Barb[width=2cm]},line width=.2cm,blue] (0,0) -- (1,1);</code>				
				
Arc Barb	Hooks	Straight Barb	Tee Barb	Classical TikZ Rightarrow
				
Straight Barb	Diamond	Ellipse	Kite	Computer Modern Rightarrow

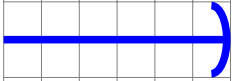
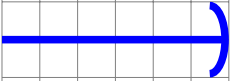
<code>\tikz \draw[-{Arc Barb[width=0cm 10]},line width=.1cm,blue] (0,0) -- (3,1);</code>	
	
[width=0cm 10]	[width=.5cm 5]
$0\text{cm} + 10 \times .1\text{cm} = 1\text{cm}$	$.5\text{cm} + 5 \times .1\text{cm} = 1\text{cm}$

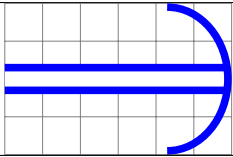
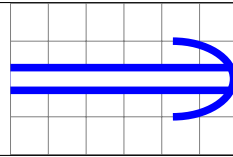
<code>\tikz \draw[-{Arc Barb[width=0cm 5 ]},line width=.1cm,blue,double,double distance = 2 mm] (0,0) -- (3,1);</code>	
	
[width=0cm 5 ]	[width=0cm 5 .6 ]
$0\text{cm} + 5 \times (.1\text{cm} + 2\text{ mm} + .1\text{cm}) = 2\text{cm}$	$0\text{cm} + 5 \times (.6 \times .1\text{cm} + (1-.6)(.1\text{cm} + 2\text{ mm} + .1\text{cm})) = 11\text{ mm}$

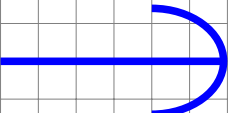
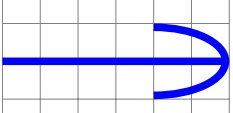
<code>\tikz \draw[-{Arc Barb[length=1cm,width=0cm 1.5]},line width=.1cm,blue] (0,0) -- (3,1);</code>	
	
[width'=0cm 1.5]	[width'=.5cm .5]
$0\text{cm} + 1.5 \times 1\text{cm} = 1.5\text{cm}$	$.5\text{cm} + .5 \times 1\text{cm} = 1\text{cm}$



<code>\tikz \draw[-{Arc Barb[length=1cm,width'=0cm 1.5 ]},line width=.1cm,blue,double,double distance = 2 mm]</code>	
<code>[width'=0cm 1.5 ]</code>	<code>[width'=0cm 1.5 .6 ]</code>
$0\text{cm} + 1.5 \times 1\text{cm} = 1.5\text{cm}$	$0\text{cm} + 1.5 \times (.6 \times 1\text{cm} + (1-.6)(1\text{cm} + 2\text{ mm} + 1\text{cm})) = 11\text{ mm}$

Paramètre inset [PGFmanual section : 16-3-1](#)

<code>\tikz \draw[-{Tee Barb[inset=0pt]},line width=.2cm,blue] (0,0) -- (1,1);</code>		
<code>Tee Barb[inset=0pt]</code>	<code>Kite[inset=0pt]</code>	<code>Stealth[inset=0pt]</code>
<code>Tee Barb[inset=1cm]</code>	<code>Kite[inset=1cm]</code>	<code>Stealth[inset=.5cm]</code>

<code>\tikz \draw[-{Fast Round[inset=1cm]},line width=.2cm,blue] (0,0) -- (1,1);</code>			
<code>Fast Round[inset=1cm]</code>	<code>Fast Round[inset=2cm]</code>	<code>Fast Triangle[inset=1cm]</code>	<code>Fast Triangle[inset=2cm]</code>

<code>inset=1cm 1</code>	<code>inset=1cm 2</code>	<code>inset=1cm 4</code>	<code>inset=1cm .2</code>

<code>inset=0cm 1</code>	<code>inset=0cm 2</code>	<code>inset=0cm 4</code>	<code>inset=0cm .2</code>

<code>inset=0cm .2</code>	<code>inset=0cm .2 2</code>	<code>inset=0cm .2 10</code>	<code>inset=0cm 2 .5</code>

inset=0cm .2	inset=0cm .2 2	inset=0cm .2 10	inset=0cm 2 .5

Paramètre angle [PGFmanual section : 16-3-1](#)

<code>\tikz \draw[-{Straight Barb[angle=60:.5cm 1]},line width=.2cm,blue] (0,0) -- (1,1);</code>				
[angle=60:.5cm 1]	[angle=60:.5cm 1]	[angle=60:.5cm 20]	[angle=60:.5cm 5]	[angle=90:.5cm 5]

<code>\tikz \draw[-{Triangle[angle=60:.5cm 1]},line width=.2cm,blue] (0,0) -- (1,1);</code>				
[angle=60:.5cm 1]	[angle=60:.5cm 1]	[angle=60:.5cm 20]	[angle=60:.5cm 5]	[angle=90:.5cm 5]

Paramètre scale [PGFmanual section : 16-3-2](#)





















<code>\tikz \draw[-{Arc Barb[scale=4]},line width=.1cm,blue] (0,0) -- (3,0);</code>		
scale=4	scale length=4	scale width=4

Paramètre arc [PGFmanual section : 16-3-3](#)







<code>\tikz \draw[-{Arc Barb[arc=270]},line width=.2cm,blue] (0,0) -- (3,1);</code>			
Arc Barb[arc=270]	Arc Barb[arc=360]	Hooks[arc=270]	Hooks[arc=360]

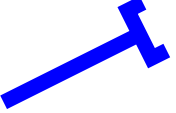

Paramètre slant [PGFmanual section : 16-3-4](#)

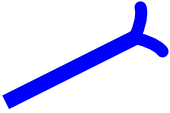
<code>\tikz \draw[-{Arc Barb[slant=.3]},line width=.2cm,blue] (0,0) -- (1,1);</code>				
slant=0	slant=0.3	slant=0.5	slant=0.8	slant=1

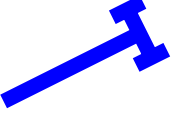
<code>\tikz \draw[-{Arc Barb[slant=.5]},line width=.2cm,blue] (0,0) - - (1,1);</code>				
				
Arc Barb	Bracket	Hooks	Parenthesis	Classical TikZ Rightarrow
				
Straight Barb	Tee Barb	Circle	Diamond	Ellipse
				
Kite	Latex	Rectangle	Square	Stealth
				
Turned Square	Fast Round	Fast Triangle	Round Cap	Triangle Cap

Paramètre reversed [PGFmanual section : 16-3-5](#)

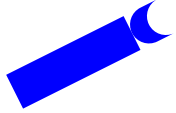
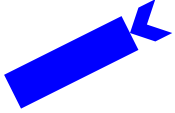
<code>\tikz \draw[-{Arc Barb[reversed]},line width=.2cm,blue] (0,0) - - (2,1);</code>			
			
Arc Barb	Bracket	Hooks	Classical TikZ Rightarrow
			
Straight Barb	Tee Barb	Parenthesis	Computer Modern Rightarrow

<code>\tikz \draw[-{Fast Round[reversed]},line width=.5cm,blue] (0,0) - - (2,1);</code>			
			
Fast Round	Fast Triangle	Round Cap	Triangle Cap

Paramètre left PGFmanual section : 16-3-5

<code>\tikz \draw[-{Arc Barb[left]},line width=.2cm,blue] (0,0) -- (1.5,1);</code>					
Arc Barb	Bracket	Hooks	Parenthesis	Classical TikZ Rightarrow	Triangle
Straight Barb	Tee Barb	Circle	Diamond	Ellipse	Turned Square
Kite	Latex	Rectangle	Square	Stealth	Rays

Paramètre right PGFmanual section : 16-3-5

<code>\tikz \draw[-{Arc Barb[right]},line width=.2cm,blue] (0,0) -- (1.5,1);</code>					
Arc Barb	Bracket	Hooks	Parenthesis	Classical TikZ Rightarrow	Triangle
Straight Barb	Tee Barb	Circle	Diamond	Ellipse	Turned Square
Kite	Latex	Rectangle	Square	Stealth	Rays









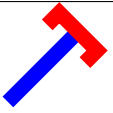
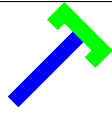
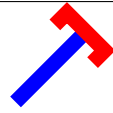



Paramètre harpoon PGFmanual section : 16-3-5

<code>\tikz \draw[-{Arc Barb[harpoon]},line width=.2cm,blue] (0,0) -- (1,1);</code>						
Arc Barb	Bracket	Hooks	Parenthesis	Classical TikZ Rightarrow	Straight Barb	Tee Barb





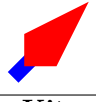
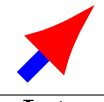
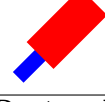
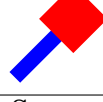

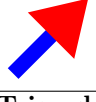
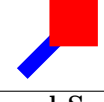
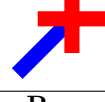

<code>\tikz \draw[-{Arc Barb[harpoon,swap]},line width=.2cm,blue] (0,0) -- (1,1);</code>						
Arc Barb	Bracket	Hooks	Parenthesis	Classical TikZ Rightarrow	Straight Barb	Tee Barb







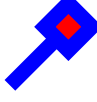



Paramètre color [PGFmanual section : 16-3-6](#)

<code>\tikz \draw[-{Arc Barb[<b>color=red</b>],line width=.2cm,blue} (0,0) -- (1,1);</code>		
		
<code>Bracket[<b>color=red</b>]</code>	<code>Bracket[<b>color=green</b>]</code>	<code>Bracket[<b>red</b>]</code>

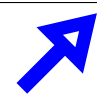





<code>\tikz \draw[-{Arc Barb[<b>red</b>],line width=.2cm,blue} (0,0) -- (1,1);</code>				
				
Arc Barb	Bracket	Hooks	Parenthesis	Classical TikZ Rightarrow
				
Straight Barb	Tee Barb	Circle	Diamond	Ellipse
				
Kite	Latex	Rectangle	Square	Stealth
				
Triangle	Turned Square	Rays		

Paramètre fill [PGFmanual section : 16-3-6](#)



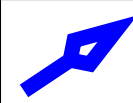

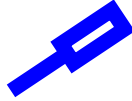
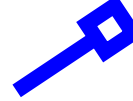











<code>\tikz \draw[-{Circle[<b>fill=red</b>],line width=.2cm,blue} (0,0) -- (1,1);</code>				
				
Circle	Diamond	Ellipse	Kite	Triangle
				
Latex	Rectangle	Square	Stealth	Turned Square

















<code>\tikz \draw[-{Circle[<b>fill=none</b>],line width=.2cm,blue} (0,0) -- (1,1);</code>				
				
Circle	Diamond	Ellipse	Kite	Triangle
				
Latex	Rectangle	Square	Stealth	Turned Square

Paramètre open PGFmanual section : 16-3-6

















<code>\tikz \draw[-{Circle[open]},line width=.2cm,blue] (0,0) - - (1.5,1);</code>				
				
Circle	Diamond	Ellipse	Kite	Triangle
				
Latex	Rectangle	Square	Stealth	Turned Square

















Paramètre line cap : round or butt PGFmanual section : 16-3-7

<code>\tikz \draw[-{Arc Barb[line cap=butt ]},line width=.2cm,blue] (0,0) - - (1,1);</code>							
							
Arc Barb	Bracket	Hooks	Parenthesis	Ellipse	Rectangle	Square	Stealth
							
Straight Barb	Tee Barb	Diamond	Kite	Latex	Triangle	Turned Square	Rays

















<code>\tikz \draw[-{Arc Barb[line cap=round ]},line width=.2cm,blue] (0,0) - - (1,1);</code>							
							
Arc Barb	Bracket	Hooks	Parenthesis	Ellipse	Rectangle	Square	Stealth
							
Straight Barb	Tee Barb	Diamond	Kite	Latex	Triangle	Turned Square	Rays

Paramètre line join : round or miter PGFmanual section : 16-3-7





<code>\tikz \draw[-{Arc Barb[line join=miter ]},line width=.2cm,blue] (0,0) - - (1,1);</code>							
							
Arc Barb	Bracket	Hooks	Parenthesis	Ellipse	Rectangle	Square	Stealth
							
Straight Barb	Tee Barb	Diamond	Kite	Latex	Triangle	Turned Square	Rays

<code>\tikz \draw[-{Arc Barb[line cap=round ]},line width=.2cm,blue] (0,0) - - (1,1);</code>							
							
Arc Barb	Bracket	Hooks	Parenthesis	Ellipse	Rectangle	Square	Stealth
							
Straight Barb	Tee Barb	Diamond	Kite	Latex	Triangle	Turned Square	Rays

Paramètre round [PGFmanual section : 16-3-7](#)

<code>\tikz \draw[-{Arc Barb[round ]},line width=.2cm,blue] (0,0) - - (1,1);</code>							
							
Arc Barb	Bracket	Hooks	Parenthesis	Ellipse	Rectangle	Square	Stealth
							
Straight Barb	Tee Barb	Diamond	Kite	Latex	Triangle	Turned Square	Rays

Paramètre sharp [PGFmanual section : 16-3-7](#)

<code>\tikz \draw[-{Classical TikZ Rightarrow[sharp ]},line width=.2cm,blue] (0,0) - - (2,0);</code>			
<code>-{Classical TikZ Rightarrow[sharp]}</code>	<code>-{Computer Modern Rightarrow[sharp]}</code>	<code>-{Classical TikZ Rightarrow[sharp]}</code>	<code>-{Computer Modern Rightarrow[sharp]}</code>
			
sharp	[ ]	sharp	[ ]

Paramètre line width PGFmanual section : 16-3-7

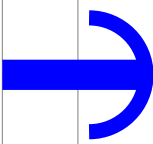
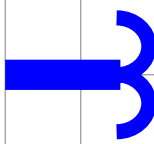
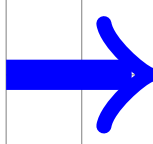
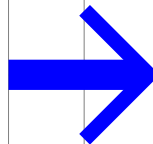
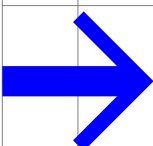
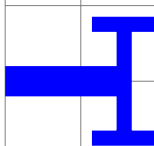
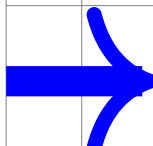
<code>\tikz \draw[-{Arc Barb[line width=.2cm]},line width=.4cm,blue] (0,0) -- (2,0);</code>			
			
Arc Barb	Hooks	Classical TikZ Rightarrow	Straight Barb
			
Straight Barb	Tee Bar	Computer Modern Rightarrow	

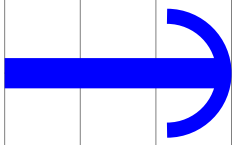
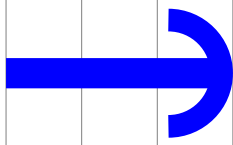
<code>\tikz \draw[-{Arc Barb[length=0cm 10]},line width=.1cm,blue] (0,0) -- (3,1);</code>	
	
[length=0cm 10]	[length=.5cm 5]
$0\text{cm} + 10 \times .1\text{cm} = 1\text{cm}$	$.5\text{cm} + 5 \times .1\text{cm} = 1\text{cm}$

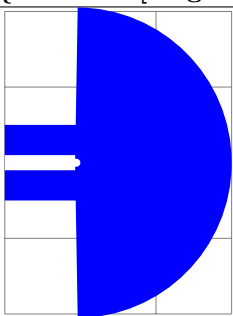
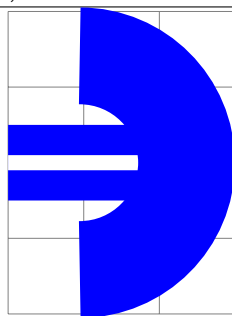
<code>\tikz \draw[-{Arc Barb[length=0cm 5]},line width=.1cm,blue,double,double distance = 2 mm] (0,0) -- (3,1)</code>	
	
[length=0cm 5]	[length=0cm 5 .6]
$0\text{cm} + 5 \times (.1\text{cm} + 2\text{ mm} + .1\text{cm}) = 2\text{cm}$	$0\text{cm} + 5 \times (.6 \times .1\text{cm} + (1-.6)(.1\text{cm} + 2\text{ mm} + .1\text{cm})) = 11\text{ mm}$



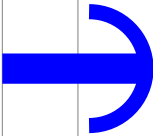
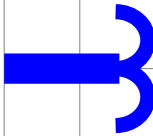
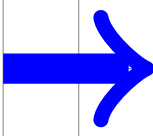
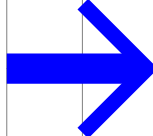
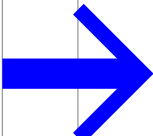
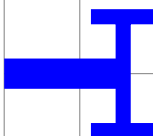
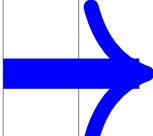

Paramètre line width' PGFmanual section : 16-3-7

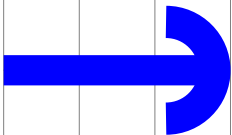
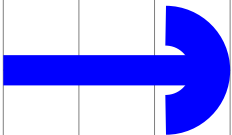
<code>\tikz \draw[-{Arc Barb[line width'=.2cm]},line width=.4cm,blue] (0,0) - - (1,1);</code>			
			
Arc Barb	Hooks	Classical TikZ Rightarrow	Straight Barb
			
Straight Barb	Tee Bar	Computer Modern Rightarrow	

<code>\tikz \draw[-{Arc Barb[line width=0cm 10]},line width'=.1cm,blue] (0,0) - - (3,1);</code>	
	
[length=0cm 10]	[length=.5cm 5]
$0\text{cm} + 10 \times .1\text{cm} = 1\text{cm}$	$.5\text{cm} + 5 \times .1\text{cm} = 1\text{cm}$

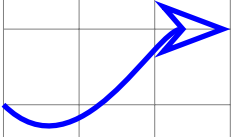
Paramètre quick PGFmanual section : 16-3-8

<code>\tikz \draw[-{Stealth[length=1cm,open,quick]}] (0,0) .. controls (1,-1) and (2,1) .. (3,1);</code>	
	
[-Stealth[length=1cm,open,quick]]	[-Stealth[length=1cm,open]]

Paramètre bending PGFmanual section : 16-3-8

Charger l'extension : `\usetikzlibrary{bending}`

`\tikz \draw[-{Stealth[length=1cm,open,flex=0]}] (0,0) .. controls (1,-1) and (2,1) .. (3,1);`

flex=0	flex=0.5	flex=1

`\tikz \draw[-{Stealth[length=1cm,open,flex'=0]}] (0,0) .. controls (1,-1) and (2,1) .. (3,1);`

flex'=0	flex'=0.5	flex'=1

`\tikz \draw[-{Stealth[length=1cm,open,bend]}] (0,0) .. controls (1,-1) and (2,1) .. (3,1);`

<code>[-{Stealth[length=1cm,open,bend]}]</code>	<code>[-Stealth[length=1cm,open,bend]Stealth[length=1cm,open,bend,sep]]</code>

Paramètre cap angle PGFmanual section : 16-5-4

`\tikz \draw[-{Fast Round[cap angle=60]},line width=.2cm,blue] (0,0) - - (3,1);`

Fast Round[cap angle=20]	Fast Round[cap angle=60]	Fast Round[cap angle=90]
Fast Triangle[cap angle=20]	Fast Triangle[cap angle=60]	Fast Triangle[cap angle=90]

## 5 Insertion de petites images

### 5.1 Images créées



PGFmanual section : 14-19

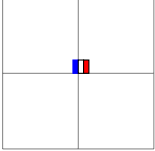
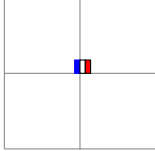
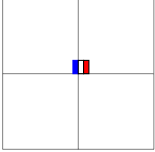
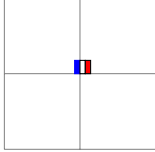
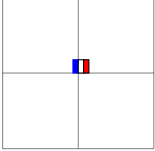
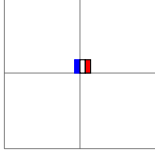

PGFmanual section : 18

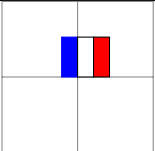
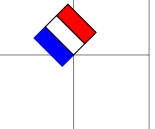
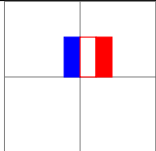

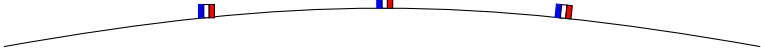

Création	Utilisation
<pre>\tikzset{dfr/.pic={\filldraw[blue] (-2pt,0) rectangle (0,5pt); \filldraw[fill=white] (0,0) rectangle (2pt,5pt); \filldraw[fill=red] (2pt,0) rectangle (4pt,5pt);}}</pre>	<pre>\tikz \pic {dfr};</pre> 

placement à une position	
	
<code>\pic at (1,1) [pic type = dfr];</code>	<code>\pic at (1,1) {dfr};</code>
	
<code>\path (1,1) pic [pic type= dfr];</code>	<code>\path (1,1) pic {dfr};</code>
	
<code>\pic [at={(1,1)}] [pic type= dfr];</code>	<code>\pic [at={(1,1)}] {dfr};</code>

<code>\pic[scale=3] at (1,1) {dfr};</code>		
		
<code>[scale=3]</code>	<code>[scale=3,rotate=45]</code>	<code>[scale=3,red]</code>

<pre>\tikz [scale=4] \pic at (0,0) {dfr}; \pic at (.5,0) [transform shape] {dfr};</pre>	 
---	---

Placement sur un chemin
<pre>\tikz \draw (0,0) to [out=10,in=170] pic [near start] {dfr} pic {dfr} pic [sloped, near end] {dfr} (10,0);</pre>

<pre>\draw (0,0) to [out=10,in=170] pic [pos=.3] {code={\draw circle [radius=3mm];}} (10,0);</pre>

Définition :				
<pre>\tikzset{ my pic/.pic = { \path [pic actions] (0,0) circle[radius=3mm]; \draw (-3mm,-3mm) rectangle (3mm,3mm); } }</pre>				
Utilisation :				
<pre>\pic [red] {my pic}</pre>				
				
[red]	[draw]	[draw=red]	[draw, shading=ball]	[fill=red !50]

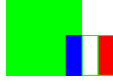
<pre>\tikz \pic foreach \x in {1,1.5,...,10} at (\x,0) {dfr};</pre>

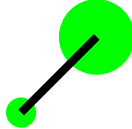
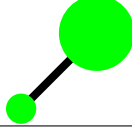
<pre>\fill [green] (0,0) - - (1,0)pic [behind path,scale=3] {dfr} - (1,1) - (0,1) - cycle;</pre>	
	
[behind path,scale=3]	[scale=3]

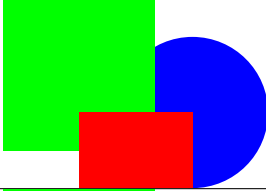
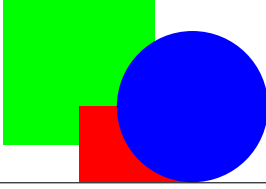
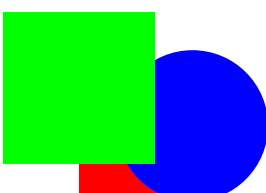
<pre>\tikzset{ pics/mon cercle/.style = { background code = { \fill circle [radius=#1] ; } } } \tikz [fill=green] \draw[line width=3pt] (0,0) pic {mon cercle=2mm} - - (1,1) pic {mon cercle=5mm};</pre>	
<pre>\tikzset{ pics/mon cercle/.style = { foreground code = { \fill circle [radius=#1] ; } } } \tikz [fill=green] \draw[line width=3pt] (0,0) pic {mon cercle=2mm} - - (1,1) pic {mon cercle=5mm};</pre>	

<pre>\fill [green](-1,0) - - (1,0) pic [pics/background code={\fill[blue] (0.5,0.5) circle (1cm) }; , pics/code=\fill[red] (-1,-.5) rectangle (0.5,0.5); ] {} - - (1,2) - - (-1,2) - - cycle;</pre>	
<pre>\fill [green] (-1,0) - - (1,0) pic [pics/foreground code=\fill[blue] (0.5,0.5) circle (1cm) ); ,pics/code={\fill[red] (-1,-.5) rectangle (0.5,0.5); } ] {} - - (1,2) - - (-1,2) - - cycle;</pre>	
<pre>\fill [green](-1,0) - - (1,0) pic [pics/background code={\fill[blue] (0.5 , 0.5) circle (1cm )};] ,pics/code={\fill[red] (-1 , -0.5) rectangle (0.5 , 0.5)};},behind path ] {} - - (1,2) - - (-1,2) - - cycle;</pre>	
<pre>\fill [green] (-1,0) - - (1,0) pic [pics/foreground code={\fill[blue] (0.5 , 0.5) circle (1cm) };] , pics/code={\fill[red] (-1,-.5) rectangle (0.5 , 0.5)};},behind path ] {} - - (1,2) - - (-1,2) - - cycle;</pre>	

## 5.2 Images prédéfinies : Marquage des angles

PGFmanual section : 39

Charger l'extension : `\usetikzlibrary{angles}`

```
\tikz \draw (2,0) coordinate (A) -- (0,0) coordinate (B)
-- (1,1) coordinate (C) pic [draw] {angle};
```

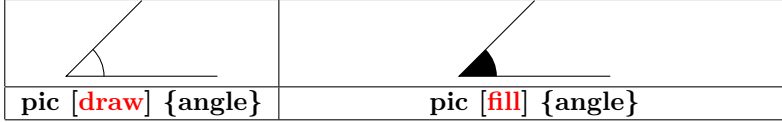

```
\tikz \draw (2,0) coordinate (X) -- (0,0) coordinate (Y)
-- (1,1) coordinate (Z) pic [draw] {angle= X- -Y- -Z};
```

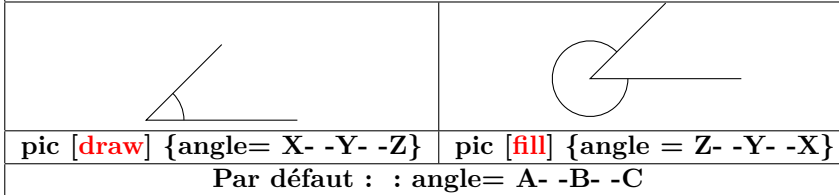

```
\tikz \draw (2,0) coordinate (A) -- (0,0) coordinate (B)
-- (1,1) coordinate (C) pic [draw,->] {angle};
```



```
\tikz \draw (2,0) coordinate (A) -- (0,0) coordinate (B)
-- (1,1) coordinate (C) pic [draw,angle radius=1cm] {angle};
```

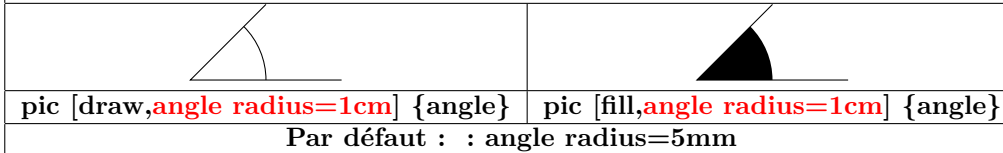

Charger l'extension : `\usetikzlibrary{quotes}`

```
\tikz \draw (3,0) coordinate (A) -- (0,1) coordinate (B) -- (1,2) coordinate (C)
pic [draw,"$\alpha$ " ] {angle};
```

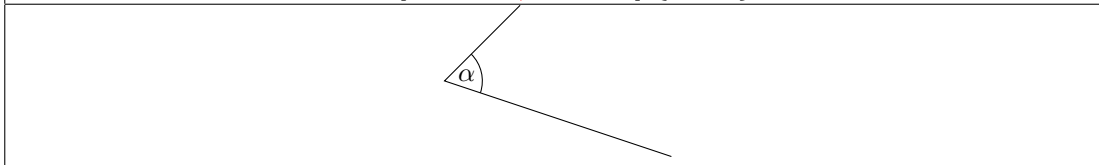

```
\tikz \draw (2,0) coordinate (A)
-- (0,0) coordinate (B) -- (1,2) coordinate (C)
pic [draw, " $\alpha$", angle eccentricity=1] {angle};
```

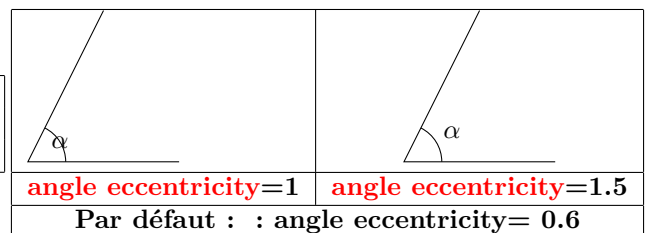

```
\tikz { \draw (2,0) coordinate (A) - - (0,0) coordinate (B) - - (1,2) coordinate (C)
pic (xxx) [draw,"$\alpha$",angle radius= 1cm ] {angle};
\draw (xxx)circle [radius=5pt]; }
```

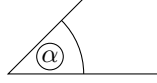

## 6 Les coordonnées

### 6.1 Quadrillage

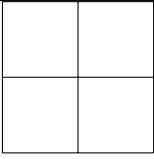
<code>\draw (0,0) grid (2,2);</code> <small>PGFmanual section : 14-8</small>

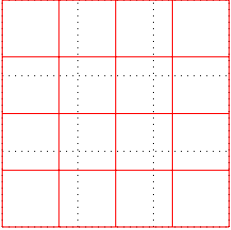
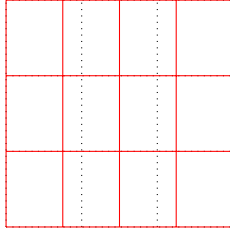
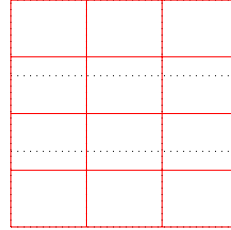
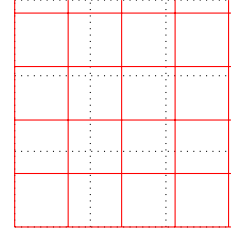
<code>\draw (0,0) grid [step=.75cm] (0,0) grid (3,3);</code>			
			
<code>step=.75cm</code>	<code>x step=.75cm</code>	<code>y step=.75cm</code>	<code>step=(45:1)</code>

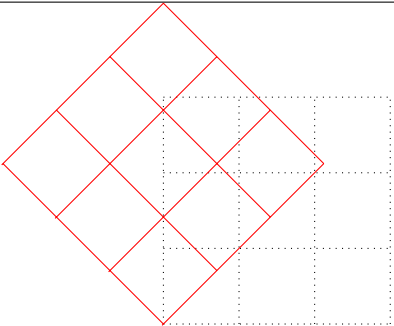
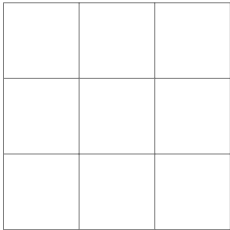
<code>\draw[red] (0,0) grid [rotate=45] (3,3);</code>	<code>\draw[help lines] (0,0) grid (3,3);</code>
	

## 6.2 Coordonnées

PGFmanual section : 13-2-1

### 6.2.1 Système de coordonnées « canvas »

Explicite	Implicite
<code>\fill (canvas cs :x=2cm,y=1.5cm) circle (2pt);</code>	<code>\fill (2cm,1.5cm) circle (2pt);</code>

### 6.2.2 Système de coordonnées polaire « canvas »

Explicite	Implicite
<code>\fill (canvas polar cs :angle=45,radius=2cm) circle (2pt);</code>	<code>\fill (45:2cm) circle (2pt);</code>

<code>\fill (canvas polar cs:angle=45,x radius=3cm,y radius=2cm) circle (2pt);</code>

### 6.2.3 Système de coordonnées xyz

<code>\draw (0,0) - - (xyz cs:x=1);</code> <code>\draw[red] (0,0) - - (xyz cs:y=1);</code> <code>\draw[magenta] (0,0) - - (xyz cs:z=1);</code>	<code>\draw (0,0) - - (1,0,0);</code> <code>\draw[red] (0,0) - - (0,1,0);</code> <code>\draw[magenta] (0,0) - - (0,0,1);</code>



### 6.2.4 Coordinate system xyz polar

Explicite		Implicite	
<code>\fill (xyz polar cs :angle=45,radius=2) circle (2pt);</code>		<code>\fill (45:2cm) circle (2pt);</code>	
<code>\fill (xyz polar cs:angle=45,x radius=3,y radius=2) circle (2pt);</code>			
<code>\begin{tikzpicture}[x=1.5cm,y=1cm]</code>			
<code>\fill (xyz polar cs :angle=45,radius=2) circle (2pt);</code>		<code>\fill (45:2cm) circle (2pt);</code>	
<code>\begin{tikzpicture}[x={(0cm,1cm)},y={(-1cm,0cm)}]</code>			
<code>\fill (xyz polar cs :angle=45,radius=2) circle (2pt);</code>		<code>\fill (45:2cm) circle (2pt);</code>	

### 6.2.5 Coordonnées barycentriques

[PGFmanual section : 13-2-2](#)

<code>\node [circle,fill=red!20] at (barycentric cs:A=0.6,B=0.3) {X};</code>			
A=0.3,B=0.3	A=0.4,B=0.4,C=.4	A=0.5,B=0.5,C=.5,D=.5	
A=0.6,B=0.3	A=0.2,B=0.4,C=.6	A=0.2,B=0.4,C=.6,D=.8	

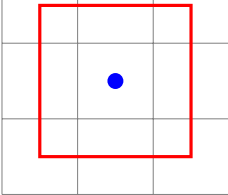

### 6.2.6 Coordonnées nominatives : noeud

PGFmanual section : 13-2-3

	<pre>\coordinate (centre) at(1.5,1.5); \coordinate (A) at (.5,.5); \coordinate (B) at (2.5,2.5);  \fill (centre) circle (3pt); \draw[red] (A) rectangle (B);</pre>
---	--

voir aussi page 49

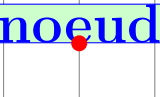
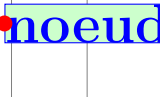
### 6.2.7 Coordonnées relatives à un noeud

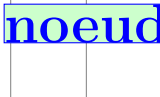
<pre>\node [draw,fill=green!20,] (A) at (1,1) {\huge noeud}; \fill[red] (node cs :name=A,anchor=south) circle (3pt);</pre>			
			
name=A,anchor=south	name=A,anchor=west	name=A,anchor=north	name=A,anchor=east

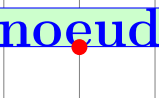
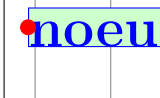
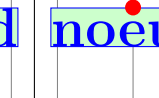
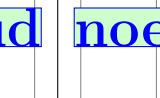
<pre>\node [draw,fill=green!20,] (A) at (1,1) {\huge noeud}; \fill[red] (A.south) circle (3pt);</pre>			
			
A.south	A.west	A.north	A.east

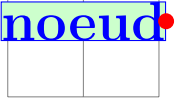
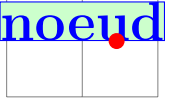
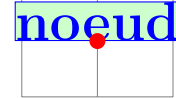
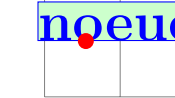
<pre>\fill[red] (node cs :name=A,angle=0) circle (3pt);</pre>			
			
name=A,angle=0	name=A,angle=-30	name=A,angle=-90	name=A,angle=-150

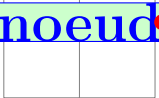
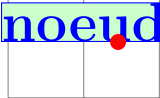
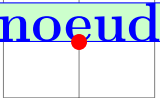
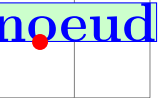
<pre>\fill[red] (A.0) circle (3pt);</pre>			
			
A.0	A.-30	A.-90	A.-150

voir aussi page 105

### 6.2.8 Coordonnées relatives à deux points

PGFmanual section : 13-3-1

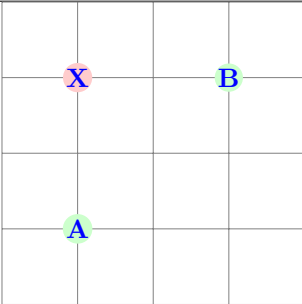
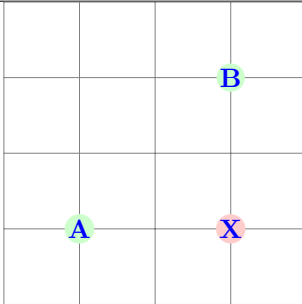
<code>\node [circle,fill=red!20] at (1,1  - 3,3) {X}</code>	
	
at (1,1  - 3,3)	at (1,1   3,3)

### 6.2.9 Coordonnée relative à une intersection

PGFmanual section : 13-3-2

Charger l'extension : `\usetikzlibrary{intersections}`

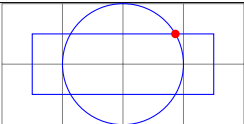
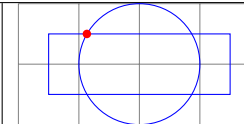
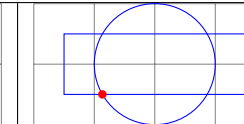
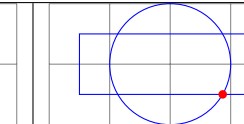
<code>\draw [name path=XXX] (2,1) circle (1cm);</code> <code>\draw [name path=YYY] (0.5,0.5) rectangle +(3,1);</code> <code>\fill [red,name intersections={of=xxx and YYY}] (intersection-1) circle (2pt)</code>			
			
intersection-1	intersection-2	intersection-3	intersection-4

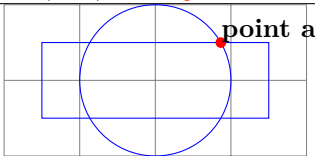
<code>\fill [red, name intersections={of=XXX and YYY}]</code> <code>(intersection-1) circle (2pt) <b>node[black,above right] {point a};</b></code>

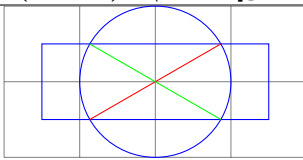
<code>\fill [red, name intersections={of=XXX and YYY, name=ZZZ}];</code> <code>\draw [red] (ZZZ-1) - - (ZZZ-3); \draw [green] (ZZZ-2) - - (ZZZ-4);</code>

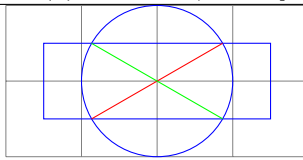
<code>\fill [red, name intersections={of=XXX and YYY, by={a,b,c,d}}];</code> <code>\draw [red] (a) - - (c); \draw [green] (b) - - (d);</code>

```

\fill [name intersections={of=XXX and YYY, name=i, total=\t}] [red]
\foreach \s in {1,...,\t} {(i-\s) circle (2pt) node[black,above right] {\s}}

```

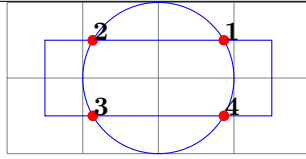

### 6.2.10 Position calculée avec le module « pgfmath »

PGFmanual section : 13-2-1

Ce module est chargé automatiquement avec le module Tikz

<p><i>Explicite</i> : <code>\fill [red] (canvas cs:x=2cm+1.5cm,y=1.5cm-1cm) circle (3pt) ;</code></p> <p><i>Implicite</i> : <code>\fill [red] (2cm+1.5cm,1.5cm-1cm) circle (3pt) ;</code></p>

	<pre> \draw[dashed] (2,2) circle (2); \fill [red](2+ 2*cos 30 , 2+2*sin 30) circle (3pt); \fill[magenta]      (2+2*cos{(120)}      , 2+2*sin{(120)}) circle (3pt); </pre>
--	---

### 6.2.11 Position calculée avec « library calc »

PGFmanual section : 13-5

Charger l'extension : `\usetikzlibrary{calc}`

	<pre> \node (a) at (1,1) {A}; \fill [red] (\$(a) + 2/3*(1cm,0)\$) circle (2pt); \fill [red] (\$(a) + 4/3*(1cm,0)\$) circle (2pt); </pre>
--	--

### 6.2.12 Tangentes avec « library calc »

PGFmanual section : 13-2-4

<pre> \node[fill=green!20] (a) at (3,1.5) {A}; \fill[red] (tangent cs :node=c,point={A},solution=1); </pre>	
<b>solution=1</b>	<b>solution=2</b>

### 6.2.13 Point à pourcentage donné

PGFmanual section : 13-5-3

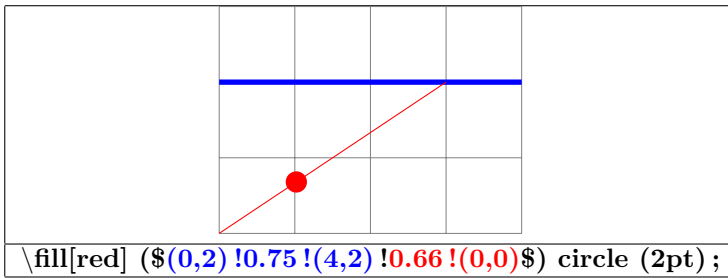
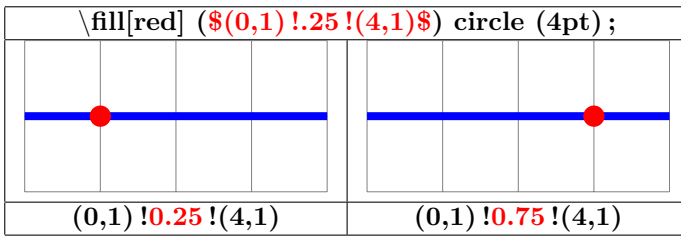

### 6.2.14 Point à distance donnée

PGFmanual section : 13-5-4

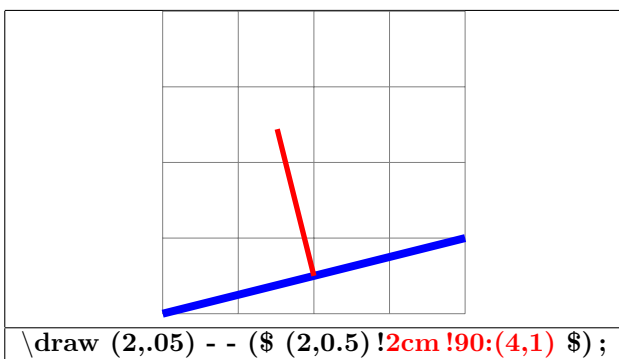
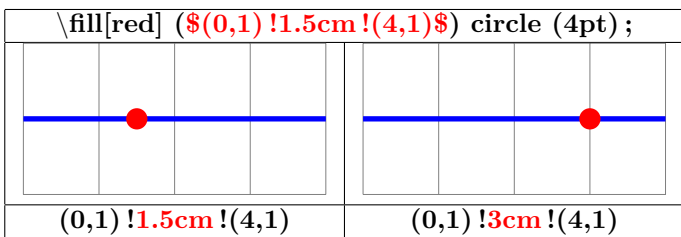

### 6.2.15 Coordonnées relatives

#### Cartésienne

[PGFmanual section : 13-4-1](#)

relative à l'origine	relative à une position	relative à la dernière position
<code>(0,0) -- (1,0)</code> <code>-- (2,1) -- (2,-1)</code>	<code>(0,0) -- (1,0)</code> <code>-- +(2,1) -- +(2,-1)</code>	<code>(0,0) -- (1,0)</code> <code>-- ++(2,1) -- ++(2,-1)</code>

<code>\draw (0,0) rectangle (1,1)</code> <code>rectangle (2,2) rectangle (3,3);</code>	<code>\draw (0,0) rectangle (1,1)</code> <code>rectangle +(2,2) rectangle +(3,3);</code>	<code>\draw (0,0) rectangle (1,1)</code> <code>rectangle ++(2,2) rectangle ++(3,3);</code>

#### Polaire

relative à l'origine	relative à une position	relative à la dernière position
<code>(0:0) -- (0:1)</code> <code>-- (30:2) -- (-30:2)</code>	<code>(0:0) -- (0:1)</code> <code>-- +(30:2) -- +(-30:2)</code>	<code>(0:0) -- (0:1)</code> <code>-- ++(30:2) -- ++(-30:2)</code>

#### coordonnée relative en polaire

[PGFmanual section : 13-4-2](#)

<code>\draw[blue,very thick] (0,0) -- (2,1) -- ([turn]-45:1cm);</code>	
<code>([turn]-45:1cm)</code>	<code>([turn]45:1cm)</code>

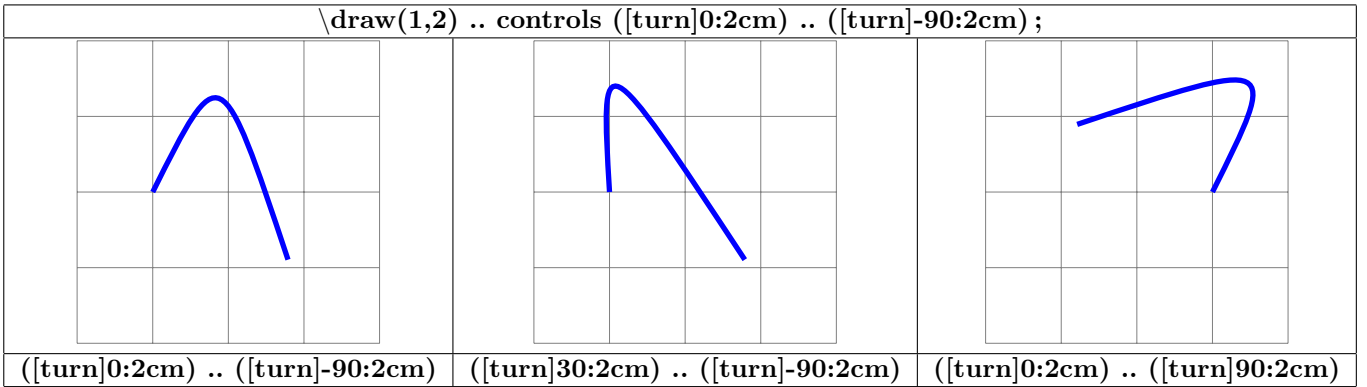
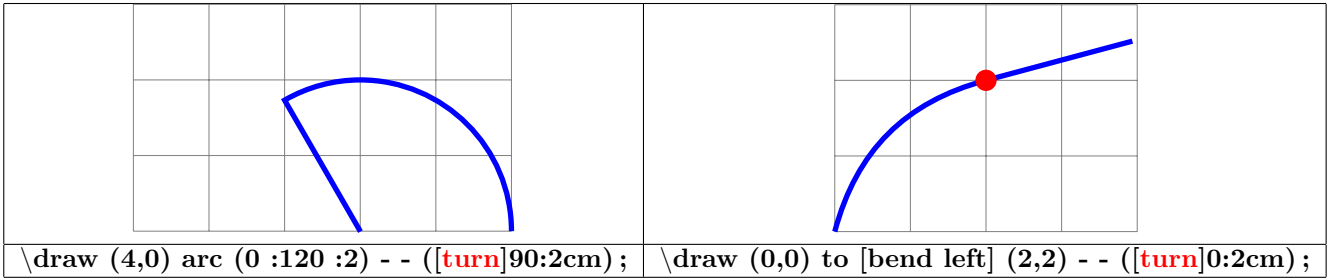



## 7 Les nœuds

### 7.1 Définition des nœuds

<code>\draw (1,1) node[fill=red!20] {};</code>				
Par défaut :	<code>node[draw]</code>	<code>node[<b>circle</b>]</code>	<code>node[<b>circle,draw</b>]</code>	<code>node[<b>coordinate</b>]</code>

<code>\node at (1,1) [fill=red!20] {};</code>			
<code>[fill=red!20]</code>	<code>[draw]</code>	<code>[<b>circle</b>,fill=red!20]</code>	<code>[<b>circle</b>,draw]</code>

Autres types de nœuds voir page 90

<code>\draw (0,0) node at (1,0) {1} node at (2,0) {2} node at (3,0) {3} node at (4,0) {4} node at (5,0) {5};</code>	<code>\draw(0,0) node foreach \x in {1,2,...,5} at (\x,0) {\x};</code>
1   2   3   4   5	1   2   3   4   5

<code>\draw[<b>every node/.style={draw,red}</b>](0,0) node foreach \x in {1,2,...,5} at (\x,0) {\x};</code>

<code>\draw[<b>every rectangle node/.style={draw,red}</b>, <b>every circle node/.style={draw,double}</b>](0,0) node at (1,0) {1} node[<b>circle</b>] at (2,0) {2} node[<b>circle</b>] at (3,0) {3} node at (4,0) {4} node at (5,0) {5};</code>

### 7.2 Nom des nœuds

<code>\node[<b>name=A</b>] at (0,0) {} \draw (A) circle (.5);</code>	<code>\node[<b>name=A,alias=B</b>] at (0,0) {} \draw (B) circle (.5);</code>	<code>\node(<b>C</b>) at (0,0) {} \draw (C) circle (.5);</code>

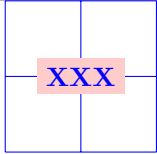
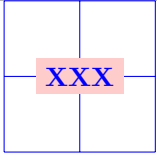

### 7.3 Contenu des nœuds

PGFmanual section : 17-2-1

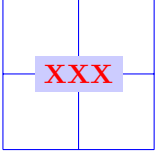
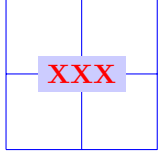
<code>\node at (1,1) [fill=red!20]{XXX} ;</code>	<code>\node at (1,1) [fill=red!20,node contents=XXX] {} ;</code>
	

<code>\node[red] at (1,1) [fill=blue!20] {XXX} ;</code>	<code>\node[red] at (1,1) [fill=blue!20,node contents=XXX] {} ;</code>
	

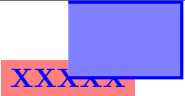
### 7.4 Premier ou arrière plan

<code>\tikz \fill [fill=blue!50, draw=blue, very thick] (0,0)</code> <code>node [behind path, fill=red!50] {XXXXX}</code> <code>-- (1.5,0) -- (1.5,1) -- (0,1) ;</code>	
	
<b>behind path</b>	<b>in front of path</b>

### 7.5 Noms à préfixe ou suffixe

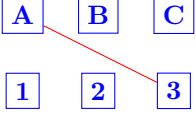
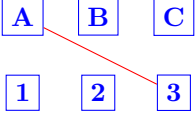
	<code>\draw[name prefix = top-] node (A) at (1,1) {A} node (B) at (2,1)</code> <code>{B} node (C) at (3,1) {C} ;</code> <code>\draw[name prefix = bottom-] node (1) at (1,0) {1} node (2) at (2,0)</code> <code>{2} node(3) at (3,0) {3} ;</code> <code>\draw [red] (top-A) - (bottom-3) ;</code>
	<code>\draw[name suffix = -top] node (A) at (1,1) {A} node (B) at (2,1)</code> <code>{B} node (C) at (3,1) {C} ;</code> <code>\draw[name suffix = -bottom] node (1) at (1,0) {1} node (2) at (2,0)</code> <code>{2} node(3) at (3,0) {3} ;</code> <code>\draw [red] (A -top) - - (3 -bottom) ;</code>

## 7.6 Liaisons

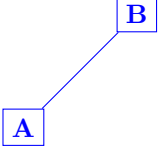
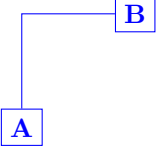
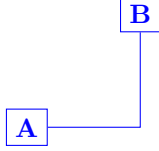
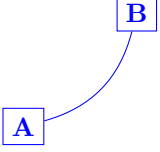
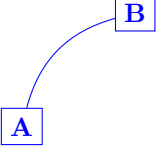
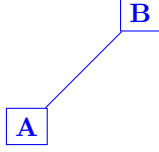
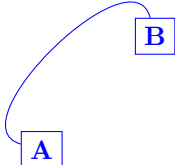
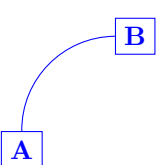
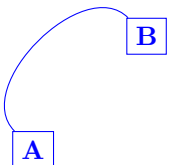
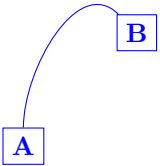
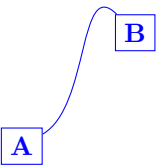
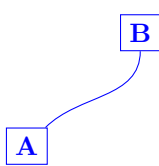
<code>\node[draw] (A) at (0,0) {A}; \node[draw] (B) at (1.5,1.5) {B}; \draw (A) - - (B)</code>		
		
(A) - - (B)	(A)  - (B)	(A) -  (B)
		
(A) to [bend right] (B)	(A) to [bend left] (B)	(A) to [bend left=0] (B)
		
(A) to [bend left=120] (B)	(A) to [bend left=45] (B)	(A) to [bend left=90] (B)
		
(A) to [out=90] (B)	(A) to [out=30] (B)	(A) to [in=-90] (B)

<code>\draw (A) .. controls +(right:2cm) and +(down:2cm) .. (B);</code>	
<code>controls +(right:2cm) and +(down:2cm)</code>	<code>controls +(up:1cm) and +(left:1cm)</code>
<code>controls +(right:1cm) and +(right:2cm)</code>	<code>controls +(up:1cm) and +(right:2cm)</code>
<code>controls +(120:2cm) and +(200:1cm)</code>	<code>controls +(120:2cm) and +(200:1cm)</code>
<code>controls +(C) and +(D)</code>	<code>controls +(D)</code>

<code>\node[draw] (A) at (0,0) {A}</code> <code>\node[draw] (B) at (2,2) {B} <b>edge</b> [-&gt;] (A);</code> <a href="#">PGFmanual section : 17-12-1</a>		
<code>[-&gt;]</code>	<code>[red]</code>	<code>[dashed]</code>

## 7.7 Étiquettes sur les nœuds

\fill(0,0) circle (2pt) node[above] {texte}; <a href="#">PGFmanual section : 17-5-2</a>			
[above]	[below]	[left]	[right]
[above left]	[below left]	[above right]	[below right]
[anchor=south]	[anchor=west]	[anchor=north]	[anchor=east]
[anchor=south east]	[anchor=south west]	[anchor=north west]	[anchor=north east]

\fill(0,0) circle (2pt) node[above=.3cm] {texte}; <a href="#">PGFmanual section : 17-5-2</a>			
[above=.3cm]	[below=.3cm]	[left=.3cm]	[right=.3cm]
[above left=.3cm]	[below left=.3cm]	[above right=.3cm]	[below right=.3cm]

<code>\shorthandoff{:}</code> <sup>1</sup>				
<code>\node [draw,label=right:texte] {}</code>				
<code>\shorthandon{:}</code>				
label=right	label=left	label=above	label=below	label=45

<code>\fill(0,0) circle (2pt) node[below right=.3cm,draw,label=45:étiquette] {texte};</code>

### 7.8 Étiquettes épinglées

[PGFmanual section : 17-10-3](#)

<code>\shorthandoff{:}</code> <code>\node[circle,draw,blue,pin=texte] {};</code> <code>\shorthandon{:}</code> <sup>1</sup>		
[circle,pin=texte]	[circle,pin=60:texte]	[circle,pin=right:texte]

<code>\tikz[pin position=60] \node [circle,pin=texte] {};</code>		
[pin position=60]	[pin distance=0 cm]	[pin distance=2 cm]
Par défaut : : above	Par défaut : : 3 ex	

<sup>1</sup>désactivation et ré-activation de « : » conflit entre les modules Tikz et Babel en français

## 7.9 Nœuds sur un chemin

PGFmanual section : 17-8

<code>\draw(0,0) .. controls (1,2) and (2,-1) .. (4,0) node[at end] {texte} ;</code>		
<b>pos=0</b>	<b>pos=.33</b>	<b>at end (pos=1)</b>
<b>very near end (pos=0.875.)</b>	<b>near end (pos=0.75)</b>	<b>midway (pos=0.5)</b>
<b>near start (pos=0.25)</b>	<b>very near start (pos=0.125)</b>	<b>at start (pos=0)</b>

<code>\draw(0,0) .. controls (1,2) and (2,1) .. (4,0) node[sloped,midway] {texte} ;</code>		
<b>sloped</b>	<b>above</b>	<b>below</b>

<code>\draw(0,0) .. controls (1,2) and (2,1) .. (5,0) node[sloped,midway,allow upside down] {texte} ;</code>		
<b>sloped</b>	<b>above</b>	<b>below</b>

<code>\draw(A) to [bend right] node [bend right] {texte} (B);</code>		
<code>[bend right]</code>	<code>[auto,bend right]</code>	<code>[auto,swap,bend right]</code>

### 7.10 Nœuds sur un "edge"

<code>\draw(0,0) edge ["abc", -&gt;] (4,0);</code> <a href="#">PGFmanual section : 17-12-2</a>		
<code>["abc", -&gt;]</code>	<code>["abc", near start]</code>	<code>["abc", style={auto=right}]</code>
<code>[font=\Large,"abc"]</code>	<code>["abc" color=red]</code>	<code>["abc" ' ]</code>
<code>["abc" draw]</code>	<code>["abc" inner sep=0pt]</code>	<code>["abc" fill ,fill=yellow]</code>

<code>\draw[every edge quotes/.style={fill=yellow}] (0,0) edge ["abc"] (4,0);</code>

### 7.11 Positionnement relatif de nœuds

Charger l'extension: `\usetikzlibrary{positioning}`

[PGFmanual section : 17-5-3](#)

<code>\node (a) at (1,0) [above=.4cm+.6cm,draw] {XXX};</code>		
<code>above = 0.4cm+0.6cm</code>	<code>above = .5+sin(60)</code>	<code>above = 1</code>



<code>\node (a) at (1,0) [above right=3cm and 2cm,draw] {XXX};</code>	
above right=3cm and 2cm	below right=3cm and 2cm

	<pre>\node (a) at (1,1) {node a}; \node (b) [above=2cm of a.north east] {XXX};</pre>
--	--

<pre>\node (a) at (1,0) {node a}; \node (b) [above=1cm of a] {node b}; \node (c) [above=1cm of b] {node c};</pre>	<pre>\node (a) at (1,0) {node a}; \node (b) [on grid,above=1cm of a] {node b}; \node (c) [on grid,above=1cm of b] {node c};</pre>

	<pre>\begin{tikzpicture}[every node/.style=draw,node distance=1mm] \node (a1) at (1,0) {node a}; \node (b) [above=of a] {node b}; \node (c) [above=of b] {node c}; \end{tikzpicture}</pre>
--	--

<pre>\node[draw] (X) at (0,0) {X}; \node[draw] (a) [right=of X] {a}; \node[draw] (y) [right=of a] {y};</pre>	<pre>\node[draw] (X) at (0,0) {X}; \node[draw] (a) [base right=of X] {a}; \node[draw] (y) [base right=of a] {y};</pre>

## 7.12 Nœud enveloppant

Charger l'extension: `\usetikzlibrary{fit}`

PGFmanual section : 52

	<pre>\fill (.5,1) circle (3pt); \fill (2,.25) circle (3pt); \fill (1,2) circle (3pt); \fill (1.25,0.25) circle (3pt); \fill (1.75,1.5) circle (3pt); \node[draw=red,ultra thick,fit={(0.5,1) (2,.25) (1,2) (1.25,0.25) (1.75,1.5) }] {} ;</pre>
--	---

	<pre>[dot/.style={inner sep=0pt,draw,circle,blue}] \node[dot] (a) at (.5,1) {a}; \node[dot] (b) at (2,.25) {b}; \node[dot] (c) at (1,2) {c}; \node[dot] (d) at (1.25,0.25) {d}; \node[dot] (e) at (1.75,1.5) {e}; \node[draw=red,ultra thick,fit=(a) (b) (c) (d) (e)] {}</pre>
--	--

<pre>\node[draw=red,ultra thick,fit=(a) (b) (c) (d) (e)] (xxx) {} \node at (xxx.east) [fill=green!20] {x};</pre>		
xxx.east	xxx.north east	xxx.center

<pre>\node [draw=green,fit=(a) (b) (c) (d) (e)] ; \node [inner sep=0pt,draw=red,fit=(a) (b) (c) (d) (e)] ;</pre>	
inner sep=0pt	inner sep=.5cm

<pre>\node[circle,draw=red,inner sep=0pt,fit=(a) (b) (c) (d) (e)] {};</pre>		
circle	ellipse	shape=starburst (voir section 17 )

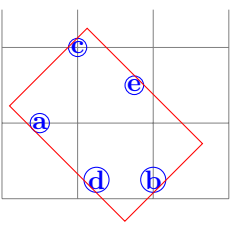
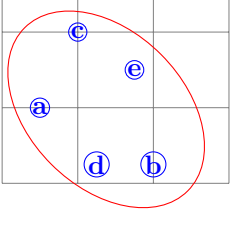
<code>\node[draw=red, rotate fit=45, fit=(a) (b) (c) (d) (e)] {};</code>	
	
<b>rotate fit=45</b>	<b>ellipse, rotate fit=45</b>

### 7.13 Cercle défini par deux points

Charger l'extension: `\usetikzlibrary{through}`

PGFmanual section : 71

```
\node [draw] at (2,1) [circle through={(1,2)}] {c};
```

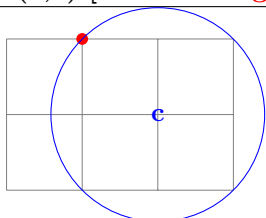

## 7.14 Matrice de nœuds

PGFmanual section : 20

	<pre>\node [matrix,fill=red!10,draw=blue,very thick] at (2,1) { \draw (0,0) circle (4mm); &amp; \node [rotate=45] Hello; \\ \draw (0.2,0) circle (2mm); &amp; \fill[red] (0,0) circle (3mm); \\ };</pre>
--	--

	<pre>\matrix [fill=red!10,draw=blue,very thick] { \draw (0,0) circle (4mm); &amp; \node [rotate=45] Hello; \\ \draw (0.2,0) circle (2mm); &amp; \fill[red] (0,0) circle (3mm); \\ };</pre>
--	--

### 7.14.1 Alignement des cellules

PGFmanual section : 20-3

	anchor=base	anchor=north

	anchor=base	anchor=north

	<pre>\matrix [draw=red,nodes=draw] { \node[left] A; \fill[blue] (0,0) circle (2pt); \\ \node B; \fill[blue] (0,0) circle (2pt); \\ \node[right] C; \fill[blue] (0,0) circle (2pt); \\ };</pre>
--	--

<pre>\matrix [draw,column sep=1cm,nodes=draw]</pre>	
column sep=1cm	column sep={1cm,between origins }

<code>\matrix [draw,row sep=1cm,nodes=draw]</code>	
<code>row sep=1cm</code>	<code>row sep={1cm,between origins }</code>

<code>\matrix [ row sep=5mm,draw,nodes=draw]</code> <code>{ \node {1}; &amp; \node {2}; &amp; \node {3}; \\</code> <code>\node {4}; &amp; \node {5}; &amp; \node {6}; \\ [1cm]</code> <code>\node {7}; &amp; \node {8}; &amp; \node {9}; \\ }</code>	
<code>[1cm]</code>	<code>[1cm,between origins]</code>

<code>\matrix [ column sep=5mm,draw,nodes=draw]</code> <code>{ \node {1}; &amp; \node {2}; &amp; \node {3}; \\</code> <code>\node {4}; &amp; \node {5}; &amp; [1cm]\node {6}; \\</code> <code>\node {7}; &amp; \node {8}; &amp; \node {9}; \\ }</code>	
<code>[1cm]</code>	<code>[1cm,between origins]</code>

<code>row sep=1cm</code>

### 7.14.2 Format des cellules

<code>\matrix [nodes=draw,nodes={fill=blue!10,minimum size=1cm}]</code>		

\matrix[row 2/.style={red}]		
8 1 6 3 5 7 4 9 2	8 1 6 3 5 7 4 9 2	8 1 6 3 5 7 4 9 2
row 2/.style={red}	column 2/.style={red}	row 2 column 2/.style={red}

\matrix[column 1/.style={anchor=west}]		
12345 67890 123 67 1 6	12345 67890 123 67 1 6	12345 67890 123 67 1 6
[column 1/.style=anchor=west]	[column 1/.style=anchor=east]	[column 1/.style=anchor=base]

\matrix[matrix of nodes,every odd column/.style=red]			
a b c d e f g h i j k l	a b c d e f g h i j k l	a b c d e f g h i j k l	a b c d e f g h i j k l
every odd column	every even column	every odd row	every even row

\matrix [draw,matrix of nodes,execute at begin cell={({})]
(1 (2 (4 (6 (9

\tikz [matrix of nodes/.style={ execute at begin cell=\node\bgroup , execute at end cell=\$m^2\$\egroup; }] \matrix [draw,matrix of nodes ]
1 m <sup>2</sup> 2 m <sup>2</sup> 4 m <sup>2</sup> 6 m <sup>2</sup> 8 m <sup>2</sup> 9 m <sup>2</sup>

\matrix [raw,matrix of nodes, execute at empty cell=\node{- -}; ]
1 2 - 4 - 6 - - 9

### 7.14.3 Points d'ancrage

PGFmanual section : 20-4

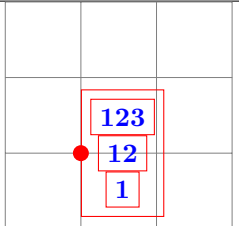
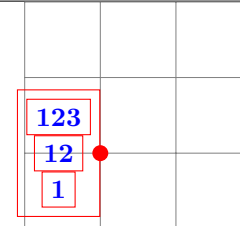
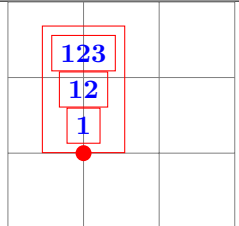
<code>\matrix [draw=red,nodes=draw,matrix anchor=east](XXX) at (1,1)</code>		
		
matrix anchor=west	matrix anchor=east	matrix anchor=south

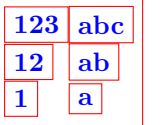
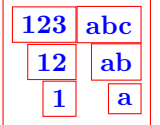
<code>\matrix [draw=red,nodes=draw,anchor=west]</code>	
	
anchor=west	anchor=east

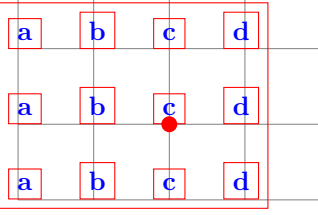
	<code>\matrix[draw=red,nodes=draw, matrix anchor=inner node.south, anchor=base, row sep=5mm,column sep=5mm] at (2,1) { \node {a}; &amp; \node {b}; &amp; \node {c}; &amp; \node {d}; \\ \node {a}; &amp; \node {b}; &amp; \node(inner node){c}; &amp; \node {d}; \\ \node{a}; &amp; \node {b}; &amp; \node{c}; &amp; \node {d}; \\ };</code>
--	--

### 7.14.4 Changement du séparateur

PGFmanual section : 20-5

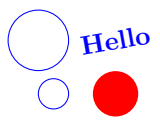
	<code>\tikz \matrix [ampersand replacement=\\ ] { \draw (0,0) circle (4mm); \\\ \node[rotate=10] {Hello}; \\ \draw (0.2,0) circle (2mm); \\\ \fill[red] (0,0) circle (3mm); \\ };</code>
---	--

### 7.15 Matrice de nœuds (compléments)

Charger l'extension: `\usetikzlibrary{matrix}`

PGFmanual section : 57-1

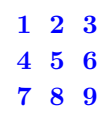
	<code>\begin{tikzpicture} \matrix [matrix of nodes] { 1 &amp; 2 &amp; 3 \\ 4 &amp; 5 &amp; 6 \\ 7 &amp; 8 &amp; 9 \\ }; \end{tikzpicture}</code>
---	--



	<pre> \begin{tikzpicture} \matrix (XXX) [matrix of nodes,column sep=.5cm,row sep=.5cm,every node/.style=draw] { 1 &amp; 2 &amp; 3 \\ 4 &amp; 5 &amp; 6 \\ 7 &amp; 8 &amp; 9 \\ }; \draw[thick,red,-&gt;] (XXX-1-1) -- (XXX-2-3) ; \end{tikzpicture} </pre>
--	--

	<pre> 1 &amp; 2 &amp; 3 \\ 4 &amp; 5 &amp;  [red] 6 \\ 7 &amp; 8 &amp; 9 </pre>
--	---

	<pre> AAA &amp;  [circle] BBB \\ CCC &amp;  [isosceles triangle] DDD \\  [ellipse] EEE &amp; FFF </pre>
--	---

	<pre> \matrix [matrix of nodes,column sep=.5cm,row sep=.5cm,every node/.style=draw] {  [a] AAA &amp;  [b] BBB \\  [c] CCC &amp;  [d] DDD \\  [e] EEE &amp;  [f] FFF \\ }; \draw (a) -- (d); \draw (d) -- (f); </pre>
--	--

	<pre> 1 &amp; [1cm] 2 &amp; [5mm]  [red] 3 \\ 4 &amp; 5 &amp; 6 \\ 7 &amp; 8 &amp; 9 </pre>
--	---

	<pre> \matrix [matrix of math nodes] { A_1 &amp; A_2 &amp; A_3 \\ a_4 &amp; a_5 &amp; a_6 \\ a^7 &amp; a^8 &amp; a^9 \\ }; </pre>
--	---

	<pre>\matrix [matrix of math nodes,nodes=circle,draw] { A_1 &amp; &amp; A_3 \\ a_4 &amp; &amp; a_6 \\ a_7 &amp; a_8 &amp; \\ };</pre>
--	---

	<pre>\matrix [matrix of math nodes,nodes=circle,draw ,nodes in empty cells] { A_1 &amp; &amp; A_3 \\ a_4 &amp; &amp; a_6 \\ a_7 &amp; a_8 &amp; \\ };</pre>
--	---

### 7.15.1 Texte dans les nœuds

[PGFmanual section : 57-2](#)

	<pre>\matrix [matrix of nodes,nodes={text width=2cm,draw} ] { aaa &amp; bbb \\ ccc &amp; \\ eee &amp; fff \\ };</pre>
--	---

	<pre>\matrix [matrix of nodes,nodes={text width=2cm,draw} ] { 1 &amp; &amp; {aaa \\ bbb \\ ccc} \\ 2 &amp; &amp; ddd \\ };</pre>
--	--

### 7.15.2 Délimiteurs

[PGFmanual section : 57-3](#)

<pre>\matrix [matrix of math nodes,left delimiter=( ]</pre>			
<pre>left delimiter=(</pre>	<pre>right delimiter=}</pre>	<pre>above delimiter=  </pre>	<pre>below delimiter=\rmoustache</pre>

```
\tikz \node [fill=red!20,text width=2cm,left delimiter=\{ ]
{Ceci est une démonstration d'un texte sur une largeur de 2cm.};
```

## 7.16 Matrice de nœuds

### 7.16.1 Création d'une chaîne de nœuds

Charger l'extension: `\usetikzlibrary{chains}`

PGFmanual section : 46-2

<pre>\begin{tikzpicture}[start chain] \node [on chain] {A}; \node [on chain] {B}; \node [on chain] {C}; \end{tikzpicture}</pre>

<pre>\begin{tikzpicture}[start chain, node distance= 0.5 cm]</pre>

<pre>\begin{tikzpicture}[start chain=going below ]</pre>

<pre>\begin{tikzpicture}[start chain=going left ]</pre>

<pre>\begin{tikzpicture}[start chain, every node/.style=draw ]</pre>

	<pre>\begin{tikzpicture}[start chain=1 going right , start chain=2 going left] \node [draw,on chain=1] {A}; \node [draw,on chain=1] {B}; \node[draw,on chain=1] {C}; \node [draw,on chain=2] at (3,1) {0}; \node [draw,on chain=2] {1}; \node [draw,on chain=2] {2}; \node[draw,on chain=1] {D}; \end{tikzpicture}</pre>
--	--

	<pre> \begin{tikzpicture}[start chain going right] \node [draw,on chain] {A}; \node [draw,on chain] {B}; \node [draw,continue chain=going below,on chain] {C}; \node[draw,on chain] {D}; \node [draw,continue chain=going right,on chain] {E}; \end{tikzpicture} </pre>
--	---

	<pre> \begin{tikzpicture}[start chain going right] { [start chain=1] \node [draw,on chain] {A}; \node [draw,on chain] {B}; \node [draw,on chain] {C}; } { [start chain=2] \node[draw,on chain=2] {0}; \node[draw,on chain=2] {1}; \node[draw,on chain=2] {2}; } { [continue chain=1] \node [draw,on chain] {D}; } \end{tikzpicture} </pre>
--	--

### 7.16.2 Nœuds sur la chaîne

[PGFmanual section : 46-3](#)

	<pre> \begin{tikzpicture}[start chain=XXX placed {at=(\tikzchaincount*-30+90:1.5)}}] \foreach \i in {1,...,12} \node [on chain] {\i}; \draw (0,0) - (XXX-10); \draw (0,0) - (XXX-2); \end{tikzpicture} </pre>
--	---

	<pre> \begin{tikzpicture}[start chain] \node [draw,on chain] {A}; \node [draw,on chain] {B}; \node [draw,on chain=going below] {C}; \node [draw,on chain] {D}; \node [draw,on chain] {E}; \end{tikzpicture} </pre>
--	--

	<pre> \begin{tikzpicture}[start chain=going {at=(\tikzchainprevious,shift=(30:1)}}] \node [draw,on chain] {A}; \node [draw,on chain] {B}; \node [draw,on chain] {C}; \node [draw,on chain] {D}; \end{tikzpicture} </pre>
--	--

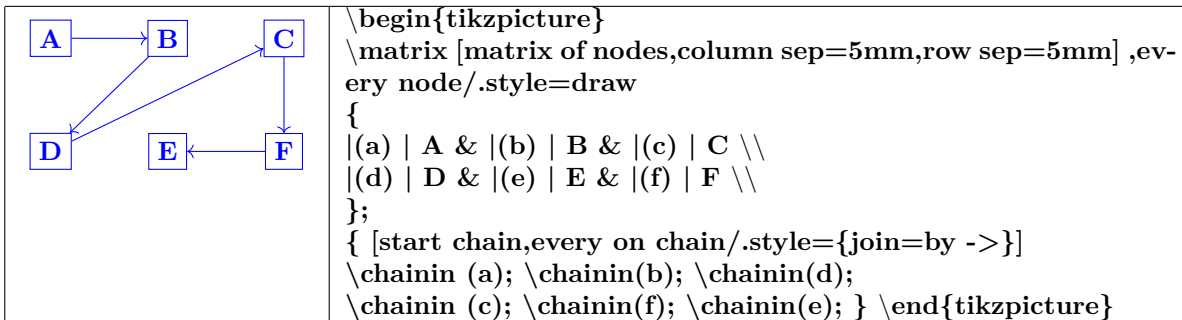
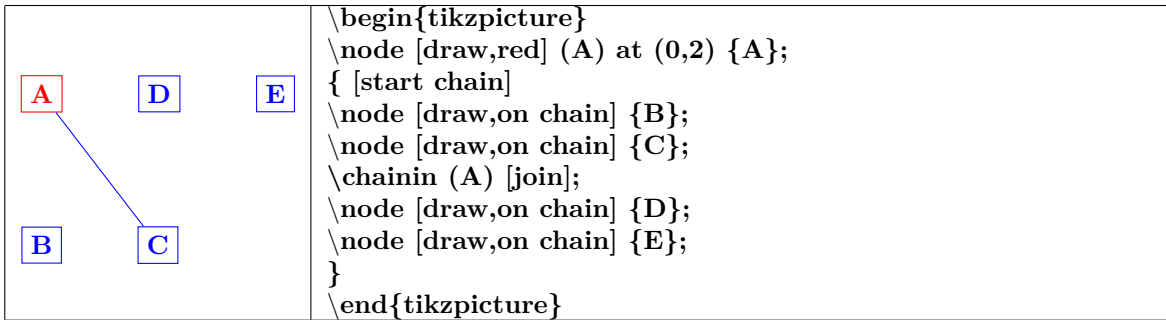

### 7.16.3 Jonction de nœuds

[PGFmanual section : 46-4](#)

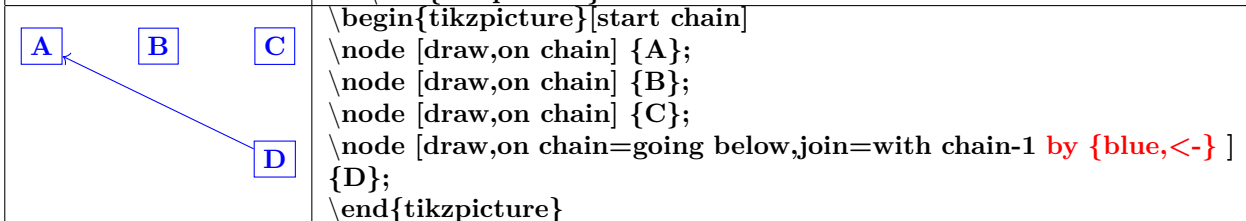
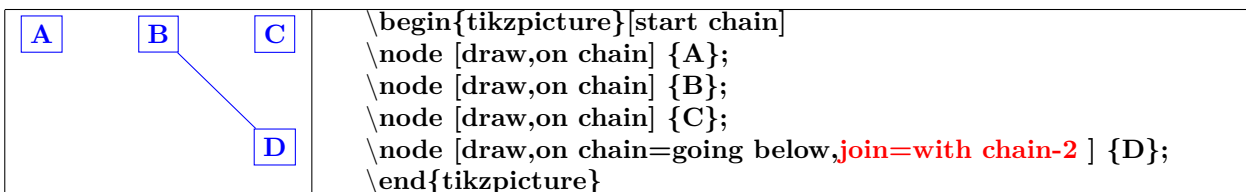
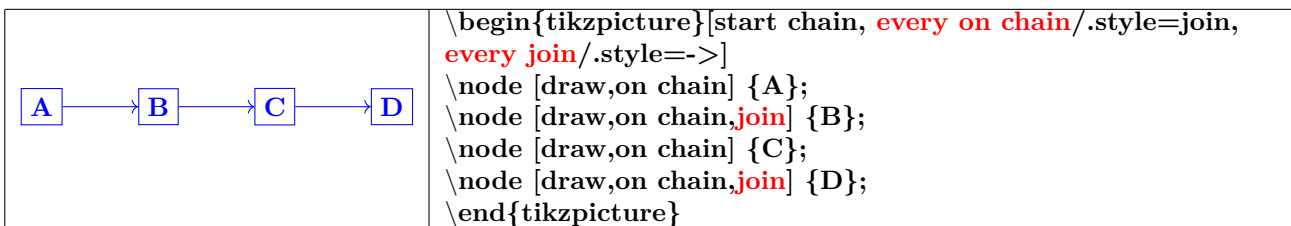
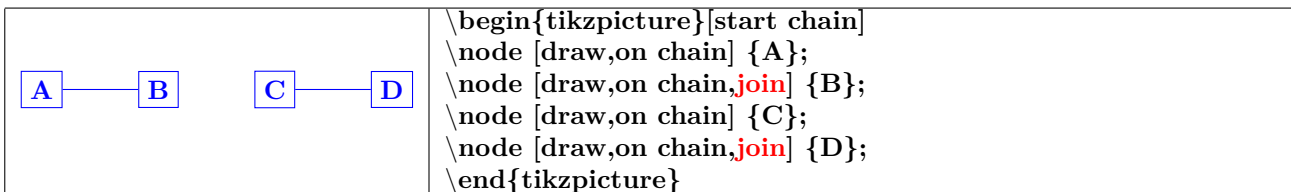

### 7.16.4 Branches

PGFmanual section : 46-5

	<pre> \begin{tikzpicture} { [start chain=XXX] \node [draw,on chain] {A}; \node [draw,on chain] {B}; { [start branch=YYY going below] \node [draw,on chain] {1}; \node [draw,on chain] {2}; \node [draw,on chain] {3}; } \node [ draw,on chain,join=with XXX/YYY-end, join=with XXX/YYY-2] {C}; } \end{tikzpicture} </pre>
--	---

<pre>\begin{tikzpicture}[ node distance=.2cm and 3cm]</pre>	

	<pre> \begin{tikzpicture}[ node distance=2mm and 1cm] { [start chain=XXX] \node [draw,on chain] {A}; \node [draw,on chain] {B}; { [start branch=YYY going below] \node [draw,on chain] {1}; \node [draw,on chain] {2}; \node [draw,on chain] {3}; } \node [draw,on chain,join=with XXX/YYY-end] {C}; { [continue branch=YYY] \node [on chain] {4}; \node [on chain] {5}; } } \end{tikzpicture} </pre>
--	---

	<pre> \begin{tikzpicture}[node distance=2mm and 1cm, every node/.style=draw] { [start chain] \node [on chain] {1}; \node [on chain] {2}; { [start branch=XXX going below] } \node [on chain] {3}; { [start branch=YYY going above] } \node [on chain] {4}; { [continue branch=XXX] } \node [on chain] {a}; \node [on chain] {b};} { [continue branch=YYY] } \node [on chain] {A}; \node [on chain] {B}; } </pre>
--	--

## 8 Constructions particulières

[PGFmanual section : 25-3](#)

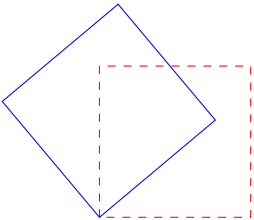
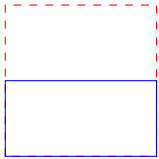
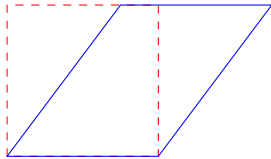
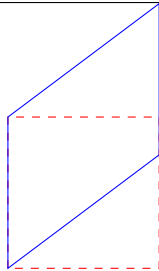
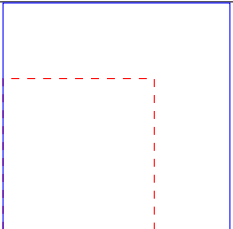
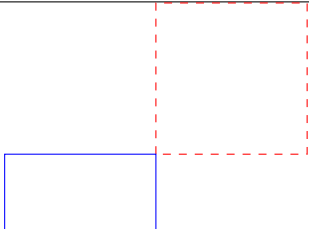
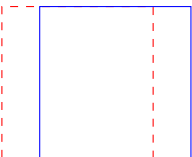
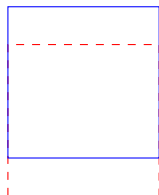
<code>\draw[rotate,blue] (0,0) rectangle (2,2) ;</code>			
			
<b>rotate=40</b>	<b>x=1cm,y=0.5cm</b>	<b>xslant=0.75</b>	<b>yslant=0.75</b>
			
<b>scale=1.5</b>	<b>scale=-1</b>	<b>xshift=0.5cm</b>	<b>yshift=0.5cm</b>

## 9 Placer son dessin

### 9.1 Dans le texte

#### 9.1.1 Sans option de décalage

PGFmanual section : 12-2

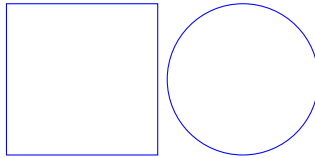

dessin directement dans le texte ici est inclus le code suivant  
: `\tikz \draw (0,0) rectangle(2,2);\tikz \draw (0,0) circle (1);`

#### 9.1.2 Avec décalage nul

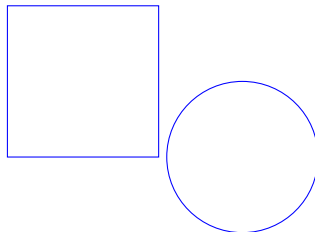

dessin directement dans le texte ici est inclus le code suivant :

`\tikz[baseline=0pt] \draw (0,0) rectangle(2,2);\tikz[baseline=0pt] \draw (0,0) circle (1);`

#### 9.1.3 Avec décalage

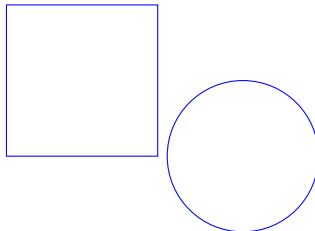

dessin directement dans le texte ici est inclus le code suivant

: `\tikz[baseline=1cm] \draw (0,0) rectangle(2,2);\tikz[baseline=1cm] \draw (0,0) circle (1);`



## 9.2 Dans un environnement tikzpicture

PGFmanual section : 12-1

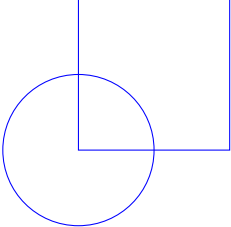
	<pre> texte avant \begin{tikzpicture}[blue] \draw (0,0) rectangle(2,2); \draw (0,0) circle (1); \end{tikzpicture} texte après         </pre>
---	--

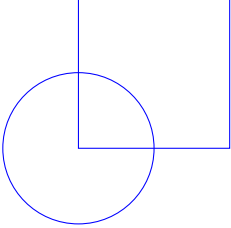
	<pre> texte avant \begin{tikzpicture}[blue,baseline=0pt] \draw (0,0) rectangle(2,2); \draw (0,0) circle (1); \end{tikzpicture} texte après         </pre>
---	---

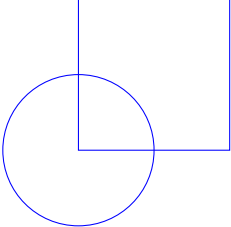
	<pre> texte avant \begin{tikzpicture}[blue,baseline=1cm] \draw (0,0) rectangle(2,2); \draw (0,0) circle (1); \end{tikzpicture} texte après         </pre>
--	---

## 9.3 Dans un environnement fbox

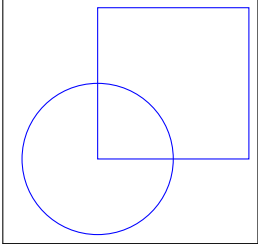
	<pre> texte avant \fbbox{ \begin{tikzpicture}[blue,baseline=0pt] \draw (0,0) rectangle(2,2); \draw (0,0) circle (1); \end{tikzpicture} } texte après         </pre>
---	---

## 9.4 Modification du cadrage

PGFmanual section : 15-8

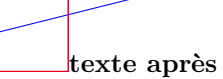
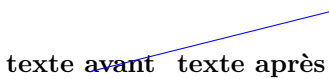
<pre> \draw [use as bounding box] (1,0) rectangle (2,1); \draw[blue] (-1,0) - - (3,1);         </pre>	
	
<pre>(1,0) rectangle (2,1)</pre>	<pre>(0,0) rectangle (0,0)</pre>

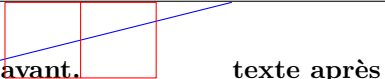
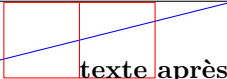
<pre> texte avant. \begin{tikzpicture} [trim left=1cm] \draw[blue] (-1,0) -- (3,1); \draw[red] (0,0) grid (2,1); \end{tikzpicture}texte après </pre>	
 <pre> [trim left=1cm] </pre>	 <pre> [trim right= 1cm] </pre>

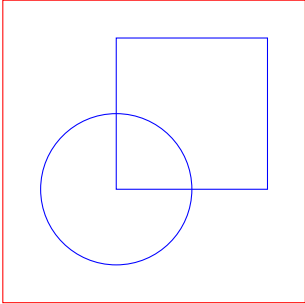
<pre> texte avant \begin{tikzpicture}[blue] \draw [red,use as bounding box] (-1.5,-1.5) rectangle (2.5,2.5); \draw (0,0) rectangle(2,2); \draw (0,0) circle (1); \end{tikzpicture} texte après </pre>	
---	---

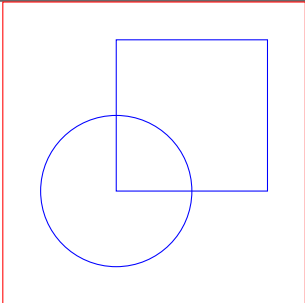
<pre> texte avant \begin{tikzpicture}[blue,baseline=0pt] \draw [red,use as bounding box] (-1.5,-1.5) rectangle (2.5,2.5); \draw (0,0) rectangle(2,2); \draw (0,0) circle (1); \end{tikzpicture} texte après </pre>	
--	--

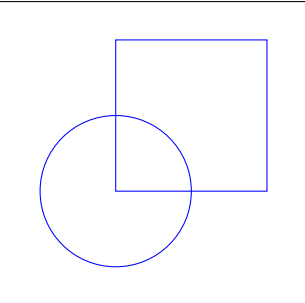
<pre> texte avant \begin{tikzpicture}[blue,baseline=0pt] \useasboundingbox (-1.5,-1.5) rectangle (2.5,2.5); \draw (0,0) rectangle(2,2); \draw (0,0) circle (1); \end{tikzpicture} texte après </pre>	
--	---

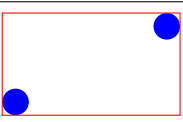
	<pre> \begin{tikzpicture}[blue] \fill (0,0) circle (5pt); \fill (2,1) circle (5pt); \draw[red] (current bounding box.south west) rectangle (current bounding box.north east); \end{tikzpicture} </pre>
---	--

## 9.5 Coupure de l'image

PGFmanual section : 15-9

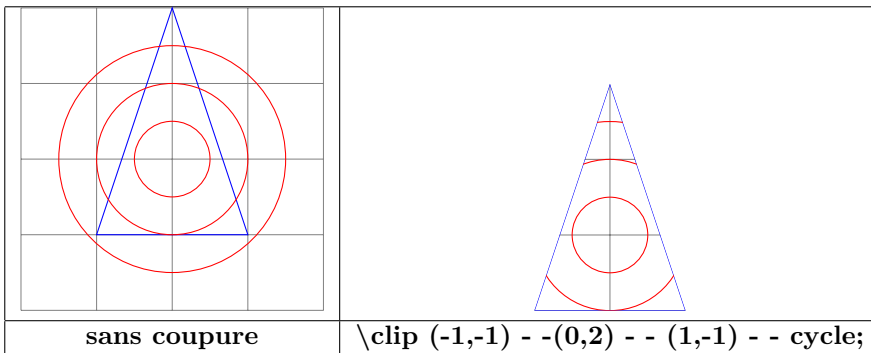

## 9.6 Rognage partiel

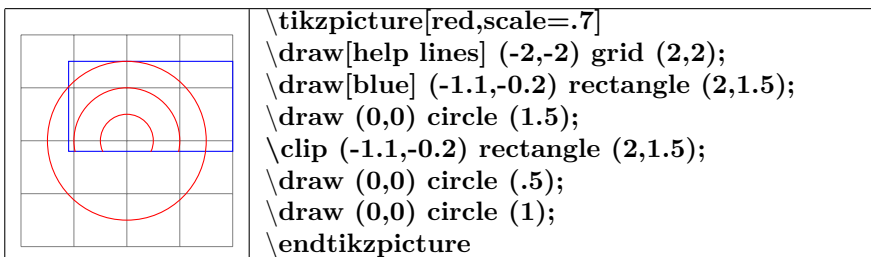

### 9.6.1 Changement d'échelle

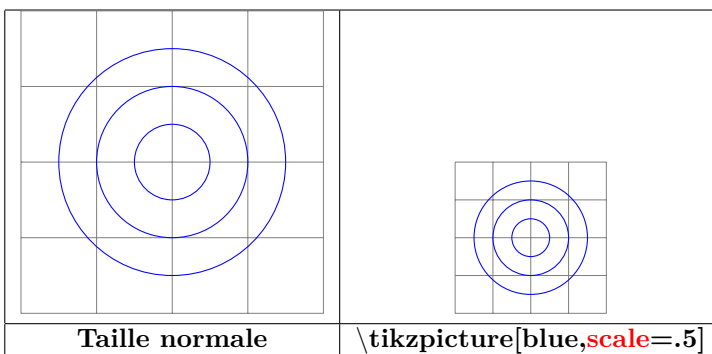

## 10 Scope

### 10.1 Environnement Scope

[PGFmanual section : 12-3](#)

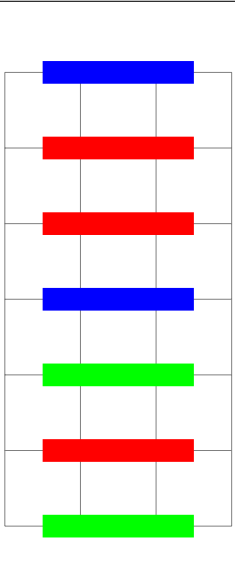
<pre>\begin{tikzpicture}[line width = 3mm]  \draw (0.5,6) - - (2.5,6);  \begin{scope}[red] \draw (0.5,5) - - (2.5,5); \draw (0.5,4) - - (2.5,4); \end{scope}  \draw (0.5,3) - - (2.5,3);  \begin{scope}[green] \draw (0.5,2) - - (2.5,2); \draw [red] (0.5,1) - - (2.5,1); \draw (0.5,0) - - (2.5,0); \end{scope}  \end{tikzpicture}</pre>	
--	--

### 10.2 library scopes

#### 10.2.1 Simplification d'un environnement scope

[PGFmanual section : 12-3-2](#)

Charger l'extension: `\usetikzlibrary{scopes}`

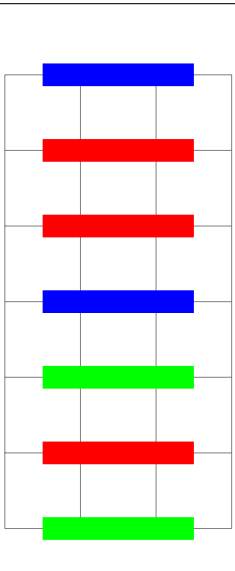
<pre>\begin{tikzpicture}[line width = 3mm]  \draw (0.5,6) - - (2.5,6);  { [red] \draw (0.5,5) - - (2.5,5); \draw (0.5,4) - - (2.5,4); }  \draw (0.5,3) - - (2.5,3);  { [green] \draw (0.5,2) - - (2.5,2); \draw [red] (0.5,1) - - (2.5,1); \draw (0.5,0) - - (2.5,0); }  \end{tikzpicture}</pre>	
--	--

### 10.2.2 Portée d'un seul élément

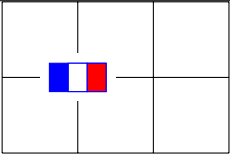
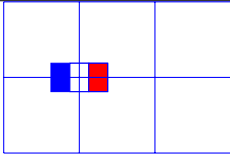
	
<pre>\node [fill=white] at (1,1) {\DFR}; \scoped [on background layer] \draw (0,0) grid (3,2);</pre>	<pre>\node [fill=white] at (1,1) {\DFR}; \draw (0,0) grid (3,2);</pre>

North west

North

North east

## 11 Position absolue sur une page

```

\begin{tikzpicture}[remember picture,overlay]
\fill(current page.north) circle (5pt) node[below left=4mm] \Huge north ;
\fill(current page.north east) circle (5pt) node[below left=4mm] \Huge north east ;
\fill(current page.north west) circle (5pt) node[below right=4mm] \Huge north west ;
\fill(current page.east) circle (5pt) node[above left=4mm] \Huge east ;
\fill(current page.center) circle (5pt) node[above left=4mm] \Hugecenter ;
\fill(current page.west) circle (5pt) node[above right=4mm] \Huge west ;
\fill(current page.south) circle (5pt) node[above right=4mm] \Huge south ;
\fill(current page.south west) circle (5pt) node[above right=4mm] \Huge south west ;
\fill(current page.south east) circle (5pt) node[above left=4mm] \Huge south east ;
\end{tikzpicture}

```

```

\begin{tikzpicture}[remember picture,overlay]
\node [opacity=.15] at (current page.center) {\includegraphics[width=8cm]{tiger} };
\end{tikzpicture}

```

```

\begin{tikzpicture}[remember picture,overlay]
\draw[dotted,opacity=.4] (current page.south west) -- (current page.north east)
node[near start] {\Huge TIKZ} ;
\end{tikzpicture}

```

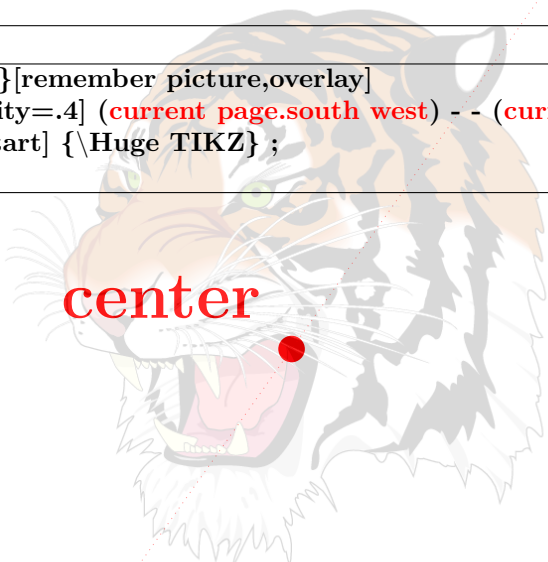

West

center

east

TIKZ

South west

South

South east

## 12 Arrière plan du dessin

### 12.1 Encadrement

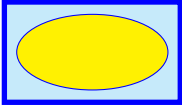
	<sup>1</sup> <pre>\begin{tikzpicture}[show background rectangle] \filldraw[fill=yellow] (0,0) ellipse (1 and .5 ); \end{tikzpicture}</pre> <p><i>Autre syntaxe :</i>  <pre>\begin{tikzpicture}[framed]</pre></p>
---	---

#### 12.1.1 Options

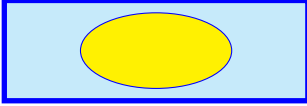
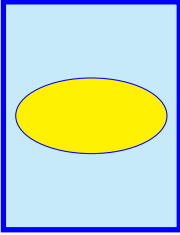
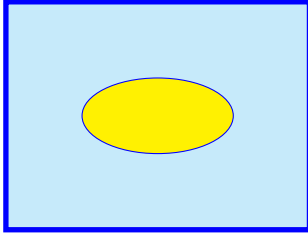
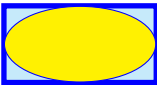
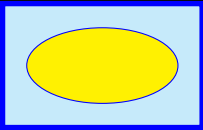
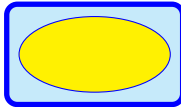
[show background rectangle,inner frame xsep=1cm]		
		
<b>inner frame xsep=1cm</b>	<b>inner frame ysep=1cm</b>	<b>inner frame sep=1cm</b>
Par défaut : : inner frame xsep=1ex , inner frame ysep=1ex		
		
<b>tight background</b> (inner frame sep = 0pt)	<b>loose background</b> (inner frame sep = 2ex)	<b>rounded corners</b>

#### 12.1.2 Style

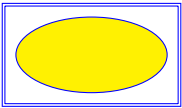
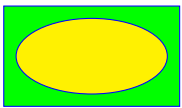
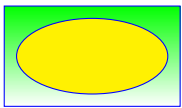
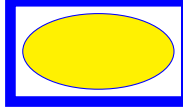
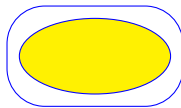
[background rectangle/.style={double,draw=blue},framed]				
				
<b>double</b>	<b>fill=green</b>	<b>top color=green</b>	<b>line width=4pt</b>	<b>rounded corners=0.5cm</b>

### 12.2 Encadrement partiel

			
<b>show background top</b>	<b>show background bottom</b>	<b>show background left</b>	<b>show background right</b>

<sup>1</sup>\tikzset{background rectangle/.style={fill=cyan!20,draw=blue,line width=2pt}}

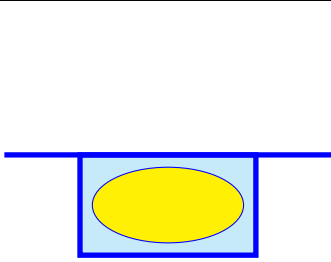
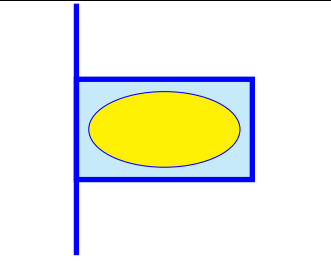
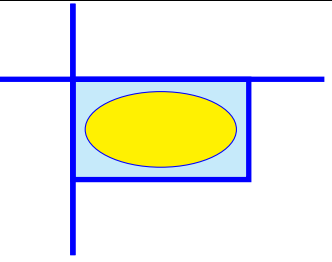
<code>[framed,show background top,outer frame xsep=1cm]</code>		
		
<code>outer frame xsep=1cm</code>	<code>outer frame ysep=1cm</code>	<code>outer frame sep=1cm</code>

### 12.2.1 Style

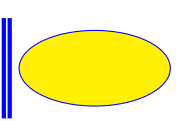
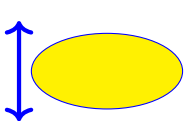
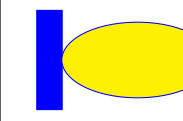
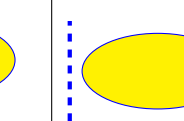
<code>\begin{tikzpicture}[show background left, [background left/.style={double,ultra thick,draw=blue}]</code>			
			
<code>double</code>	<code>&lt;-&gt;</code>	<code>line width=10pt</code>	<code>dashed</code>

### 12.2.2 Quadrillage

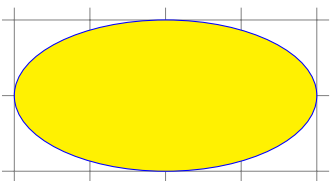
	<pre>\begin{tikzpicture}[show background grid] \filldraw[fill=yellow] (0,0) ellipse (2 and 1); \end{tikzpicture}</pre> <p><i>Autre syntaxe :</i>  <code>\begin{tikzpicture}[gridded]</code></p>
--	---

### 12.2.3 Style

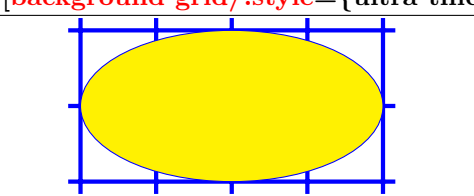
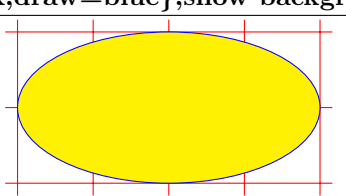
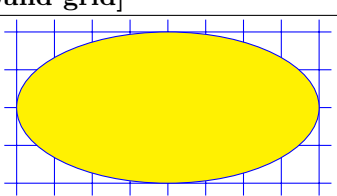
<code>[background grid/.style={ultra thick,draw=blue},show background grid]</code>		
		
<code>ultra thick ,draw=blue,draw=blue</code>	<code>draw=red</code>	<code>step=.5cm,draw=blue</code>



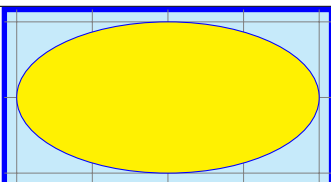









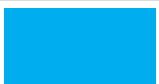





### 12.2.4 Encadrement et quadrillage



	<pre>\begin{tikzpicture}[framed , gridded ] \filldraw[fill=yellow] (0,0) ellipse (2 and 1); \end{tikzpicture}</pre>
---	---



## 13 Créer ses couleurs

### 13.1 Couleurs de base

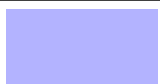
				
black	blue	brown	cyan	darkgray
				
gray	green	lightgray	lime	magenta
				
olive	orange	pink	purple	red
				
teal	violet	white	yellow	

				
[blue!10]	[blue!30]	[blue!50]	[blue!70]	[blue!90]

### 13.2 Mélange de couleurs

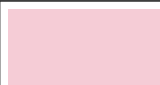
			
[blue!30!red]	[red!80!blue!20]	[red!80!blue!50]	[red!80!blue!50!black!40]



### 13.3 Créer son nom de couleur

[PGFmanual section : 15-2](#)

#### 13.3.1 A pourcentage de rouge vert et bleue

	<pre>\definecolor{<b>macouleur</b>}{rgb}{.75,0.5,0.25} (75% de rouge 50% de vert 25% de bleu) \fill [<b>macouleur</b>] (0,0) rectangle (2,1);</pre>
---	---

#### 13.3.2 A partir d'une couleur existante

	<pre>\colorlet{<b>monrouge</b>}{red!25} \fill [<b>monrouge</b>] (0,0) rectangle (2,1);</pre>
	<pre>\colorlet{<b>monviolet</b>}{red!25!blue} \fill [<b>monviolet</b>] (0,0) rectangle (2,1);</pre>

# 14 Opacité

[PGFmanual section : 23-2](#)





<code>\draw[red] (0,0) - (2,1);</code>		<code>\draw [blue,draw opacity=0] (0,1) - - (2,0);</code>		
<code>draw opacity=0</code>	<code>draw opacity=0.25</code>	<code>draw opacity=0.5</code>	<code>draw opacity=0.75</code>	<code>draw opacity=1</code>

<code>\fill[red] (0,0) rectangle (1,1);</code>		<code>\fill[blue,transparent] (0.5,0) rectangle (1.5,1);</code>	
<code>transparent</code>	<code>ultra nearly transparent</code>	<code>very nearly transparent</code>	<code>nearly transparent</code>
<code>semitransparent</code>	<code>nearly opaque</code>	<code>very nearly opaque</code>	<code>ultra nearly opaque</code>
<code>opaque</code>	<code>fill opacity=.25</code>	<code>fill opacity=.5</code>	<code>fill opacity=.75</code>

<code>\node at (1,1) [text opacity=1] { \Huge texte} ;</code>				
<code>text opacity=1</code>	<code>text opacity=0.75</code>	<code>text opacity=0.5</code>	<code>opacity=0.25</code>	<code>text opacity=0</code>

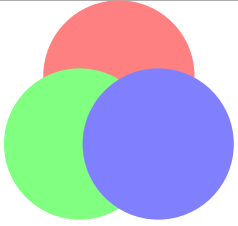
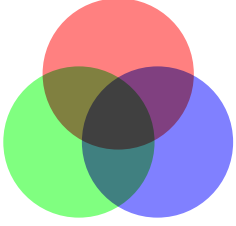
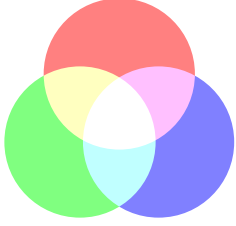
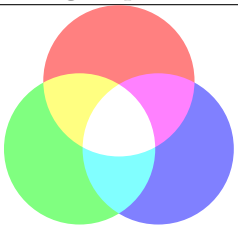
## 14.1 Blend Modes

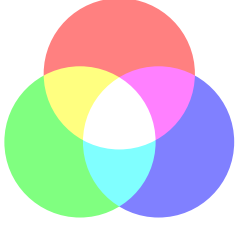
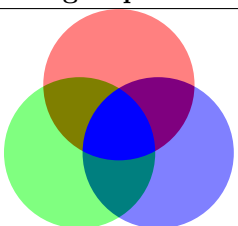
PGFmanual section : 23-3

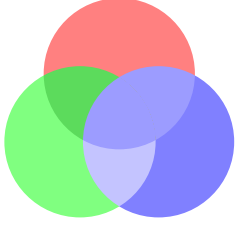
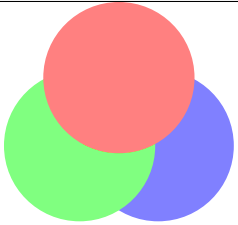
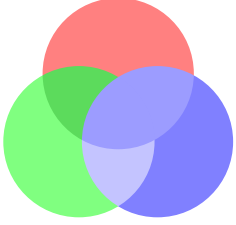
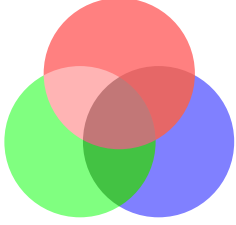
		
<code>blend group=normal</code>	<code>blend group=multiply</code>	<code>blend group=screen</code>
		
<code>blend group=overlay</code>	<code>blend group=darken</code>	<code>blend group=lighten</code>
		
<code>blend group=difference</code>	<code>blend group=exclusion</code>	<code>blend group=hue</code>
		
<code>blend group=saturation</code>	<code>blend group=color</code>	<code>blend group=luminosity</code>





A revoir message d'erreur Unknow blend mode !			
<code>blend group=colordodge</code>	<code>blend group=colorburn</code>	<code>blend group=hardlight</code>	<code>blend group=softlight</code>

## 14.2 Fading

Charger l'extension: `\usetikzlibrary{fadings}`

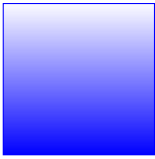

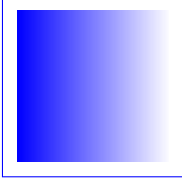
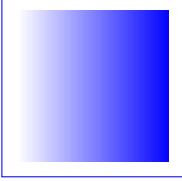
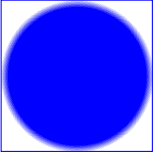
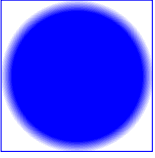
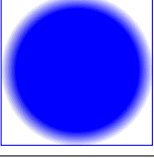
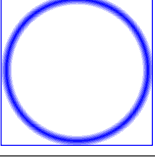
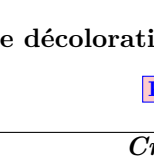
### 14.2.1 Modèles prédéfinis







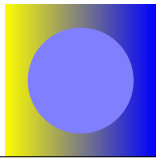

PGFmanual section : 51

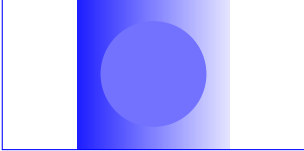

<code>\fill [blue,path fading=north] (-1,-1) rectangle (1,1);</code>			
			
path fading=north	path fading=south	path fading=east	path fading=west
			
path fading=circle with fuzzy edge 10 percent		path fading=circle with fuzzy edge 15 percent	
			
path fading=circle with fuzzy edge 20 percent		path fading=fuzzy ring 15 percent	
			

### 14.2.2 Création de décoloration avec tikzfadingfrompicture

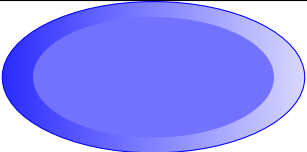

PGFmanual section : 23-4-1

<i>Création</i>	<i>Visualisation</i>
<pre>\begin{tikzfadingfrompicture}[name=filtre] \shade[left color=yellow,right color=blue!100] (0,0) rectangle (2,2); \fill[blue!50] (1,1) circle (0.7); \end{tikzfadingfrompicture}</pre>	
<pre>\begin{tikzfadingfrompicture}[name=tikz] \node [draw,text=transparent!20] {\fontfamily{ptm}\fontsize{25}{25}\bfseries\selectfont TikZ}; \end{tikzfadingfrompicture}</pre>	

Utilisation dans un rectangle	
<code>\fill[path fading=filtre] (-2,-1) rectangle (2,1);</code>	
	
<code>[path fading=filtre]</code>	<code>[path fading=tikz]</code>
	
<code>[path fading=filtre ,fit fading=false]</code>	<code>[path fading=tikz,fit fading=false]</code>
	
<code>left color=blue,right color=red</code>	<code>[path left color=blue,right color=red]</code>
	
<code>[path fading=filtre ,red]</code>	<code>[path fading=tikz,red]</code>

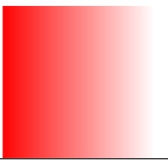
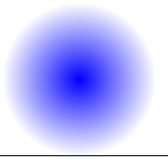
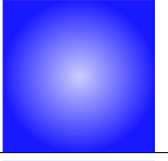

Utilisation dans un ellipse	
<code>\fill[path fading=filtre] (-2,-1) ellipse (2 and 1);</code>	
	
<code>[path fading=filtre]</code>	<code>[path fading=tikz]</code>

### 14.3 Création de décoloration avec tikzfading

<pre>\tikzfading[name=fade right, left color=transparent!0, right color=transparent!100]</pre> <pre>\tikz \filldraw [red,path fading=fade right] (-1,-1) rectangle (1,1);</pre>	
<pre>\tikzfading[name=fade out, inner color=transparent!0, outer color=transparent!100]</pre> <pre>\tikz \filldraw [blue,path fading=fade out] (-1,-1) rectangle (1,1);</pre>	
<pre>\tikzfading[name=fade inside, inner color=transparent!80, outer color=transparent!10]</pre> <pre>\tikz \filldraw [blue,path fading=fade inside] (-1,-1) rectangle (1,1);</pre>	
<pre>\tikzfading[name=middle, top color=transparent!80, bottom color=transparent!80, middle color=transparent!20]</pre> <pre>\tikz \filldraw [blue,path fading=middle] (-1,-1) rectangle (1,1);</pre>	

#### 14.3.1 Modification de la décoloration

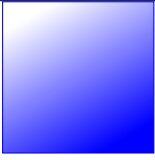
[PGFmanual section : 23-4-2](#)

<pre>\fill [blue,path fading=north,fading transform={yshift=-.5cm}] (-1,-1) rectangle (1,1);</pre>		
		
<code>fading transform={yshift=-.5cm}</code>	<code>fading transform={yshift=-.5cm}</code>	<code>fading angle=30</code>

[PGFmanual section : 23-4-3](#)

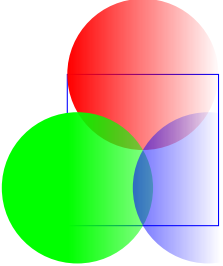
<pre>\begin{tikzpicture} \draw (-1,-1) rectangle (1,1); \path [scope fading=east] (-1,-1) rectangle (1,1); \fill[red] ( 90:1) circle (1); \fill[green] (210:1) circle (1); \fill[blue] (330:1) circle (1); \end{tikzpicture}</pre>	
--	--

<pre>\tikz \node [black,scope fading=south,fading angle=45,text width=5cm] { VisualTIKZ VisualTIKZ VisualTIKZ Visu- alTIKZ VisualTIKZ VisualTIKZ VisualTIKZ VisualTIKZ VisualTIKZ VisualTIKZ Visu- alTIKZ VisualTIKZ VisualTIKZ };</pre>	<pre>VisualTIKZ VisualTIKZ VisualTIKZ VisualTIKZ VisualTIKZ VisualTIKZ VisualTIKZ VisualTIKZ VisualTIKZ VisualTIKZ VisualTIKZ VisualTIKZ VisualTIKZ</pre>
--	---

## 14.4 Transparency Groups

PGFmanual section : 23-5

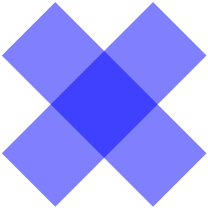
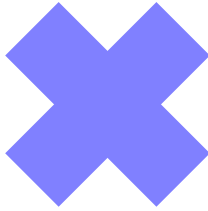
<pre>\begin{tikzpicture}[opacity=.5] \draw [line width=1cm] (0,0) – (2,2); \draw [line width=1cm] (0,2) – (2,0); \end{tikzpicture}</pre>	
	
[opacity=.5]	[opacity=.5,transparency group]

A revoir : ne fonctionne pas	
<pre>\begin{tikzpicture} \shade [left color=red,right color=blue] (-2,-1) rectangle (2,1); \begin{scope}[transparency group=knockout] \fill[white] (-1.9,-.9) rectangle (1.9,.9); \node [opacity=0] TikZ; \end{scope} \end{tikzpicture}</pre>	

## 15 Créer ses commandes

Charger l'extension: Attention : la création de la commande doit être placée avant `\begin{document}` !

syntaxe : `\newcommand{\nom}[nombre de variables]{Description}`

Exemple : commande avec une variable :

*Création*

```
\newcommand
{\maboite}[1]{          % commande nommée maboite et 1 seul d'argument
\begin{center}         % centrage sur la ligne
\tikzpicture \node[fill=yellow] % un nœud de texte de couleur jaune
,text centered        % centrage du texte dans la boîte
,text width=.5\linewidth] % largeur : la moitié de la ligne
#1} ; \end{center}    % #1 correspond à l'argument
}
```

*Utilisation* : `\maboite{contenu}`

Charger l'extension: contenu

Exemple : commande sans variable :

*Création*

```
\newcommand{\DFR}{\tikzpicture[scale=.25] \draw [fill=blue](0,0) rectangle (3,1.5);
\draw [fill=white](1,0) rectangle (2,1.5); \draw[fill=red](2,0) rectangle (3,1.5);\endtikzpicture }
```

*Utilisation* : `\DFR` 



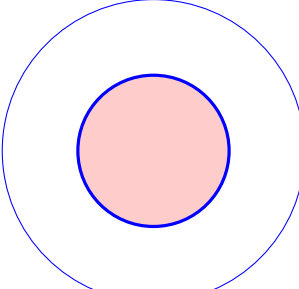

## 16 Créer ses styles

### 16.1 Styles sans variable

	<pre>\begin{tikzpicture} [mon style/.style={draw=blue, fill=red!20, very thick}] \draw (0,0) circle (2cm); \draw[mon style] (0,0) circle (1cm); \end{tikzpicture}</pre>
---	---

### 16.2 Styles avec variable







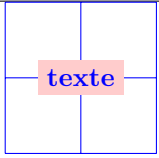
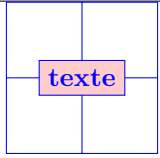
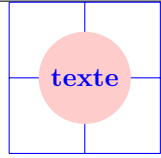
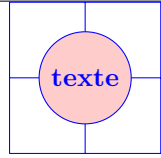

	<pre>\begin{tikzpicture} [mon style/.style={draw=#1, thick, fill=#1!50, scale=.5}] \filldraw [mon style=red] (0,0) rectangle (2,1); \filldraw [mon style=blue] (3,0) rectangle (5,1); \end{tikzpicture}</pre>
valeur par défaut	
	<pre>\begin{tikzpicture} [mon style/.style={draw=#1,fill=#1!20,very thick}, mon style/default=black] \filldraw [mon style] (0,0) rectangle (2,1); \filldraw [mon style=blue] (3,0) rectangle (5,1); \end{tikzpicture}</pre>



## 17 Mettre du texte en valeur

### 17.1 Dans un nœud de Tikz

\tikz \draw (0,0) grid (2,2) (1,1) node[ fill=red!20 ] {texte};			
			
node[fill=red!20]	node[fill=red!20,draw]	node[fill=red!20,circle]	node[fill=red!20,circle,draw]

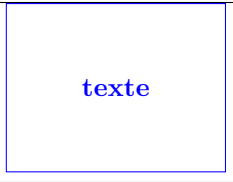
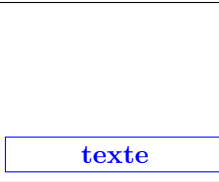

#### 17.1.1 Options

\tikz \draw node[draw,double,blue] {texte};							
							
double	rounded corners	ultra thick	dashed	red	rotate=45	shading=radial	text=red

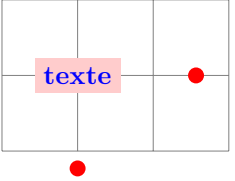
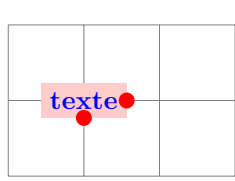
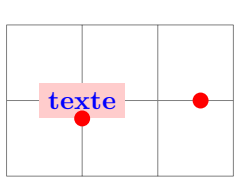
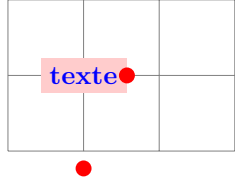
\tikz \draw node[draw,inner sep=0pt] {texte}; <a href="#">PGFmanual section : 17-2-3</a>			
			
inner sep=0pt	inner sep=1cm	inner xsep=1cm	inner ysep=1cm
Par défaut : : 0.3333em			

\node [fill=red!20,outer sep=1cm] (A) at (1,1) {texte}; <a href="#">PGFmanual section : 17-2-3</a> \fill (node cs:name=A,anchor=east) circle (3pt); \fill (node cs:name=A,anchor=south) circle (3pt);			
			
outer sep=1cm	outer sep=0pt	outer xsep=1cm	outer ysep=1cm
Par défaut : : 0.5\pgflinewidth			

#### 17.1.2 Taille minimale des nœuds

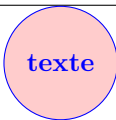
\draw((0,0) node[fill=blue!20,minimum height=1.5cm,draw] {texte} ; <a href="#">PGFmanual section : 17-2-3</a>	
	
minimum height=1.5cm	minimum width=3cm
	
minimum size=1.5cm,draw	minimum size=1.5cm,circle







## 17.2 Dans un nœud à formes géométriques

Charger l'extension: `\usetikzlibrary{shapes.geometric}`



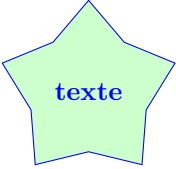
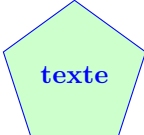
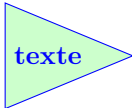
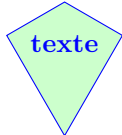
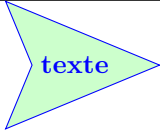
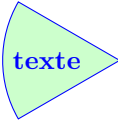

PGFmanual section : 67-3

### 17.2.1 Formes disponibles

2 syntaxes :  
`\tikz \node[fill=green!20,shape=diamond,draw,blue] {texte};`  
`\tikz \node[fill=green!20,diamond,draw] {texte};`

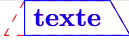
			
diamond	ellipse	trapezium	semicircle
			
star	regular polygon	isosceles triangle	kite
			
dart	circular sector	cylinder	

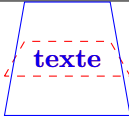
### 17.2.2 Options

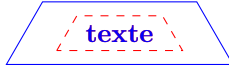

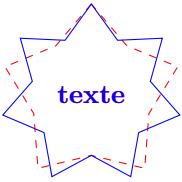
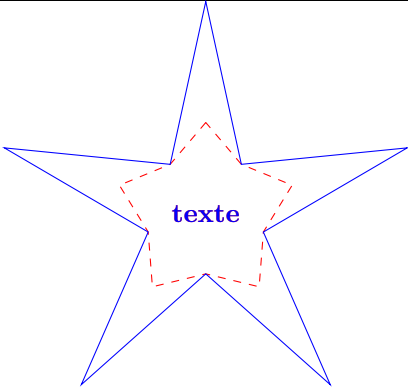
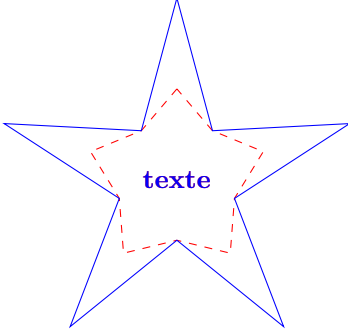

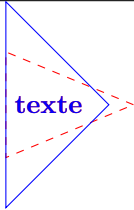
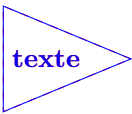
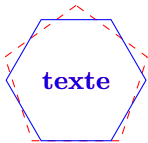
<code>\node [trapezium,draw, trapezium left angle=90,draw,blue] {texte};</code>		
		
<b>trapezium left angle=90</b>	<b>trapezium right angle=90</b>	<b>trapezium angle=120</b>
		
<b>minimum height=1.5cm</b> <b>trapezium stretches=true</b>	<b>minimum height=1.5cm</b> <b>trapezium stretches=false</b>	<b>minimum width=1.5cm</b> <b>trapezium stretches</b>

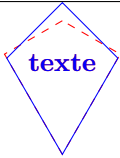
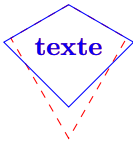
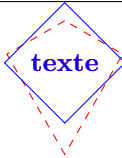

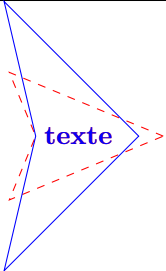
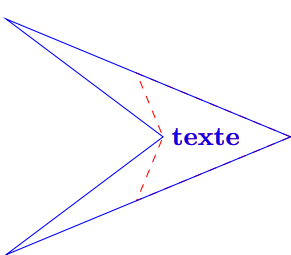
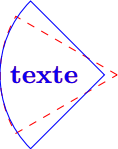

<code>\tikz \node [fill=green!20,star,star points=6,draw] {texte};</code>		
		
<code>star points=7</code>	<code>star point height = 2cm</code>	<code>star point ratio = 3</code>
Par défaut : 5	Par défaut : .5cm	Par défaut : 1.5

<code>\node [isosceles triangle,isosceles triangle apex angle=90,draw,blue] {texte};</code> <code>\node [regular polygon, regular polygon sides=6,draw,blue] {texte};</code>		
		
<code>isosceles triangle apex angle=90</code>	<code>isosceles triangle stretches</code>	<code>regular polygon sides=6</code>

<code>\node [kite,kite upper vertex angle=90,draw,blue] {texte};</code>		
		
<code>kite upper vertex angle=90</code> initially 120	<code>kite lower vertex angle=90</code> initially 60	<code>kite vertex angles=90</code>

<code>\node [dart,dart tip angle=90,draw,blue] {texte};</code>		
		
<code>dart tip angle=90</code> initially 45	<code>dart tail angle=90</code> initially 135	<code>circular sector angle=90</code> initially 60

<code>\node [cylinder,aspect=2,draw,blue] {texte};</code>	
	
<code>aspect=2</code>	<code>aspect=4</code>
	
<code>cylinder uses custom fill, cylinder end fill=yellow</code>	<code>cylinder uses custom fill, cylinder body fill=yellow</code>

<code>\draw(0,0) node[shape aspect=1,diamond,draw] {texte} ;</code>			
			
<code>shape aspect=1</code>	<code>shape aspect=2</code>	<code>shape aspect=3</code>	<code>shape aspect=4</code>

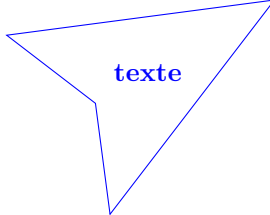



<code>\draw node[shape border rotate=30,shape=dart, draw, shape border uses incircle] {texte};</code>

### 17.3 Dans un nœud en forme de symboles

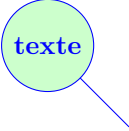

Charger l'extension: `\usetikzlibrary{shapes.symbols}`



PGFmanual section : 67-4

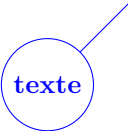
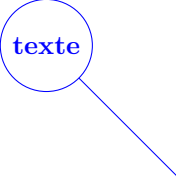

#### 17.3.1 Formes disponibles

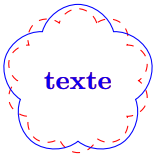
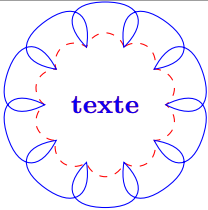

		
forbidden sign	magnifying glass	cloud
		
starburst	signal	tape



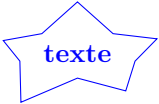
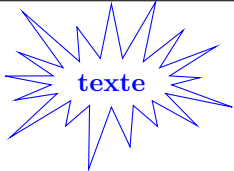

#### 17.3.2 Options





<code>\node[magnifying glass,magnifying glass handle angle=45,draw,blue] {texte} ;</code>		
		
<b>magnifying glass handle angle=45</b> Par défaut : : -45	<b>magnifying glass handle aspect=3</b> Par défaut : : 1.5	<b>line width=1ex</b>



<code>\node [cloud,cloud puffs=5,draw,blue] {texte};</code>			
			
<b>cloud puffs=5</b> Par défaut : : 10	<b>cloud puff arc=270</b> Par défaut : : 135	<b>cloud ignores aspect=false</b>	<b>cloud ignores aspect=true</b> Par défaut : : true







<code>\node [starburst,starburst points=5,draw,blue] {texte};</code>			
			
<b>starburst points=5</b>	<b>starburst point height=1cm</b>	<b>random starburst=50</b>	<b>random starburst=0</b>

<code>\node [signal,signal pointer angle=45,draw,blue] {texte};</code>		
		
<code>signal pointer angle=45</code>	<code>signal pointer angle=10</code>	<code>signal pointer angle=300</code>
Par défaut : : <code>signal pointer angle= 90</code>		

<code>\node [signal,signal to=above,draw,blue] {texte};</code>			
			
<code>signal to=above</code>	<code>signal to=below</code>	<code>signal to=right</code>	<code>signal to=above</code>

<code>\tikz [signal to=nowhere] \node [signal,signal from=above=45,draw,blue] {texte};</code>			
			
<code>signal from=above</code>	<code>signal from=below</code>	<code>signal from=right</code>	<code>signal from=above</code>

	
<code>signal from=east , signal to=west</code>	<code>signal from=south, signal to=north</code>

<code>\tikz \node [tape, draw,tape bend top=out and in] {texte};</code>		
		
<code>tape bend top=out and in</code>	<code>tape bend bottom=out and in</code>	<code>tape bend bottom=in and in</code>
		
<code>tape bend top=none</code>	<code>tape bend bottom=out and in tape bend top=out and in</code>	<code>tape bend bottom=in and out tape bend top=in and out (Par défaut : )</code>

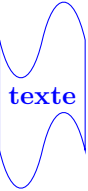

<code>\tikz \node [tape, draw, tape bend height=1cm,blue] {texte};</code>

Par défaut : : <code>tape bend height = 5pt</code>

## 17.4 Dans un nœud en forme de flèche

Charger l'extension: `\usetikzlibrary{shapes.arrows}`

PGFmanual section : 67-5

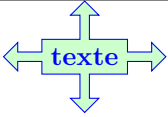
### 17.4.1 Formes disponibles

		
single arrow	double arrow	arrow box

### 17.4.2 Options

<code>\node[single arrow,draw, <b>single arrow tip angle=45</b>] {texte};</code>				
<code>\node[single arrow,draw, <b>single arrow head extend=.75cm</b>] {texte};</code>				
angle=45	angle=120	extend=.75cm]	extend=0cm	extend=-1mm
Par défaut : : single arrow tip angle= 90			Par défaut : : single arrow head extend=0.5cm	

<code>\node[minimum size=2cm,single arrow,draw, <b>single arrow head indent=1cm,blue</b>] {texte};</code>			
indent=1cm	indent=10pt	indent=1ex	indent=-1ex

<code>\node[minimum size=2cm,double arrow,draw, <b>double arrow tip angle=45</b>] {texte};</code>				
<code>\node[minimum size=2cm,double arrow,draw, <b>double arrow head extend=1ex</b>] {texte};</code>				
<code>\node[minimum size=2cm,double arrow,draw, <b>double arrow head indent=1ex</b>] {texte};</code>				
angle=45	angle=120	extend=1ex	extend=0	indent=1ex

<code>\node [arrow box, draw, <b>arrow box arrows={north:.25cm}</b>] {texte};</code>			
{north:.25cm}	{west:.25cm}	{south:.25cm}	{east:.25cm}
Par défaut : : 0.5 cm			



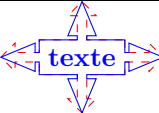
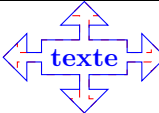
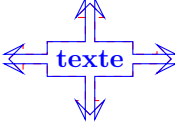
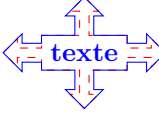

<code>\node [arrow box, draw, arrow box tip angle=45] {texte};</code>	
	
<b>arrow box tip angle=45</b>	<b>arrow box head extend=.25cm</b>
Par défaut : : 90	Par défaut : : 0.125cm
	
<b>arrow box head indent=.25cm</b>	<b>arrow box shaft width=.25cm</b>
Par défaut : : 0cm	Par défaut : : 0.125cm

## 17.5 Dans un nœud en forme de bulle







Charger l'extension: `\usetikzlibrary{shapes.callouts}`

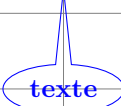

PGFmanual section : 67-7

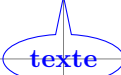

### 17.5.1 Formes disponibles





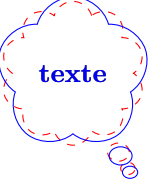

		
ellipse callout	rectangle callout	cloud callout

### 17.5.2 Options

<code>\node [rectangle callout,draw,callout absolute pointer=(0,1)] at (2,1) {texte};</code>			
			
<code>callout relative pointer={{(0,1)}}</code>		<code>callout absolute pointer={{(0,1)}}</code>	
			
<code>callout pointer shorten=.5cm</code>			

<code>\node [ellipse callout,draw,callout pointer arc=1] at (0,1.5) {texte};</code>		
		
<code>callout pointer arc=1</code>	<code>callout pointer arc=30</code>	<code>callout pointer arc=90</code>
Par défaut : <code>callout pointer arc=15</code>		

<code>\node[draw,cloud callout, aspect=2.5] {texte};</code>		
		
<code>cloud puffs=5</code>	<code>aspect=2.5</code>	<code>cloud puff arc=120</code>

<code>\node [draw,cloud callout,callout pointer start size=.1] {texte};</code>		
		
<code>callout pointer start size=.1</code>	<code>start size=.8cm</code>	<code>start size=20pt and 1pt</code>
Par défaut : : callout pointer start size =.2 of callout		
		
<code>callout pointer end size=.5</code>	<code>callout pointer end size=.8cm</code>	<code>callout pointer segments=3</code>
Par défaut : : callout pointer start size = .1 of callout		Par défaut : : segments=2

## 17.6 Dans un nœud en diverses formes diverses

Charger l'extension: `\usetikzlibrary{shapes.misc}`

PGFmanual section : 67-8

### 17.6.1 Formes disponibles

cross out	strike out	rounded rectangle	chamfered rectangle

### 17.6.2 Options

Options pour “rounded rectangle” :

<code>\node [draw, rounded rectangle,rounded rectangle arc length=270] {texte};</code>				
270	180	120	90	45

<code>\node [draw, rounded rectangle,rounded rectangle west arc=concave] {texte};</code>				<code>\node [draw, rounded rectangle,rounded rectangle left arc=concave] {texte};</code>	
concave	convex	none			





<code>\node [draw, rounded rectangle,rounded rectangle east arc=concave] {texte};</code>			<code>\node [draw, rounded rectangle,rounded rectangle right arc=concave] {texte};</code>		
concave	convex				none



Options pour “chamfered rectangle” :

<code>\node [draw, chamfered rectangle,chamfered rectangle angle=30] {texte};</code>				
10	30	60		80
Par défaut : : 45				

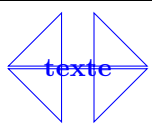
<code>\node [draw, chamfered rectangle,chamfered rectangle xsep=10pt] {texte};</code>				
xsep=0pt	xsep=5pt	xsep=10pt	xsep=-10pt	xsep=2cm
Par défaut : : 0.666ex				

<code>\node [draw, chamfered rectangle,chamfered rectangle ysep=10pt] {texte};</code>				
ysep=0pt	ysep=5pt	ysep=10pt	ysep=-10pt	ysep=1cm

<code>\node [draw, chamfered rectangle,<b>chamfered rectangle ysep=10pt</b>] {texte};</code>				
				
sep=0pt	sep=5pt	sep=10pt	sep=-10pt	sep=1cm

<code>\node [draw, chamfered rectangle,<b>chamfered rectangle corners=north west</b>] {texte};</code>		
		
north west	{north east, south east}	{north east, south west}

## 17.7 Nœuds à plusieurs parties

Charger l'extension: `\usetikzlibrary{shapes.multipart}`

PGFmanual section : 67-6

<code>\node [circle split,draw,fill=green!20]{haut \nodepart{lower} bas };</code>			
circle split	circle solidus	ellipse split	rectangle split

	<code>\node[rectangle split,rectangle split parts=5,draw]{texte 1\nodepart{second} texte 2\nodepart{four} texte 3};</code> Par défaut : : rectangle split parts=4
--	--



<code>\node [rectangle split,rectangle split parts=3,rectangle split horizontal,draw,blue]{texte1\nodepart{two}texte2\nodepart{three}texte3};</code>	

	<code>\node[rectangle split,rectangle split parts=5,draw]{texte 1\nodepart{second} texte 2a \\texte 2b \\texte 2c\nodepart{three} texte 3a \\ texte 3b };</code>
--	--

<code>\node[rectangle split, draw,blue,minimum size = 2cm,rectangle split draw splits= true]{texte 1 \nodepart{two} texte 2 \nodepart{three} texte 3 \nodepart{four} texte 4};</code>	
rectangle split draw splits= true Par défaut :	rectangle split draw splits= false

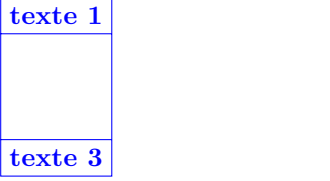
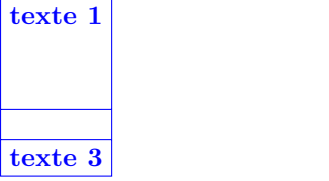
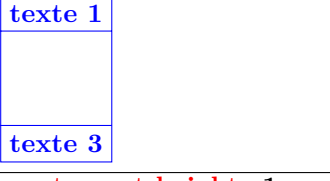
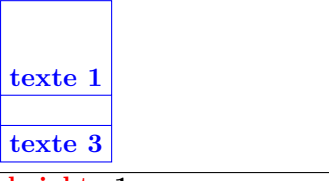
<code>\node [rectangle split,rectangle split parts=3,draw,rectangle split ignore empty parts=false]{texte 1 \nodepart{second} \nodepart{third}texte 3};</code>	
rectangle split ignore empty parts=false	rectangle split ignore empty parts=true

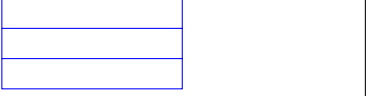
<pre>\node [rectangle split,rectangle split parts=3,draw,rectangle split empty part depth=1cm] {texte 1 \nodepart{second} \nodepart{third}texte 3};</pre>	
	
<b>rectangle split empty part depth=1cm</b>	<b>text depth=1cm</b>
Par défaut : : 0ex	Par défaut : : 0ex
	
<b>rectangle split empty part height=1cm</b>	<b>text height=1cm</b>
Par défaut : : 1ex	Par défaut : : 1ex

<pre>\node [rectangle split,rectangle split parts=3,draw,rectangle split empty part width=1cm] {};</pre>	
	
<b>rectangle split empty part width=2cm</b>	Par défaut : : 1ex

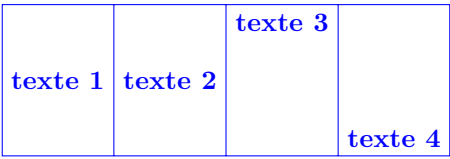
	<pre>\node[rectangle split, draw,blue,minimum size = 2cm, rectangle split part align={center, left,right}] {texte 1 \nodepart{two} texte 2 \nodepart{three} texte 3 \nodepart{four} texte 4};</pre>
	<pre>\node[rectangle split, draw,blue,minimum size = 2cm, rectangle split horizontal, rectangle split part align={center,base, top,bottom}] {texte 1 \nodepart{two} texte 2 \nodepart{three} texte 3 \nodepart{four} texte 4};</pre>

	<pre>\node[rectangle split, draw,blue, minimum width=1cm, rectangle split part fill={red, green,cyan}]{};</pre>
---	---

## 17.8 Mise en forme du texte

### 17.8.1 Position

PGFmanual section : 17-4-3

<code>\tikz \draw (0,0) node[fill=blue!10,text width=2cm,text justified] {Ceci est une démonstration d'un texte sur une largeur de 2cm};</code>			
sans option	<code>text justified</code>	<code>text centered</code>	<code>text ragged</code>
<code>text badly ragged</code>	<code>text badly centered</code>	<code>align=center</code>	<code>align=flush center</code>
<code>align=justify</code>	<code>align=flush right</code>	<code>align=right</code>	<code>align=flush left</code>

	<code>\tikz \node [draw] { \begin{tabular}{ c c } \hline AAA &amp; BBB \\ \hline CCC &amp; DDD \\ \hline \end{tabular} };</code>
--	--

<code>\tikz[align=left] \node[draw] {AAA \ \ BBBBBBBB \ \ CC};</code>		
<code>[align=left]</code>	<code>[align=center]</code>	<code>[align=right]</code>



<code>\tikz[align=left] \node[draw] {AAA \ \ [1cm] BBBBBBBB };</code>	
<code>[1cm]</code>	<code>[-1cm]</code>

### 17.8.2 Couleur et fontes

<b>Texte.</b>	<i>Texte.</i>	<i>Texte.</i>	Texte.	Texte.	Texte.
<code>[text= red]</code>	<code>[font=\itshape]</code>	<code>[font=\slshape]</code>	<code>[font=\scshape]</code>	<code>[font=\upshape]</code>	<code>[font=\bfseries]</code>

### 17.8.3 Taille des fontes

<code>\tikz \draw (0,0) node[font=\tiny]{Texte.}</code>						
<small>Texte.</small>	<i>Texte.</i>	<i>Texte.</i>	Texte.	Texte.	Texte.	Texte.
<code>\tiny</code>	<code>\footnotesize</code>	<code>\small</code>	<code>\large</code>	<code>\Large</code>	<code>\huge</code>	<code>\Huge</code>

PGFmanual section : 17-4-4

<code>text height=1cm</code>	<code>text depth=1cm</code>	<code>text height=0.5cm, text depth=0.5cm</code>

## 17.9 Positions prédéfinies sur un nœud

### 17.9.1 pour l'ensemble des nœuds

PGFmanual section : 17-5-1

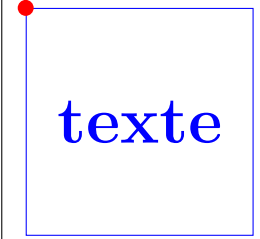
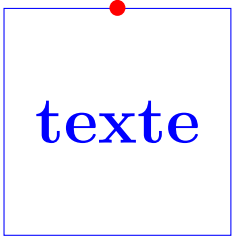
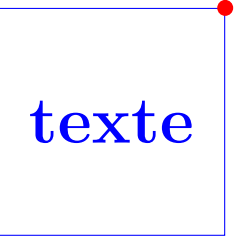
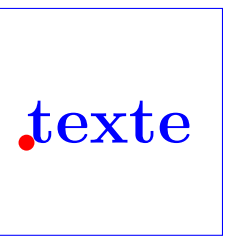
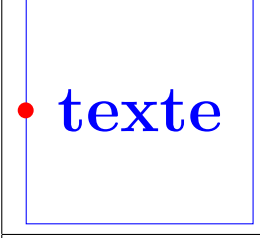
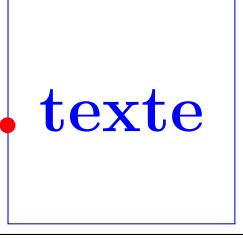
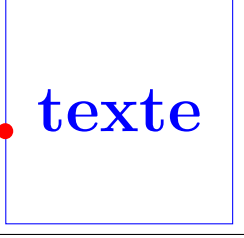
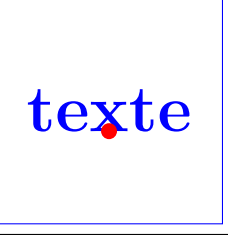
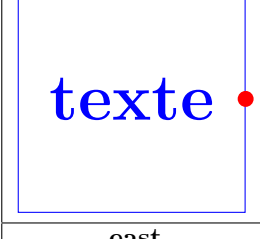
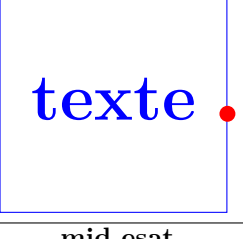
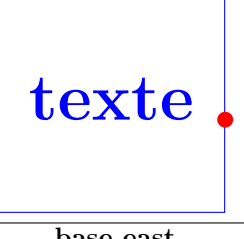
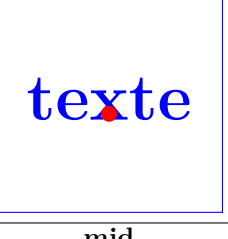
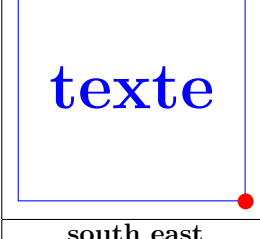
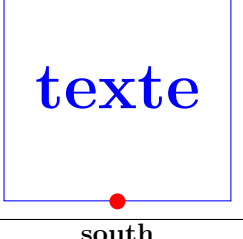
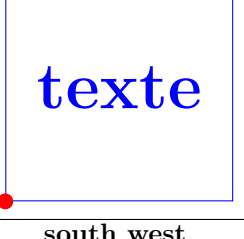
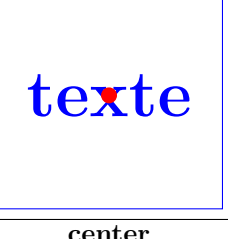
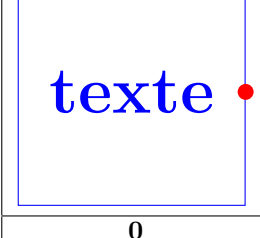
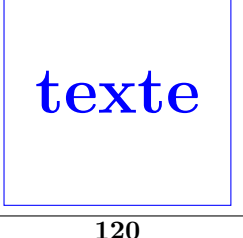
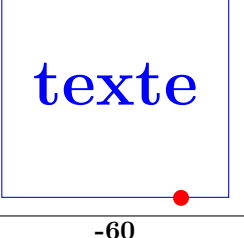
			
north west	north	north east	text
			
west	mid west	base west	base
			
east	mid esat	base east	mid
			
south east	south	south west	center
			
0	120	-60	

17.9.2 spécifique à un nœud

Consultez [PGFmanual section : 67](#)

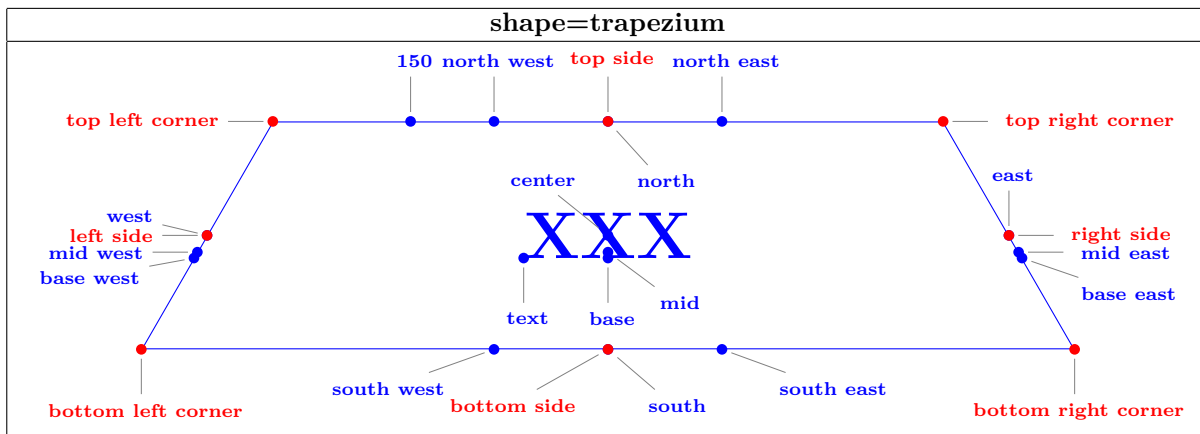
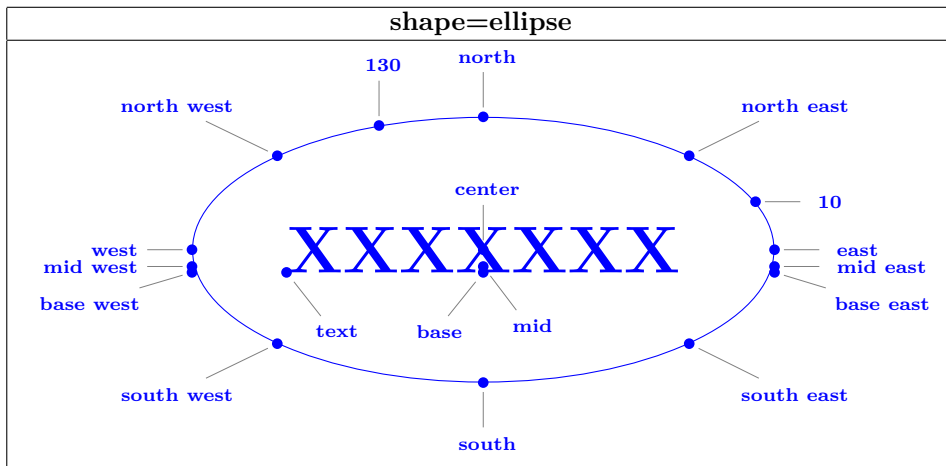
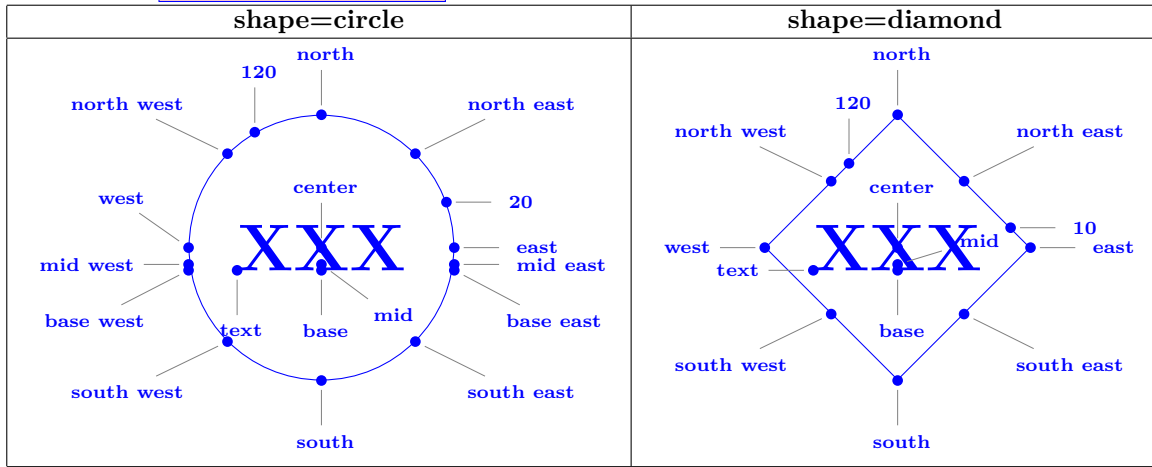

shape=semicircle,shape border rotate=0

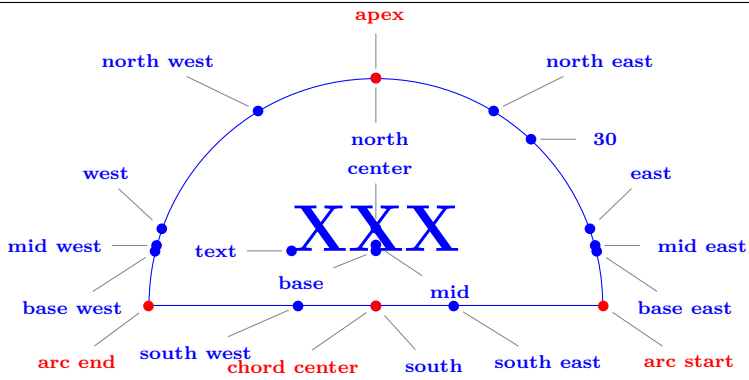

shape=regular polygon

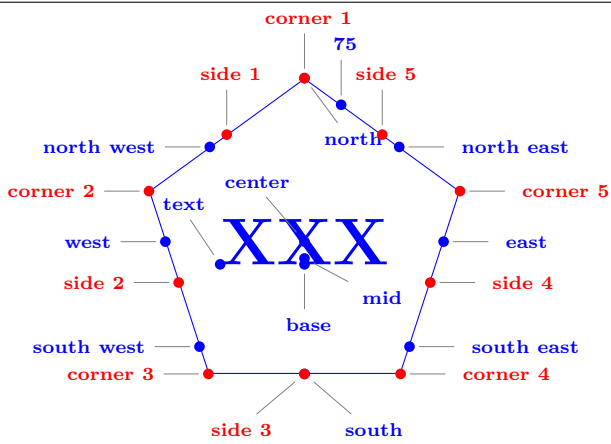

shape=star

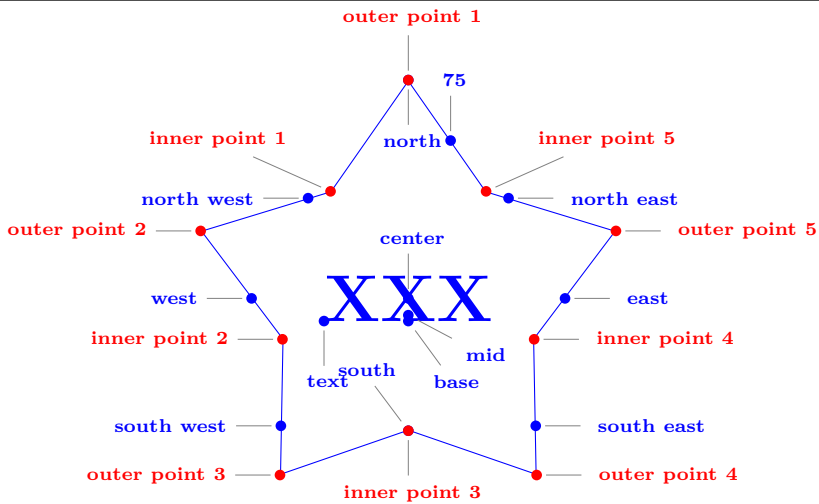

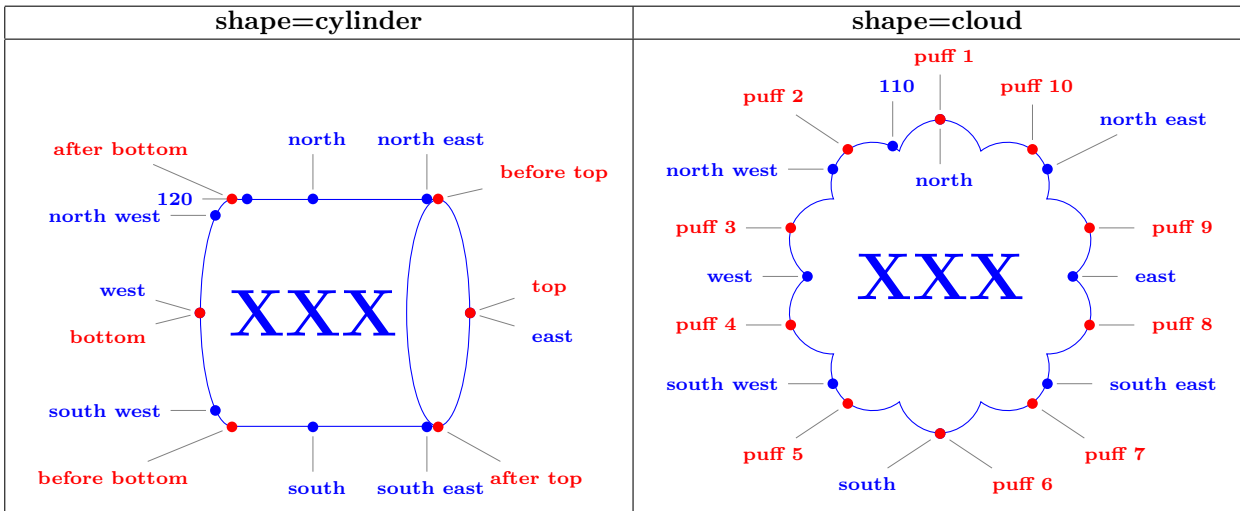
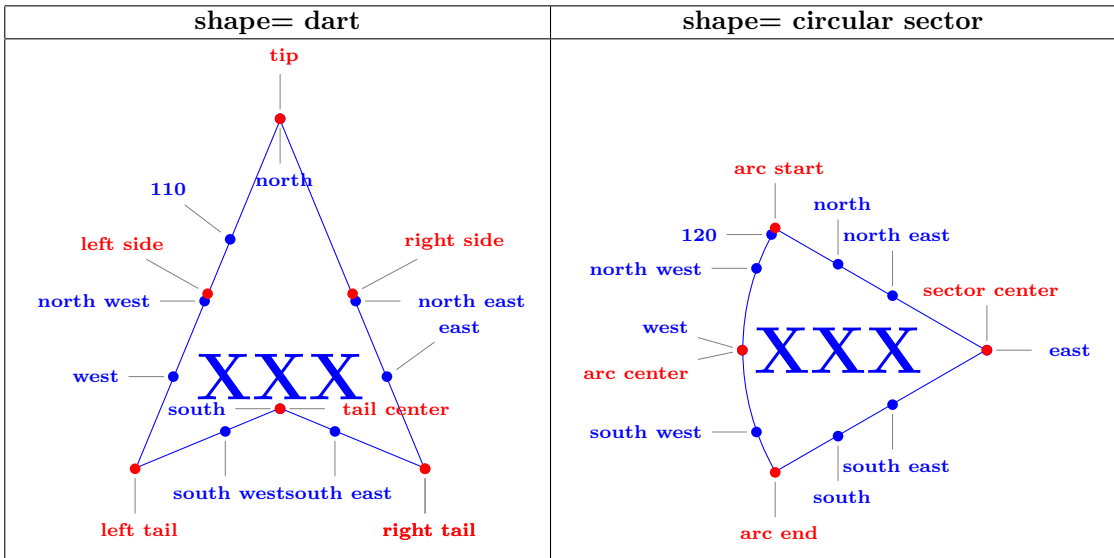
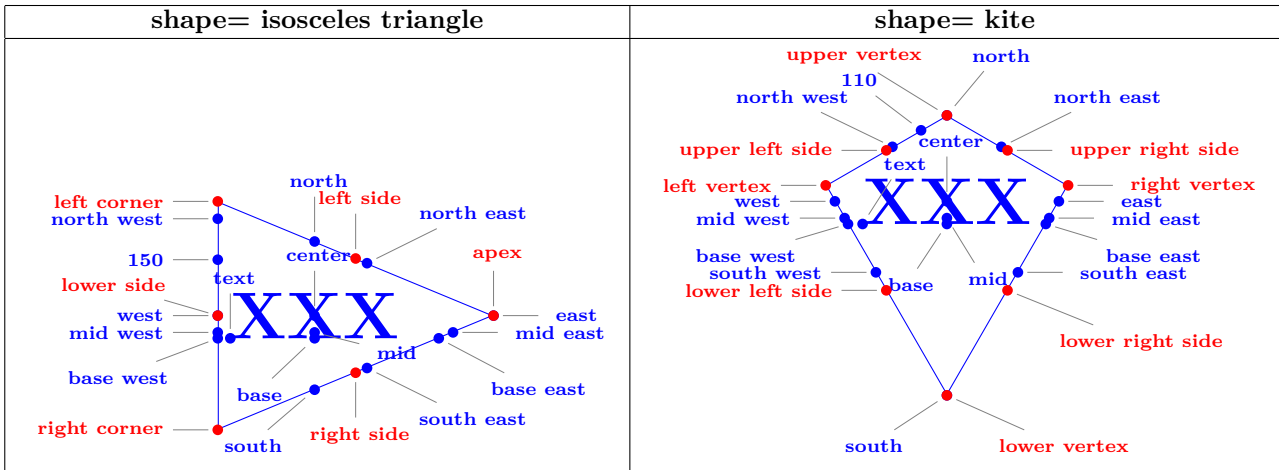

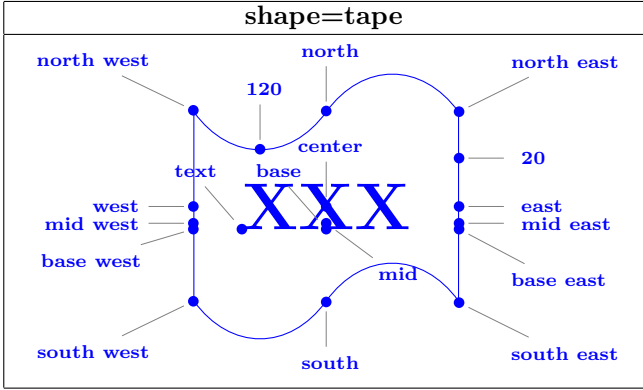
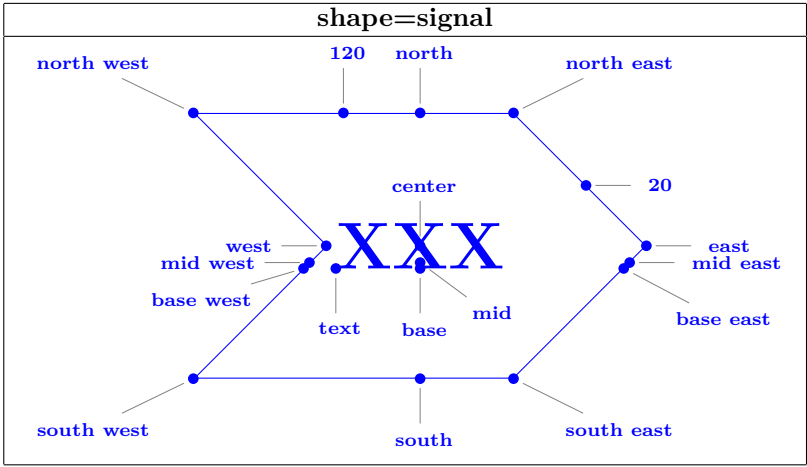
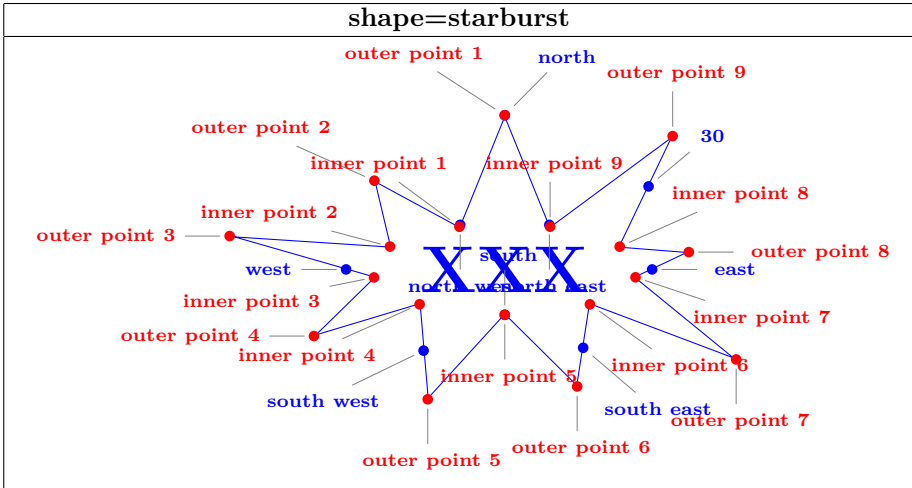

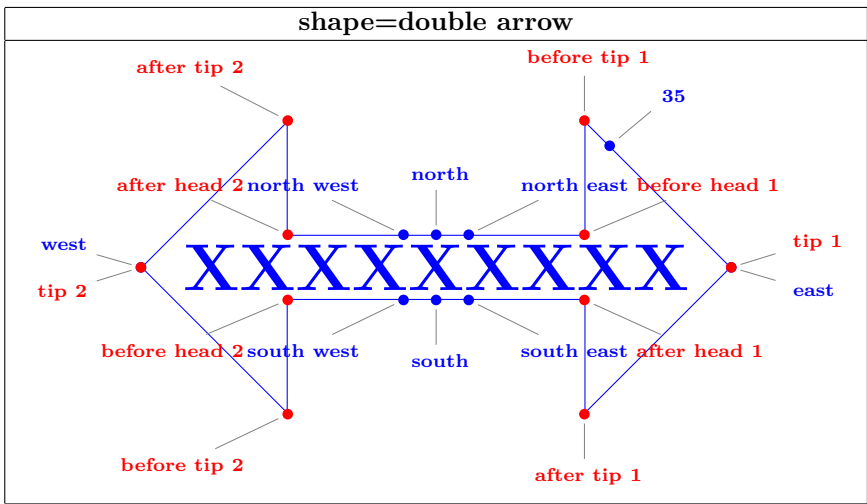
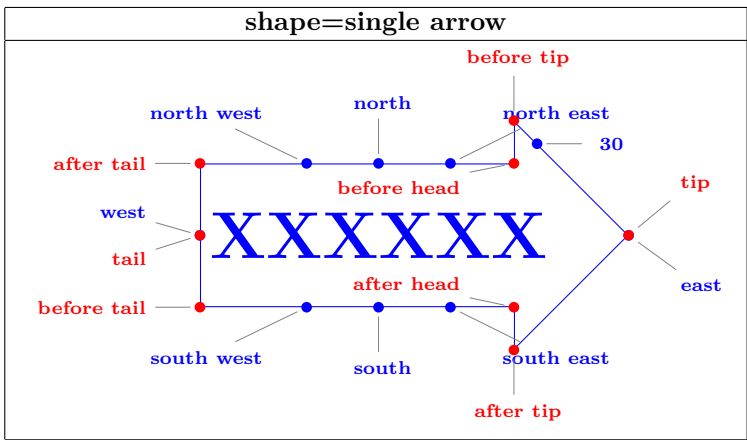
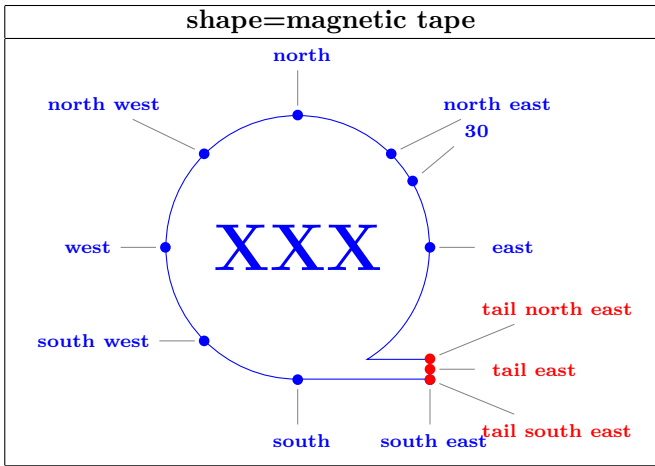

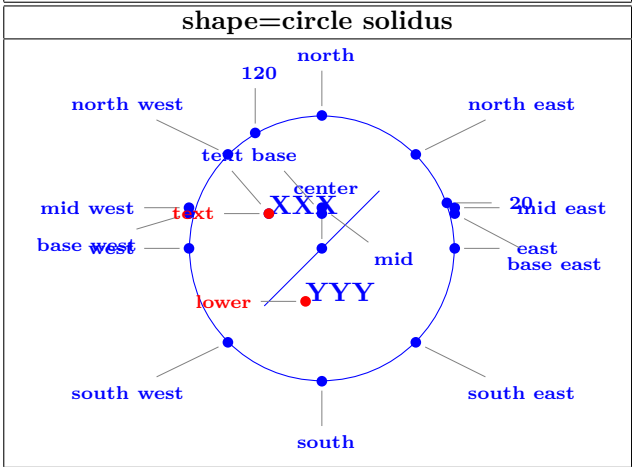
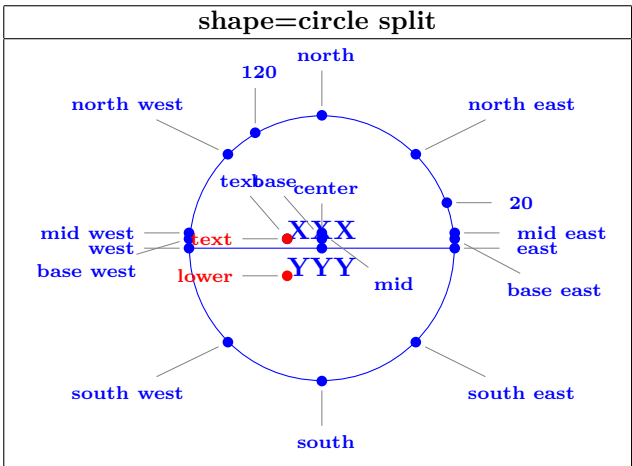
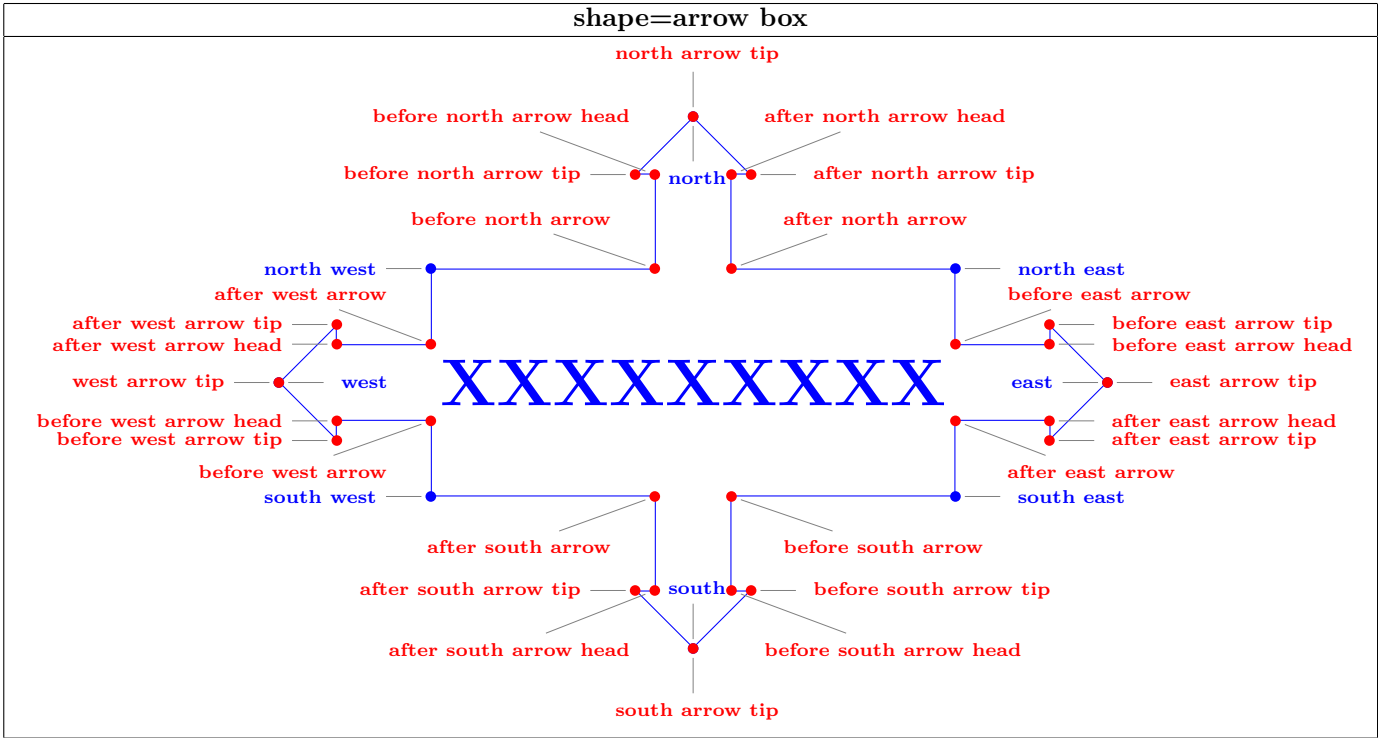



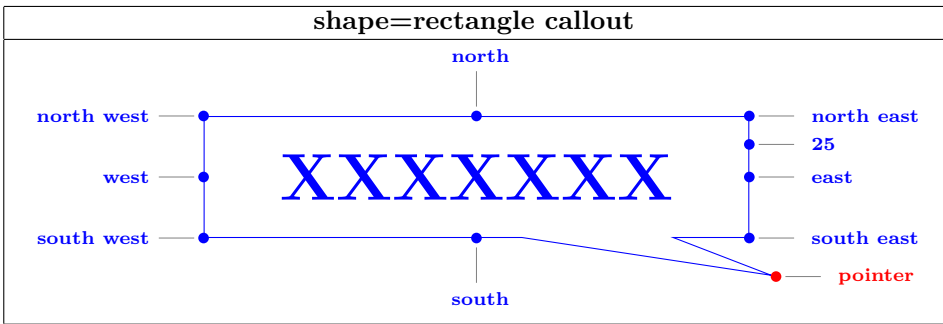
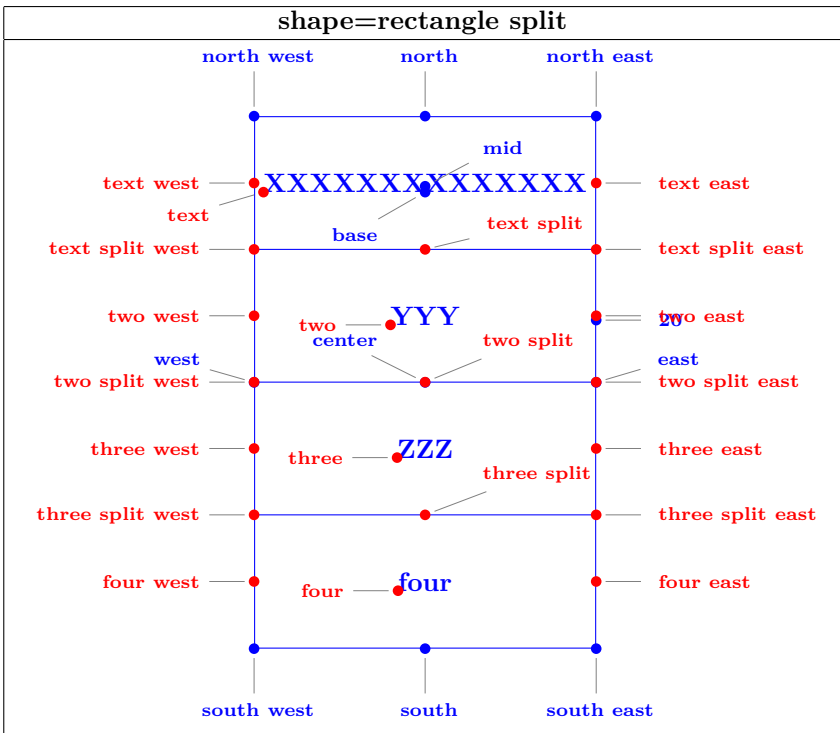
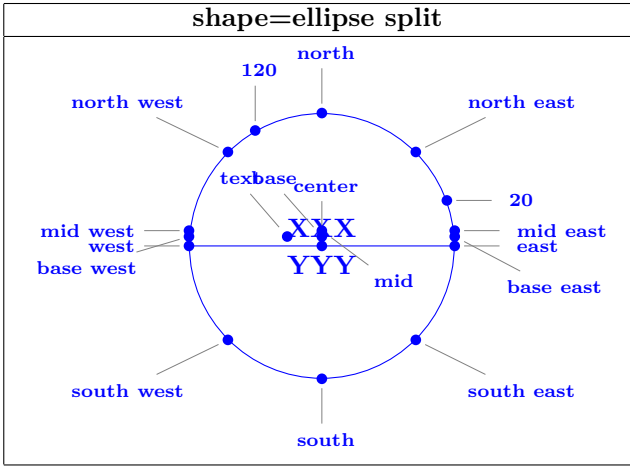

shape=ellipse callout

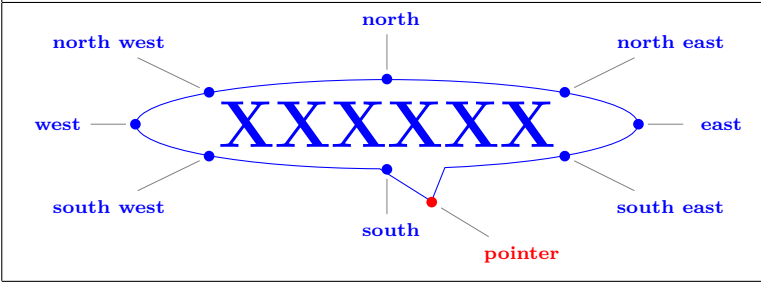

shape=cloud callout

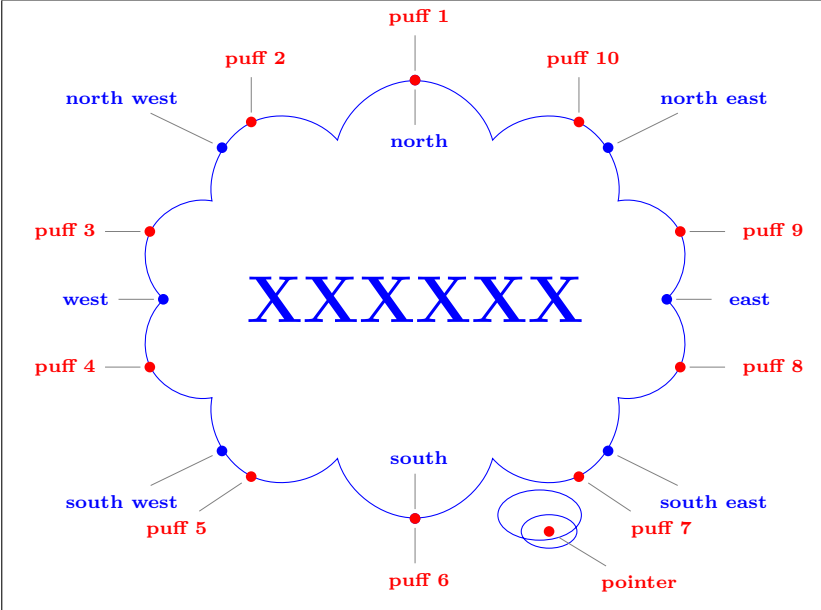

shape=cross out

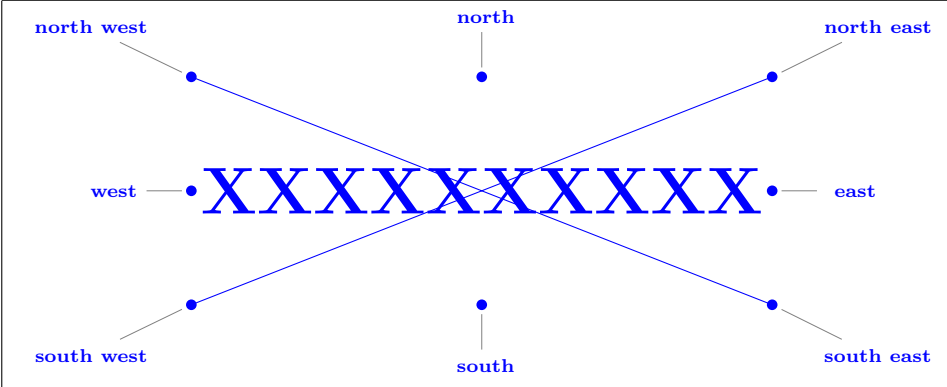

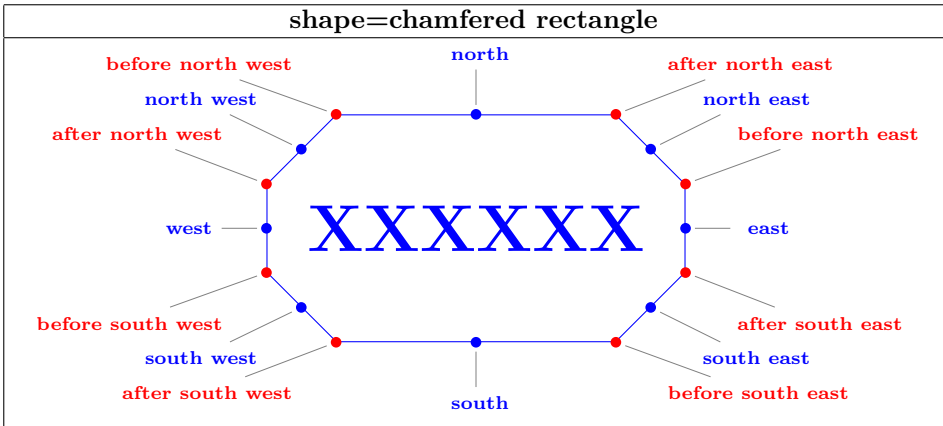
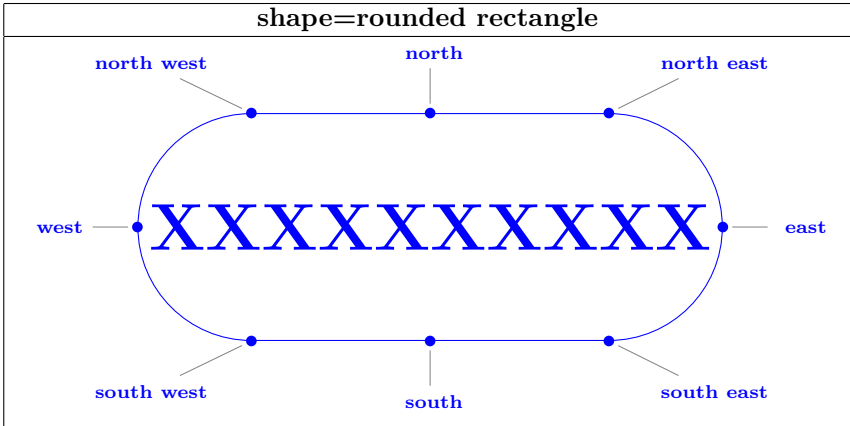

## 18 Decorations

### 18.1 Library “decorations.pathmorphing”

PGFmanual section : 48-2

#### 18.1.1 “lineto”

(0,0) - - (2,2)	(1,1) circle (1)	(0,0) arc (0:180:3 and 2)

#### 18.1.2 “straight zigzag”

<code>\draw[decorate,decoration=straight zigzag ] (0,0) - - (2,2) ;</code>		
(0,0) - - (2,2)	(1,1) circle (1)	(0,0) arc (0:180:3 and 2);

<code>\draw[decorate,decoration={straight zigzag,meta-segment length=2cm}] (0,0) - - (10,0);</code>	Par défaut :
<code>meta-segment length=2cm</code>	1cm
<code>amplitude=0.5cm</code>	2.5pt
<code>segment length=1cm</code>	10pt

<code>\draw[decorate,decoration={straight zigzag,meta-segment length=0.5cm}] (1,1) circle (1);</code>		
<code>meta-segment length=2cm</code>	<code>amplitude=0.5cm</code>	<code>segment length=5pt</code>

#### 18.1.3 “random steps”

<code>\draw[decorate,decoration=random steps ] (0,0) - - (2,2) ;</code>		
(0,0) - (2,2)	(1,1) circle (1)	(0,0) arc (0:180:3 and 2)

<code>\draw[decorate,decoration={random steps,segment length=2cm}] (0,0) - - (10,0);</code>		Par défaut :
<code>segment length=2pt</code>		10pt
<code>segment length=1cm</code>		
<code>amplitude=0.5cm</code>		2.5pt
<code>amplitude=0.5cm</code> <code>,segment length=1cm</code>		

<code>\draw[decorate,decoration={random steps,segment length=2cm}] (1,1) circle (1);</code>		
<code>meta-segment length=2cm</code>	<code>amplitude=0.5cm</code>	<code>segment length=5pt</code>

#### 18.1.4 “saw”

<code>\draw[decorate,decoration=saw] (0,0) - - (2,2) ;</code>		
<code>(0,0) - - (2,2)</code>	<code>(1,1) circle (1)</code>	<code>(0,0) arc (0:180:3 and 2);</code>

<code>\draw[decorate,decoration={saw,meta-segment length=0.5cm}] (0,0) - - (10,0);</code>		Par défaut :
<code>segment length=0.5cm</code>		10 pt
<code>segment length=2cm</code>		
<code>amplitude=0.5cm</code>		2.5 pt

<code>\draw[decorate,decoration={saw,segment length=20pt}] (1,1) circle (1);</code>		
<code>segment length=20pt</code>	<code>segment length=5pt</code>	<code>amplitude=0.5cm</code>

18.1.5 “zigzag”

<code>\draw[decorate,decoration=zigzag] (0,0) -- (2,2);</code>		
<code>(0,0) -- (2,2)</code>	<code>(1,1) circle (1)</code>	<code>(0,0) arc (0:180:3 and 2);</code>

<code>\draw[decorate,decoration={zigzag,meta-segment length=2cm}] (0,0) -- (10,0);</code>		Par défaut :
<code>segment length=0.5cm</code>		10pt
<code>segment length=2cm</code>		
<code>amplitude=0.5cm</code>		2.5 pt

<code>\draw[decorate,decoration={saw,segment length=20pt}] (1,1) circle (1);</code>		
<code>segment length=20pt</code>	<code>segment length=5pt</code>	<code>amplitude=0.5cm</code>

18.1.6 “bent”

<code>(0,0) -- (2,2)</code>	<code>(1,1) circle (1)</code>	<code>(0,0) arc (0:180:3 and 2);</code>

<code>\draw[decorate,decoration={bent,amplitude=0.5cm}] (0,0) -- (10,0);</code>		Par défaut :
<code>amplitude=0.5cm</code>		2.5 pt
<code>aspect=0.1 (en bleue)</code> <code>aspect=0.9 (en vert)</code> <code>amplitude=0.5cm</code>		0.5

<code>amplitude=1cm</code>	<code>amplitude=0.5cm</code>	<code>aspect=0.25</code>

### 18.1.7 “bumps”

<code>\draw[decorate,decoration=bumps] (0,0) - - (2,2) ;</code>		
<code>(0,0) - - (2,2)</code>	<code>(1,1) circle (1)</code>	<code>(0,0) arc (0:180:3 and 2)</code>

<code>\draw[decorate,decoration={bumps,amplitude=0.5cm}] (0,0) - - (10,0);</code>		Par défaut :
<code>amplitude=0.5cm</code>		2.5 pt
<code>segment length=1cm</code>		10 pt

<code>\draw[decorate,decoration={bumps,amplitude=10pt}] (1,1) circle (1);</code>		
<code>amplitude=10pt</code>	<code>amplitude=0.5cm</code>	<code>segment length=20pt</code>

### 18.1.8 “coil”

<code>\draw[decorate,decoration=coil] (0,0) - - (2,2) ;</code>		
<code>(0,0) - - (2,2)</code>	<code>(1,1) circle (1)</code>	<code>(0,0) arc (0:180:3 and 2)</code>

$\backslash\text{draw}[\text{decorate},\text{decoration}=\{\text{coil},\text{amplitude}=\text{0.5cm}\}] (0,0) - - (10,0);$		Par défaut :
<b>amplitude=0.5cm</b>		2.5 pt
<b>segment length=1cm</b>		10 pt
<b>aspect=0.1</b> (amplitude=0.5cm)		0.5
<b>aspect=0.3</b>		
<b>aspect=0.9</b>		

$\backslash\text{draw}[\text{decorate},\text{decoration}=\{\text{coil},\text{amplitude}=\text{0.5cm}\}] (1,1) \text{ circle } (1);$		
<b>amplitude=0.5 cm</b>	<b>segment length=1cm</b> <b>amplitude=0.5cm</b>	<b>aspect=0.25</b> <b>amplitude=0.5cm</b>

### 18.1.9 “curveto”

$(0,0) - - (2,2)$	$(1,1) \text{ circle } (1)$	$(0,0) \text{ arc } (0:180:3 \text{ and } 2)$

### 18.1.10 “snake”

$\backslash\text{draw}[\text{decorate},\text{decoration}=\text{snake}] (0,0) - - (2,2) ;$		
$(0,0) - - (2,2)$	$(1,1) \text{ circle } (1)$	$(0,0) \text{ arc } (0:180:3 \text{ and } 2)$

$\backslash\text{draw}[\text{decorate},\text{decoration}=\{\text{snake},\text{segment length}=\text{2cm}\}] (0,0) - - (10,0);$		Par défaut :
<b>amplitude=0.5cm</b>		2.5 pt
<b>segment length=1cm</b>		10 pt

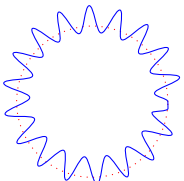
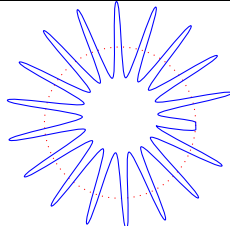
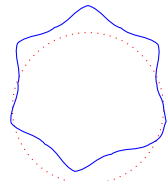

<code>\draw[decorate,decoration= snake, amplitude=5pt] (1,1) circle (1);</code>		
		
<b>amplitude=5pt</b>	<b>amplitude=0.5cm</b>	<b>segment length=5pt</b>

## 18.2 Library “decorations.pathreplacing”

Charger l'extension: `\usetikzlibrary{decorations.pathreplacing}`

PGFmanual section : 48-3

### 18.2.1 “border”

<code>\draw[decorate,decoration=border] (0,0) - - (2,2);</code>		
(0,0) - - (2,2)	(1,1) circle (1)	(0,0) arc (0:180:3 and 2)

<code>\draw[decorate,decoration={border,amplitude=0.5cm}] (0,0) - - (10,0);</code>		Par défaut :
<code>amplitude=0.5cm</code>		2.5 pt
<code>segment length=1cm , amplitude=0.5cm</code>		10 pt
<code>angle=90 , amplitude=0.5cm</code>		45

<code>\draw[decorate,decoration={border,amplitude=0.5cm}] (1,1) circle (1);</code>		
<code>amplitude=0.5cm</code>	<code>segment length=1cm ,amplitude=0.5cm</code>	<code>angle=90 ,amplitude=0.5cm</code>



### 18.2.2 “brace”

	<code>\draw [decorate,decoration=brace] (0,0) - - (3,1);</code>
--	---

<code>\draw[decorate,decoration={brace,amplitude=0.5cm}] (1,1) circle (1); ;</code>			
<code>amplitude=0.5cm</code>	<code>aspect=0.65 ,amplitude = 0.5cm</code>	<code>raise= 0.25cm ,amplitude = 0.5cm</code>	<code>mirror ,amplitude = 0.5cm</code>
Par défaut : : 2.5	Par défaut : : 0.5	Par défaut : : 0	

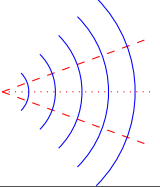
### 18.2.3 "expanding waves"

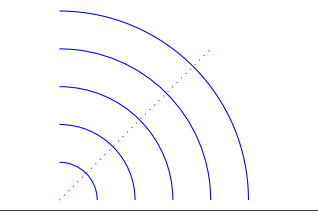
	<pre>\draw [dashed,red](0,0) -- (20:2) ; \draw [dashed,red](0,0) -- (-20:2) ; \draw [decorate,decoration={expanding waves}](0,0) -- (2,0) ;</pre>
---	---

<pre>\draw[decorate,decoration= {expanding waves,segment length=0.5cm}] (1,1) circle (1);</pre>	
	
<b>segment length=0.5cm</b> Par défaut : : 10pt	<b>angle=45</b> Par défaut : : 20

### 18.2.4 "moveto"

voir page 139

### 18.2.5 "ticks"

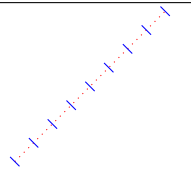
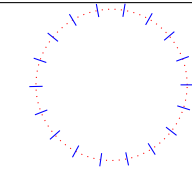
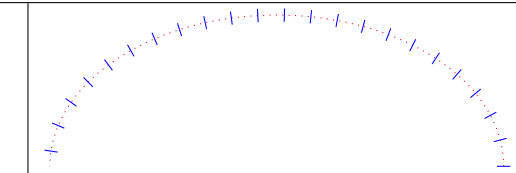
<pre>\draw[decorate,decoration=ticks] (0,0) -- (2,2) ;</pre>		
		
(0,0) -- (2,2)	(1,1) circle (1)	(0,0) arc (0:180:3 and 2)

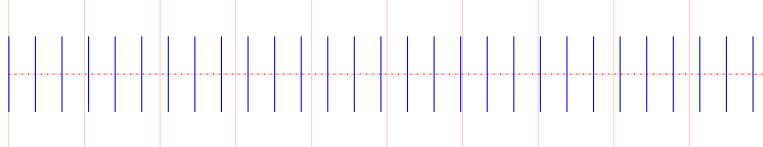
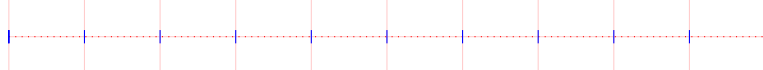
<pre>\draw[decorate,decoration={ticks,amplitude=0.5cm}] (0,0) -- (10,0);</pre>		Par défaut :
<b>amplitude=0.5cm</b>		2.5 pt
<b>segment length=1cm</b>		10 pt

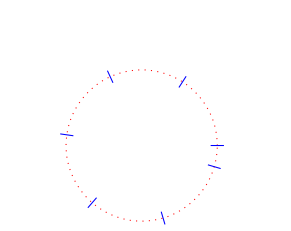
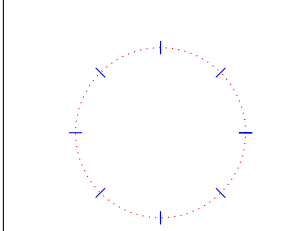
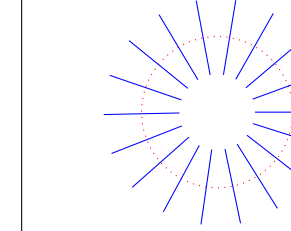
<pre>\draw[decorate,decoration= {ticks,segment length=1cm}] (1,1) circle (1);</pre>		
		
<b>segment length=1cm</b> (1,1) circle (1)	<b>segment length=pi*8</b> (1,1) circle (32pt)	<b>amplitude=0.5cm</b> (1,1) circle (1)

18.2.6 "waves"

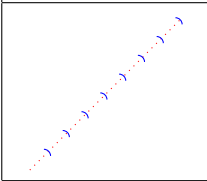
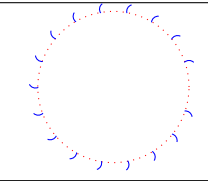
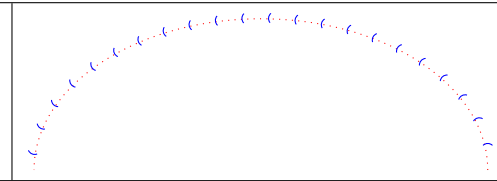
<code>\draw[decorate,decoration=waves] (0,0) - - (2,2) ;</code>		
		
(0,0) - - (2,2)	(1,1) circle (1)	(0,0) arc (0:180:3 and 2)

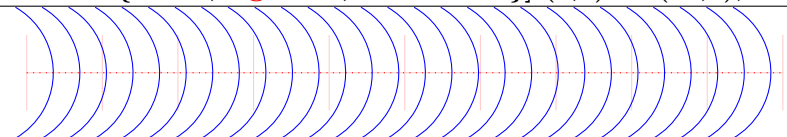
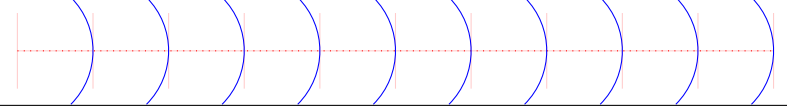
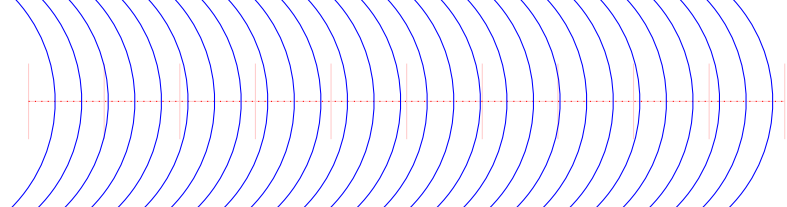
<code>\draw[decorate,decoration={waves,angle=60,radius=1cm}] (0,0) - - (10,0);</code>		Par défaut :
<code>angle=60</code>		45
<code>segment length=1cm</code>		10 pt
<code>radius=2cm</code>		10 pt

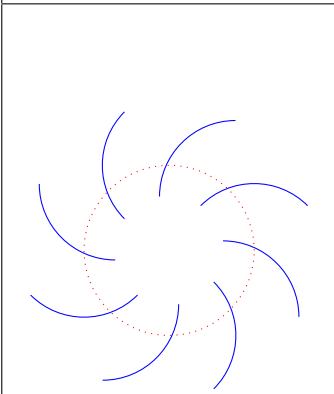
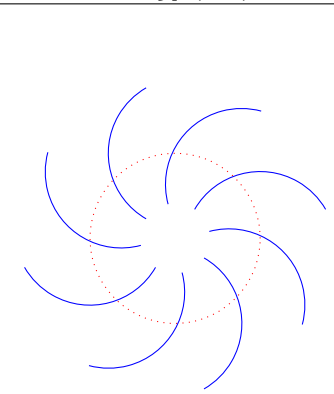
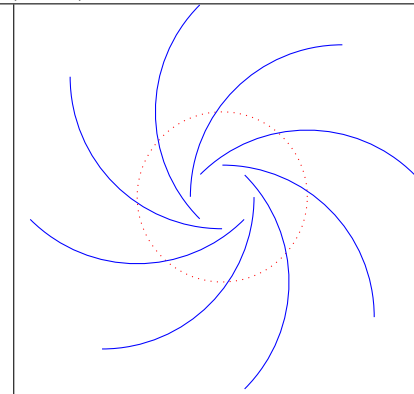
<code>\draw[decorate,decoration={waves,segment length=pi*8,radius=1cm}] (1,1) circle (32pt);</code>		
		
<code>segment length = pi*8</code>	<code>angle=60</code> <code>, segment length = pi*8</code>	<code>radius=2cm</code> <code>, segment length = pi*8</code>

### 18.2.7 “show path construction”

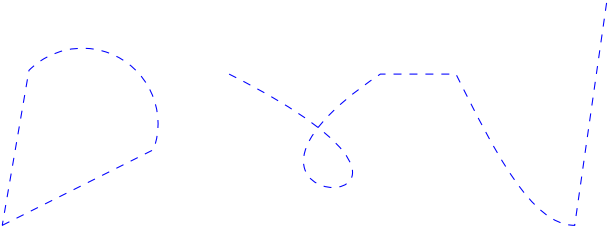
<i>Chemin à décorer</i>
<pre>\draw [blue,dashed] (0,0) -- (2,1) arc (-20:135:1) -- cycle (3,2) .. controls (7,0) and (2,0) .. (5,2) -- (6,2) sin (7.57,0) -- (8,3) ;</pre>

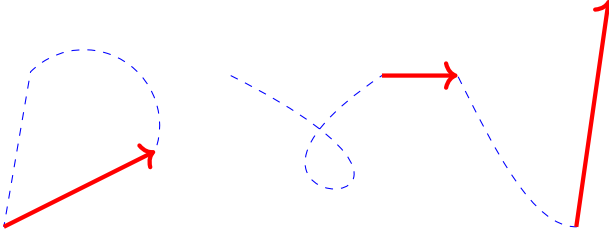
composantes linéaires : “lineto”
<pre>decoration={ show path construction, lineto code={ \draw [red,ultra thick,-&gt;] (\tikzinputsegmentfirst) -- (\tikzinputsegmentlast); },}</pre>

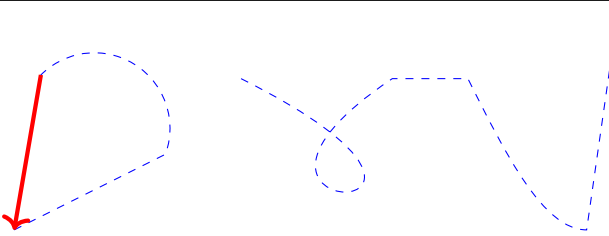
Fermetures de chemin : “closepath”
<pre>decoration={ show path construction, closepath code={ \draw [red,ultra thick,-&gt;] (\tikzinputsegmentfirst) -- (\tikzinputsegmentlast); },}</pre>

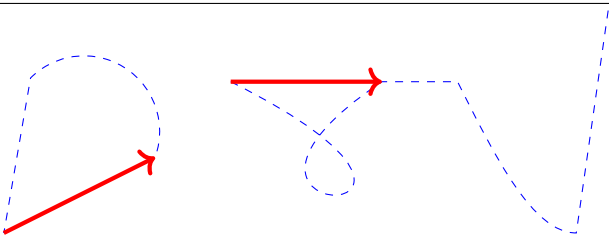
coupure de chemin : “moveto”
<pre>decoration={ show path construction, moveto code={ \draw [red,ultra thick,-&gt;] (\tikzinputsegmentfirst) -- (\tikzinputsegmentlast); },}</pre>

composants courbes : "curveto"

```
decoration={ show path construction,
curveto code={ \draw [red,ultra thick,->]
(\tikzinputsegmentfirst) -- (\tikzinputsegmentlast); },}
```

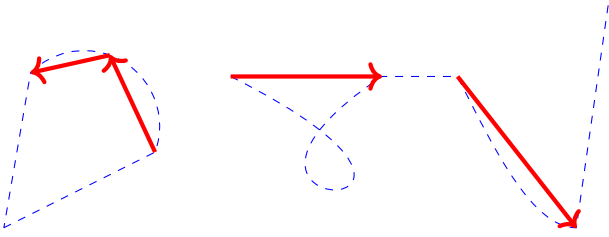

```
decoration={ show path construction,
curveto code={ \draw [red,ultra thick,->]
(\tikzinputsegmentfirst) .. (\tikzinputsegmentsupporta); },}
```

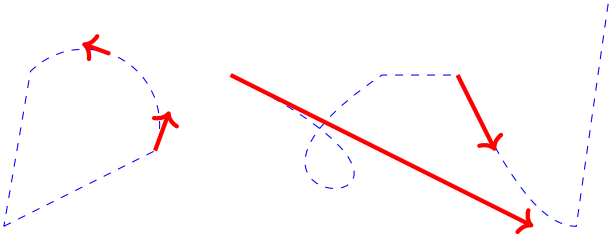

```
decoration={ show path construction,
curveto code={ \draw [red,ultra thick,->]
(\tikzinputsegmentlast) -- (\tikzinputsegmentsupportb); },}
```

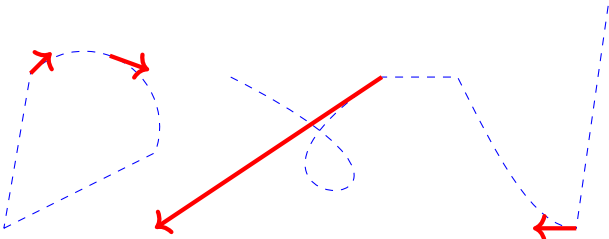

```
decoration={ show path construction,
curveto code={ \draw [red,ultra thick,->]
(\tikzinputsegmentfirst) .. controls (\tikzinputsegmentsupporta)
and (\tikzinputsegmentsupportb) .. (\tikzinputsegmentlast) ; },}
```

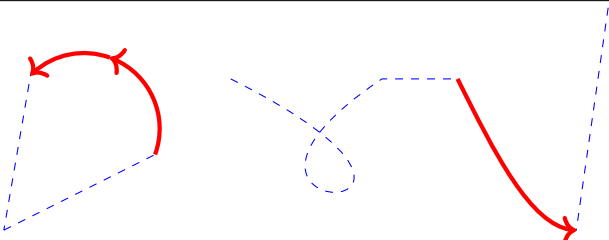

.. controls (7,0) and (2,0) .. (5,2) ne fonctionne pas !

### 18.3 Library “decorations.markings”

Charger l'extension: `\usetikzlibrary{decorations.markings}`

PGFmanual section : 48-4

#### 18.3.1 Sa marque à une position

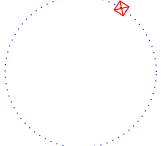
<pre>\draw [decorate,decoration={markings,mark=at position 1cm with { \draw[red] (-2pt,-2pt) - - (2pt,2pt); \draw[red](2pt,-2pt) - - (-2pt,2pt); \draw[red] (-2pt,-2pt) rectangle (2pt,2pt); }}] (1,1) circle (1);</pre>

#### 18.3.2 Ses marques : origine, fin et pas

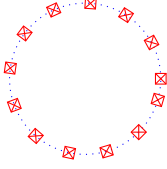
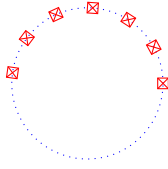
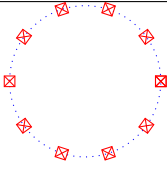
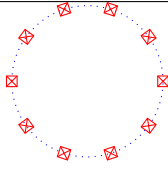
<pre>\draw[decorate,{markings,mark=between positions 0 and 1 step 5mm with ... }] (1,1) circle (1);;</pre>	
	
mark=between positions 0 and 1 step 5mm	between positions 0 and 0.5 step 5mm
	
mark= between positions 0 and 1 step 1/10	between positions 0 and 1 step0.1

#### 18.3.3 Marque avec un nœud contenant du texte

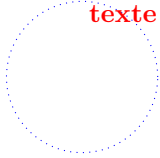
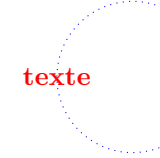
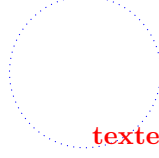
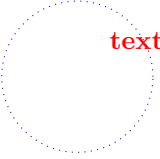
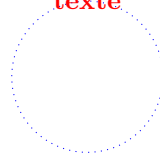
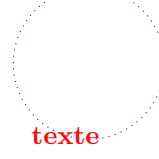
<pre>decoration={markings,mark=at position 1cm with \node[red]{texte}}</pre>		
		
at position 1cm	at position 0.5	at position -1cm
		
at position 1cm/2	at position 0.5/2	at position -0.5/2

### 18.3.4 Marque avec un nœud contenant une image

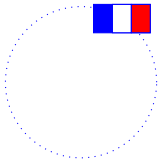
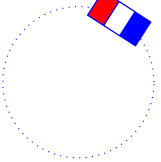
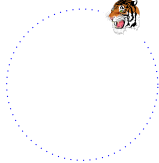
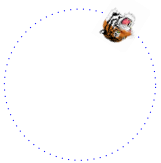
<code>\draw [decorate,decoration={markings,mark=at position 1cm with \node{\DFR};}] (1,1) circle (1);</code>	
	
<code>\node{\DFR}</code>	<code>\node[transform shape]{\DFR}</code>
	
<code>\node{\includegraphics[width=0.5cm]{tiger}}</code>	<code>\node[transform shape]{\includegraphics[width=0.5cm]{tiger}}</code>

### 18.3.5 Numérotation des marques et affectation d'un nom

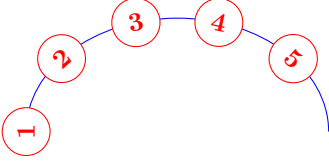
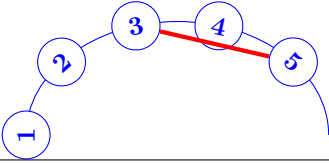
	<code>decoration={markings, mark=between positions 0 and 1 step 0.2 with { \node [draw , circle ,fill=white, name= marque-\pgfkeysvalueof{/pgf/decoration/mark info/sequence number}], transform shape] {\pgfkeysvalueof{/pgf/decoration/mark info/sequence num- ber}}};}</code>
	<code>\draw [red,ultra thick] (marque-3) - - (marque-5);</code>

### 18.3.6 Distance des nœuds



<code>decoration={markings, mark=between positions 0 and 1 step 40pt with { \node [red,draw,ellipse,fill=white,font=\tiny] {\pgfkeysvalueof{/pgf/decoration/mark info/distance from start}}};}</code>

`/pgf/decoration/reset marks` (no value)

`/pgf/decoration/mark connection node=node name` (no default, initially empty)

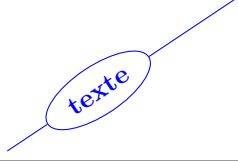

### 18.3.7 Nœud sur une liaison

	<pre>\draw [decorate,decoration={markings, mark connection node=mon noeud,mark=at position 0.4 with {\node [draw,ellipse,blue,transform shape] (mon noeud) {texte};}}] (0,0) - (3,2) ;</pre>
---	--

### 18.3.8 Arrow Tip Markings

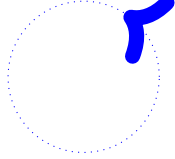
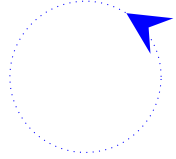
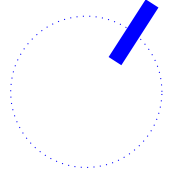
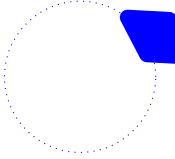
<pre>\draw[decorate,decoration={ markings,mark=at position 1cm with {\arrow[blue,line width=2mm]{&gt;}};}] (1,1) circle (1);</pre>			
			
<pre>{&gt;}</pre>	<pre>{stealth }</pre>	<pre>{ }</pre>	<pre>{diamond}</pre>
<p>Autres possibilités et paramètres voir page 21 et suivantes</p>			

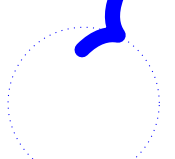
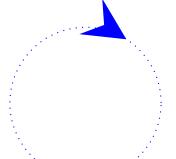
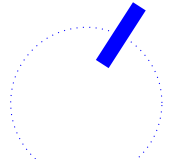
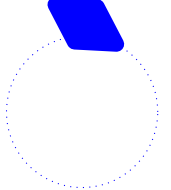
<pre>\draw[decorate,decoration={markings,mark=at position 1cm with {\arrowreversed[blue,line width=2mm]{&gt;}};}] (1,1) circle (1);</pre>			
			
<pre>{&gt;}</pre>	<pre>{stealth }</pre>	<pre>{ }</pre>	<pre>{diamond}</pre>

## 18.4 Library “decorations.footprints”

Charger l’extension: `\usetikzlibrary{decorations.footprints}`

PGFmanual section : 48-5-2

<code>\tikz \draw[decorate,decoration=footprints] (0,0) - (10,0);</code>

<code>\draw[decorate,decoration={footprints,foot of = gnome}] (0,2.5) - - (3,2.5);</code>			
foot of = <b>gnome</b>	foot of = <b>human</b> (Par défaut : )	foot of = <b>bird</b>	foot of = <b>felis silvestris</b>

<code>\fill[decorate,decoration={footprints,foot of = gnome}] (0,2.5) - - (3,2.5);</code>			
foot of = <b>gnome</b>	foot of = <b>human</b>	foot of = <b>bird</b>	foot of = <b>felis silvestris</b>

<code>\fill[decorate,decoration={footprints,foot length=20pt}] (0,2.5) - - (3,2.5);</code>	
<b>foot length=1cm</b> Par défaut : : 10pt	<b>stride length=2cm</b> Par défaut : : 30pt
<b>foot sep=1cm</b> Par défaut : : 4pt	<b>foot angle = 45</b> Par défaut : : 10

<code>\fill[decorate,decoration={footprints,foot length=20pt}] (0,2.5) - - (3,2.5);</code>			
<b>foot length=20pt</b>	<b>foot length=1cm</b>	<b>stride length=15pt</b>	<b>stride length=2cm</b>
Par défaut : : foot length=10pt		Par défaut : : stride length=30pt	
<b>foot sep=10pt</b>	<b>foot sep=1cm</b>	<b>foot angle = -45</b>	<b>foot angle = 45</b>
Par défaut : : foot sep=4pt		Par défaut : : foot angle=10	

## 18.5 Library “decorations.shapes”

### 18.5.1 Introduction

Charger l'extension: `\usetikzlibrary{decorations.shapes}`

PGFmanual section : 48-5-3

<code>\draw[decorate,decoration=crosses] (0,0) - - (3,0);</code>		
<b>crosses</b>	<b>triangles</b>	<b>shape backgrounds</b>

<code>\draw[decorate,decoration={crosses,segment length=1cm}](0,0) - - (10,0);</code>	
<b>segment length = 1cm</b>	
<b>shape width = 1cm</b>	
<b>shape height = 1cm</b>	
<b>shape size = 1cm</b>	
Par défaut : : shape width = shape height = 2.5pt	

### 18.5.2 “shape backgrounds”

<code>\draw[decorate with=dart] (0,2.5) - - (3,2.5);</code>			
<b>dart</b>	<b>diamond</b>	<b>rectangle</b>	<b>circle</b>
<b>star</b>	<b>regular polygon</b>	<b>signal</b>	<b>kite</b>
Autres possibilités et paramètres voir page 91 et suivantes			

Formes disponibles	
<i>Syntaxe</i>	<code>\draw[decorate,decoration={ shape backgrounds,shape=dart, shape size=.5cm,shape sep=1cm}] (0,0) - - (10,0);</code>
<i>Autre syntaxe</i>	<code>\draw[decorate with=dart,decoration={shape size=.5cm,shape sep=1cm}] (0,0) - - (10,0);</code>
<b>dart</b>	
<b>rectangle</b>	
<b>cloud</b>	
<b>star</b>	
<b>starburst</b>	
<b>tape</b>	
<b>kite</b>	
<b>signal</b>	
Par défaut : : shape= circle	
Autres possibilités voir page 91 et suivantes	

Paramètres			
<code>\draw[decorate with=star,star points=3,decoration={shape size=.5cm,shape sep=1cm}] (0,2.5) - - (3,2.5);</code>			
star points=3	star points=4	star points=5	star points=8
<code>\draw[decorate with=star,paint=green,decoration={shape size=.5cm,shape sep=1cm}] (0,2.5) - - (3,2.5);</code>			
paint=green	double	ultra thick	star point ratio = 3

Espacement	
<code>\draw[decorate with=dart,decoration={shape size=.5cm,shape sep=1cm}] (0,2.5) - - (10,2.5);</code>	
shape sep={1cm}	
shape sep={2cm}	
Par défaut : : shape sep= 0.25cm	

Type d'espacement	
<code>\draw[decorate with=dart,decoration={shape size=.5cm,shape sep={1cm,between centers}}] (0,2.5) - - (10,2.5);</code>	
between centers	
between borders	
Par défaut : : between centers	

Espacement automatique	
<code>\draw[decorate with=dart,decoration={shape size=.5cm,shape evenly spread=5}] (0,0) - - (10,0);</code>	
shape evenly spread=5	
shape evenly spread=10	

Orientation :

" shape border rotate "	
shape border rotate=90	
shape border rotate=45	
shape border rotate=180	

"shape sloped"	
<code>\draw[decorate with=dart,decoration={shape width=.5cm,shape sep=1cm,shape sloped=true}] (0,0) - - (3,3);</code>	
shape sloped=true	shape sloped=false
Par défaut : : shape sloped=true	

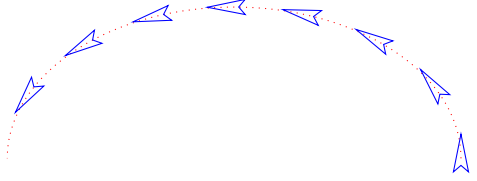
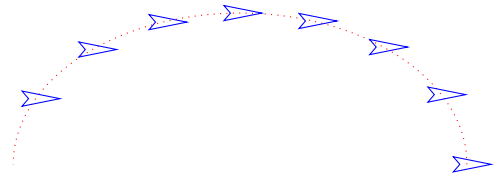
<code>\draw[decorate with=dart,decoration={shape width=.5cm,shape sep=1cm,  <b>shape sloped=true</b>}] (0,0) arc (0:180:3 and 2);</code>	
	
shape sloped=true	shape sloped=false
Par défaut : : shape sloped=true	

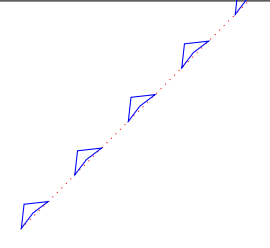
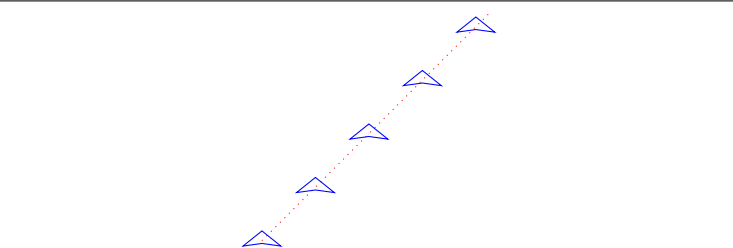
<code>\draw[decorate with=dart,decoration={shape width=.5cm,shape sep=1cm,  <b>shape border rotate=90,shape sloped=true</b> }] (0,0) - - (3,3);</code>	
	
shape sloped=true	shape sloped=false

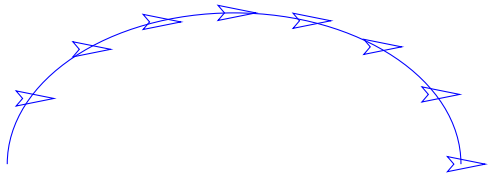
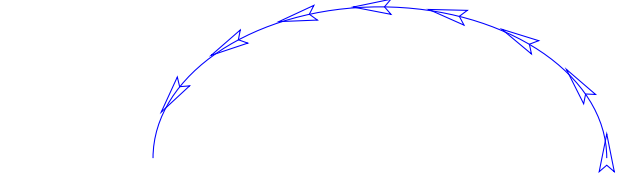
“shift only”	
decoration= <b>transform={shift only}</b> ,shape width=5mm,segment length=.5cm,shape sep=1cm	
	
avec	sans

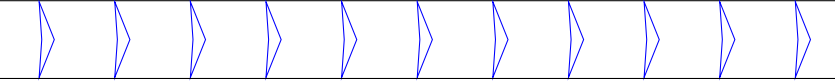
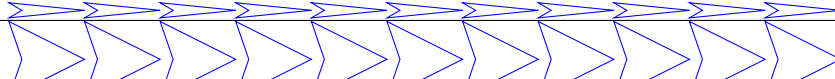
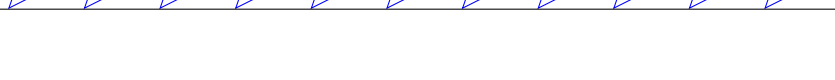
Dimensions	
<code>\draw[decorate with=dart,decoration={shape size=.5cm,  <b>shape height= 1cm</b> }] (0,0) - - (10,0);</code>	
shape height=1cm	
shape width=1cm	
shape size=1cm	

$\backslash\text{draw}[\text{decorate with}=\text{dart},\text{decoration}=\{\text{shape size}=.5\text{cm},$ $\text{shape start size}=\text{1cm},\text{shape scaled }\}\] (0,2.5) - - (10,2.5);$	
$\text{shape start size}=\text{1cm}$	
$\text{shape start height}=\text{1cm}$ $\text{shape start width}=\text{1cm}$	
$\text{shape end size}=\text{1cm}$	
$\text{shape end height}=\text{1cm}$ $\text{shape end width}=\text{1cm}$	

## 18.6 Library “decorations.text”

Charger l’extension: `\usetikzlibrary{decorations.text}`

PGFmanual section : 48-6

```
\draw[decorate,decoration={text along path,text={texte}}] (1,1) circle (1);
```

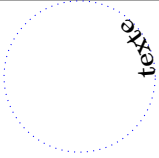

Texte trop long

```
\draw[decorate,decoration={text along path,
text={Un Deux Trois Quatre Cinq Six sept Huit Neuf Dix}}] (1,1) circle (1);
```



Format du texte

```
\draw [decorate,decoration={text along path, text=avant |\red | texte | | après }]
```

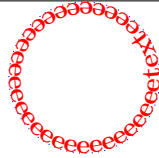
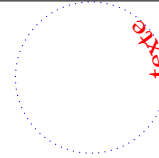
```
text={avant |\red|texte|| après }
```

```
text={ |\red|texte| }
```

```
text={ |\red|texte| { } }
```

```
avant | |\red| texte || après
```

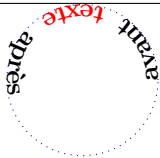
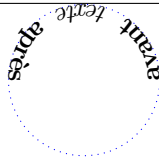
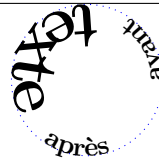
```
avant | |\it| texte || après
```

```
avant | |\Huge| texte || après
```

```
\draw [decorate,decoration={text along path,
text={avant |\Large|Visual |+\bf\color{red}|Tikz|| après }}] (1,1) circle (1);
```



```
\draw [decorate,decoration={text along path,text format delimiters={[]{}},
text={ [ |\red ] texte [ ] }}] (1,1) circle (1);
```

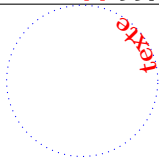

Sens du texte
<code>\draw[decorate,decoration={text along path,text={texte},text color=blue,reverse path}] (1,1) circle (1);</code>

Position du texte		
<code>\draw[decorate,decoration={text along path,text={texte},text align={align=left}}] (1,1) circle (1);</code>		
<code>align={align=left}</code>	<code>align={align=center}</code>	<code>align={align=right}</code>

<code>\draw[decorate,decoration={text along path,text={texte},text align={align=left,left indent=1cm}}] (1,1) circle (1);</code>	
<code>align={align=left,left indent=1cm}</code>	<code>align={align=right,right indent=1cm}</code>

Justification du texte	
<code>\draw [decoration={text along path, text={Un deux trois quatre },text align={fit to path}}, decorate] (1,1) circle (1);</code>	



Justification des espaces	
<code>\draw [decoration={text along path, text={Un deux trois quatre },text align={fit to path stretching spaces}}, decorate] (1,1) circle (1);</code>	





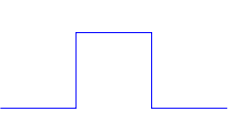
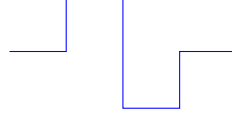
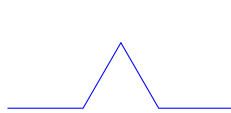

## 18.7 Library “decorations.fractals”

Charger l'extension: `\usetikzlibrary{decorations.fractals}`

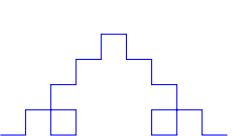
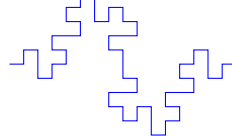
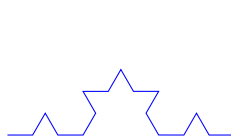
PGFmanual section : 48-7

<code>\draw[decorate,decoration=Koch curve type 1] (0,0) - - (3,0);</code>			
			
Koch curve type 1	Koch curve type 2	Koch snowflake	Cantor set

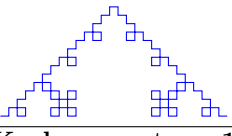
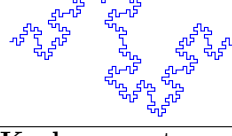
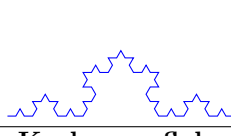
<code>\begin{tikzpicture}[decoration=Koch curve type 1] \draw decorate { decorate { (0,0) - - (3,0) } }; \end{tikzpicture}</code>			
			
Koch curve type 1	Koch curve type 2	Koch snowflake	Cantor set

<code>\draw decorate { decorate { decorate { (0,0) - - (3,0) } } };</code>			
			
Koch curve type 1	Koch curve type 2	Koch snowflake	Cantor set

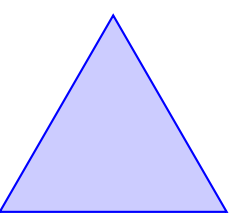
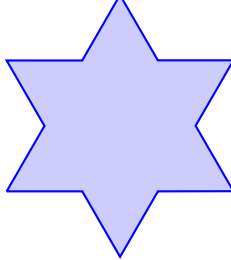
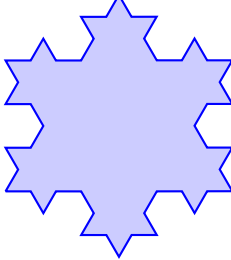
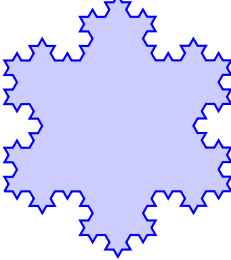
			
sans	1 decorate	2 decorate	3 decorate

## 18.8 Applications

### 18.8.1 Décoration d'un nœud

<code>\node [draw,decorate,decoration={bumps, minimum height=2cm, minimum width=3cm}] {texte};</code>	
<code>decoration=<b>bumps</b></code>	<code>decoration=<b>footprints</b></code>
<code>decoration={random steps , amplitude = 1pt }</code>	<code>starburst,decoration={random steps, segment length=3pt , amplitude=2pt}</code>
<code>ellipse,decoration=zigzag</code>	<code>decoration= {text along path,text= {Un Deux Trois Quatre Cinq Six Sept Huit Neuf} }</code>

### 18.8.2 Décoration de liaisons de noeuds

<code>\draw [decorate,decoration=snake](A) - (B);</code>		
<code>decoration=snake (A) - - (B)</code>	<code>decoration=coil (A)   - (B)</code>	<code>decoration=footprints (A) -   (B)</code>
<code>decoration=coil (A) to [bend right] (B)</code>	<code>decoration=zigzag (A) to [bend left=120] (B)</code>	<code>decoration=ticks (A) to [out=30] (B)</code>

### 18.8.3 Décoration d'un graphe

<code>\draw [decorate,decoration=footprints] plot coordinates (0,0) (2,1) (4,-2) (6,1) ;</code>	
<code>plot coordinates (0,0) (2,1) (4,-2) (6,1)</code>	<code>plot (\x,{sin(\x r)})</code>

### 18.8.4 Décorations variables

<code>\draw [decorate, decoration={zigzag,pre=footprints,pre length=5cm}](0,0) – (10,0);</code>	
<code>decoration={zigzag,pre=footprints,pre length=5cm}</code>	
<code>decoration={zigzag,post=footprints,post length=5cm}</code>	
<code>decoration={zigzag,pre=footprints,pre length=3cm, ,post=expanding waves,post length=3cm}</code>	

### 18.8.5 Décoration partielle

	<code>\draw [decorate,decoration=zigzag] (0,0) – (2,0) – (2,1) – (0,1)– cycle;</code>
	<code>\draw [decoration=zigzag] (0,0) – (2,0) decorate{– (2,1)} – (0,1)– cycle;</code>
	<code>\draw [decorate,decoration=zigzag] (0,0) – (2,0) – (2,1) – decorate{(0,1)}– cycle;</code>
	<code>\draw [decorate,decoration=zigzag] (0,0) decorate{– (2,0)} – (2,1) – decorate{(0,1)}– cycle;</code>

“lineto” \draw [decorate, decoration={zigzag,lineto,pre length=5cm}](0,0) – (10,0);
decoration={ zigzag,pre=lineto,pre length=5cm }
decoration={ zigzag,post=lineto,post length=5cm }
decoration={ zigzag,pre=lineto,pre length=3cm, ,post=curveto,post length=3cm }

“curveto”
\draw [decorate, decoration={zigzag,pre=curveto,pre length=5cm}](0,0) – (10,0);
decoration={ zigzag,pre=curveto,pre length=5cm }
decoration={ zigzag,post=curveto,post length=5cm }
decoration={ zigzag,pre=curveto,pre length=3cm, ,post=curveto,post length=3cm }

“moveto”
\draw [decorate, decoration={zigzag,pre=moveto,pre length=5cm}](0,0) – (10,0);
decoration={ zigzag,pre=moveto,pre length=5cm }
decoration={ zigzag,post=moveto,post length=5cm }
decoration={ zigzag,pre=moveto,pre length=3cm, ,post=moveto,post length=3cm }

### 18.8.6 Paramètres globaux ou particuliers

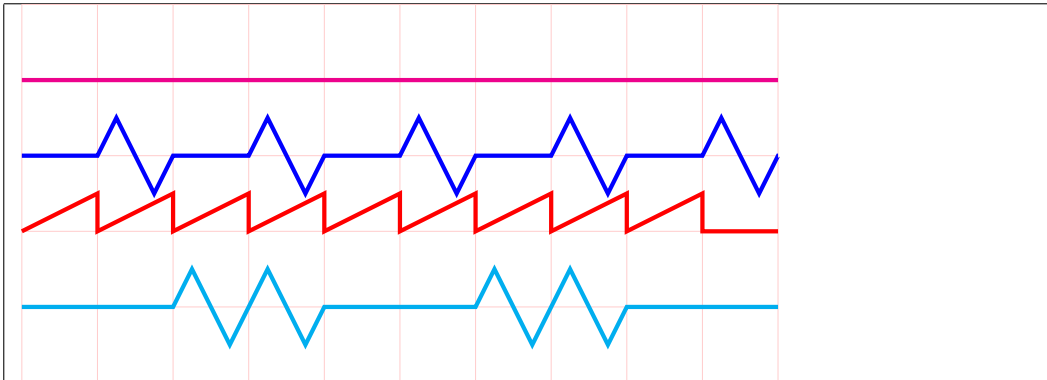

```

\begin{tikzpicture}[baseline=0pt,ultra thick,
decoration={straight zigzag,amplitude=0.5cm,segment length=1cm}]
\draw[red!20,ultra thin] (0,-2) grid (10,3);
\draw[magenta] (0,2) – (10,2);
\draw[blue,decorate] (0,1) – (10,1);
\draw[red,{decorate,decoration=saw}] (0,0) – (10,0);
\draw[cyan,decorate,decoration=meta-segment length=2cm] (0,-1) – (10,-1);
\end{tikzpicture}

```

### 18.8.7 Tracer le chemin et sa décoration avec “Postaction”

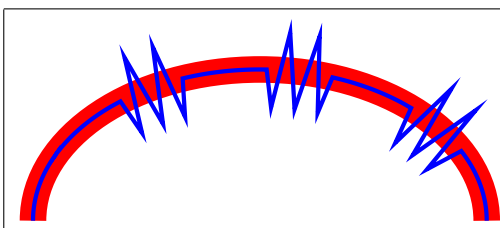

```

\draw [postaction={decorate,blue,draw,ultra
thick,
decoration={straight zigzag,ampli-
tude=0.5cm}}]
[red,line width = 10pt ] (0,0) arc (0:180:3 and
2);

```

## 19 Insertion images dans un environnement TikZ

### 19.0.1 Dans un noeud

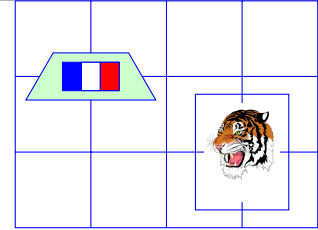
	<pre> \begin{tikzpicture} \draw (0,0) grid (5,3); \node [fill=green!20,trapezium,draw] at (1,2) {\DFR }; 88 \node [draw] at (3,1) {\includegraphics[width=1cm]{tiger} }; \end{tikzpicture} </pre>
---	---

### 19.0.2 En déclarant l'image dans pgf

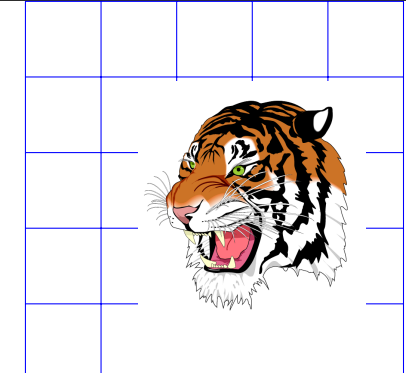
	<pre> \pgfdeclareimage[width=3cm]{ttt}{tiger}  \begin{tikzpicture} \draw (0,0) grid (5,5); \draw (3,2) node {\pgfuseimage{ttt}} ; \end{tikzpicture} </pre>
--	--

## 20 Trait à main levée

voir page 115

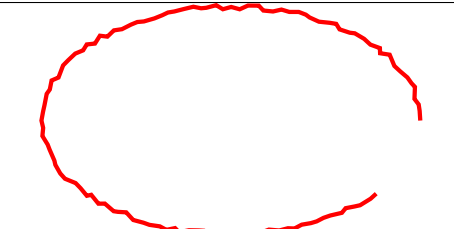
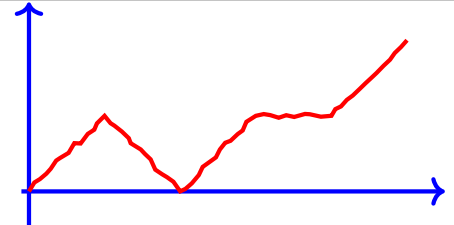
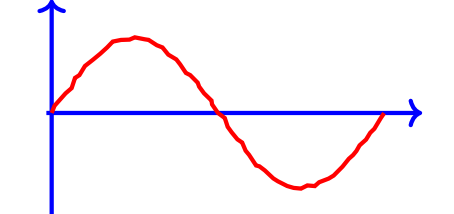
	<pre> \draw[decorate,decoration={random steps, amplitude=1pt,segment length=3pt}] (0,0) arc (0:320:2.5 and 1.5); </pre>
	<pre> \draw[decorate,decoration={random steps, amplitude=1pt,segment length=3pt}] plot coordinates (0,0) (1,1) (2,0) (3,1) (4,1) (5,2); </pre>
	<pre> \draw[decorate, decoration={random steps, amplitude=1pt,segment length=3pt}] plot (\x,\sin(\x r)); </pre>

## 21 Effets spéciaux

### 21.1 Le peuple TikZ

























Charger l'extension: `\usepackage{tikzpeople}` [4] <sup>a</sup>

<sup>a</sup> conflit `\usetikzlibrary{patterns}` page 17 : placer cette commande en premier





`\tikz \node[alice] at (0,0) ;`



#### 21.1.1 Personages disponibles

<code>\tikz \node[alice,minimum size=1.5cm] at (0,0) ;</code>						
						
alice	bob	bride	builder	businessman	charlie	chef
						
conductor	cowboy	criminal	dave	graduate	groom	guard
						
jester	judge	mexican	nun	nurse	physician	pilot
						
police	priest	sailor	santa	surgeon		





### 21.1.2 Options





<code>\tikz \node[businessman,evil,minimum size=1.5cm] at (0,0) ;</code>				
				
<b>evil</b>	<b>female</b>	<b>good</b>	<b>mirrored</b>	<b>monitor</b>





### 21.1.3 Point d'ancrage spécifique





	<pre>\begin{tikzpicture}[blue] \node[name=a,shape=bob,minimum size=1.5cm] {}; \node at (1.25,.5) [ellipse callout, draw, callout absolute pointer{(a.mouth)}, font=\tiny] Hey!; \end{tikzpicture}</pre>
---	---

### 21.1.4 Couleurs





<code>\tikz \node[alice,hair=red,minimum size=1.5cm] at (0,0) ;</code>			
			
<b>hair=red</b>	<b>skin=red</b>	<b>shirt=red</b>	<b>details=red</b>

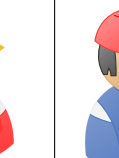



<code>\tikz \node[bob,hair=red,minimum size=1.5cm] at (0,0) ;</code>			
			
<b>hair=red</b>	<b>skin=red</b>	<b>shirt=red</b>	<b>details=red</b>



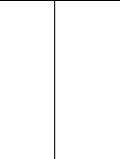

<code>\tikz \node[bride,hair=red,minimum size=1.5cm] at (0,0) ;</code>				
				
<b>hair=red</b>	<b>skin=red</b>	<b>shirt=red</b>	<b>pearls=red</b>	<b>veil=red</b>







<code>\tikz \node[builder,hair=red,minimum size=1.5cm] at (0,0) ;</code>				
				
<b>hair=red</b>	<b>skin=red</b>	<b>shirt=red</b>	<b>trousers=red</b>	<b>hat=red</b>

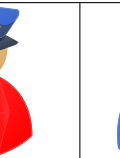

<code>\tikz \node[<b>businessman</b>,hair=red,minimum size=1.5cm] at (0,0) ;</code>					
					
<code>hair=red</code>	<code>skin=red</code>	<code>shirt=red</code>	<code>tie=red</code>	<code>undershirt=red</code>	<code>monogram=red</code>

<code>\tikz \node[<b>charlie</b>,hair=red,minimum size=1.5cm] at (0,0) ;</code>			
			
<code>hair=red</code>	<code>skin=red</code>	<code>shirt=red</code>	<code>buttons=red</code>

<code>\tikz \node[<b>chef</b>,hair=red,minimum size=1.5cm] at (0,0) ;</code>				
				
<code>hair=red</code>	<code>skin=red</code>	<code>shirt=red</code>	<code>hat=red</code>	<code>details=red</code>

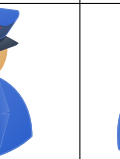
<code>\tikz \node[<b>conductor</b>,hair=red,minimum size=1.5cm] at (0,0) ;</code>				
				
<code>hair=red</code>	<code>skin=red</code>	<code>shirt=red</code>	<code>hat=red</code>	<code>hatshield=red</code>
				
<code>undershirt=red</code>	<code>shirt=red</code>	<code>hatbadge=red</code>	<code>badge=red</code>	

<code>\tikz \node[cowboy, hair=red, minimum size=1.5cm] at (0,0) ;</code>			
<code>hair=red</code>	<code>skin=red</code>	<code>shirt=green</code>	<code>hat=red</code>
<code>patches=red</code>	<code>tie=green</code>	<code>stitching=red</code>	<code>vest=red</code>

<code>\tikz \node[criminal, hat=red, minimum size=1.5cm] at (0,0) ;</code>			
<code>hat=red</code>	<code>skin=red</code>	<code>shirt=red</code>	<code>details=red</code>

<code>\tikz \node[dave, hair=red, minimum size=1.5cm] at (0,0) ;</code>				
<code>hair=red</code>	<code>skin=red</code>	<code>shirt=red</code>	<code>undershirt=green</code>	<code>tie=green</code>

<code>\tikz \node[graduate, hair=red, minimum size=1.5cm] at (0,0) ;</code>					
<code>hair=red</code>	<code>skin=red</code>	<code>shirt=red</code>	<code>undershirt=red</code>	<code>stripes=red</code>	<code>hat=red</code>

<code>\tikz \node[groom, hair=red, minimum size=1.5cm] at (0,0) ;</code>					
<code>hair=red</code>	<code>skin=red</code>	<code>shirt=red</code>	<code>undershirt=green</code>	<code>tie=green</code>	<code>hat=red</code>

\tikz \node[guard,h <sup>at</sup> =red,minimum size=1.5cm] at (0,0) ;					
hat=red	skin=red	shirt=red	collar=red	lining=red	details=red

\tikz \node[jester,h <sup>at</sup> =red,minimum size=1.5cm] at (0,0) ;					
hair=red	skin=red	shirt=yellow	hat=red	pattern=yellow <sup>2</sup>	details=blue

\tikz \node[judge,h <sup>air</sup> =red,minimum size=1.5cm] at (0,0) ;				
hair=red	skin=red	shirt=red	undershirt=red	hairshadow=red

\tikz \node[mexican,h <sup>air</sup> =red,minimum size=1.5cm] at (0,0) ;						
hair=red	skin=red	shirt=red	hat=green	ringtop=red	ringmid=red	ringbot=yellow

\tikz \node[nun,plaid=red,minimum size=1.5cm] at (0,0) ;		
plaid=red	skin=red	shirt=red

\tikz \node[nurse,h <sup>air</sup> =red,minimum size=1.5cm] at (0,0) ;						
hair=red	skin=red	shirt=red	badgeclip=green	redcross=green	badge=red	badgename=red





\tikz \node[physician, hair=red, minimum size=1.5cm] at (0,0) ;					
hair=red	skin=red	shirt=red	hat=red	stethoscope=red	tube=red



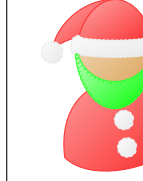

\tikz \node[pilot, hat=red, minimum size=1.5cm] at (0,0) ;						
hat=red	skin=red	shirt=red	undershirt=red	visor=red	straps=red	decoration=red

\tikz \node[police, hair=red, minimum size=1.5cm] at (0,0) ;			
hair=red	skin=red	shirt=red	hat=red
badge=red	hatbadge=red	hatshield=red	undershirt=red

\tikz \node[priest, hair=red, minimum size=1.5cm] at (0,0) ;					
hair=red	skin=red	shirt=red	hat=red	collar=red	cross=red

\tikz \node[sailor, hair=red, minimum size=1.5cm] at (0,0) ;						
hair=red	skin=red	shirt=red	hat=red	undershirt=red	stripes=red	details=red

<code>\tikz \node[santa,h<sup>at</sup>=green,minimum size=1.5cm] at (0,0) ;</code>				
				
<code>hat=green</code>	<code>skin=green</code>	<code>shirt=green</code>	<code>beard=green</code>	<code>details=green</code>

<code>\tikz \node[surgeon,h<sup>at</sup>=red,minimum size=1.5cm] at (0,0) ;</code>				
				
<code>hat=red</code>	<code>skin=red</code>	<code>shirt=red</code>	<code>hair=red</code>	<code>mask=red</code>



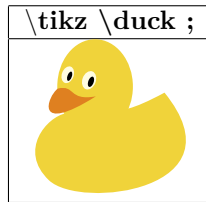

## 21.2 Ducks

Charger l'extension: `\usepackage{tikzducks}` [5]

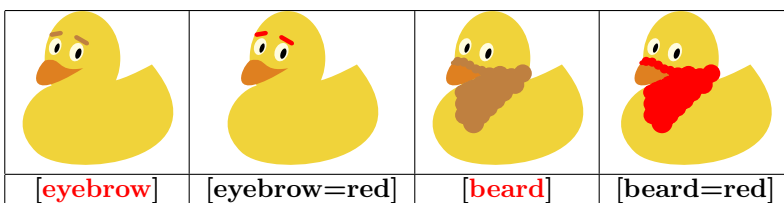
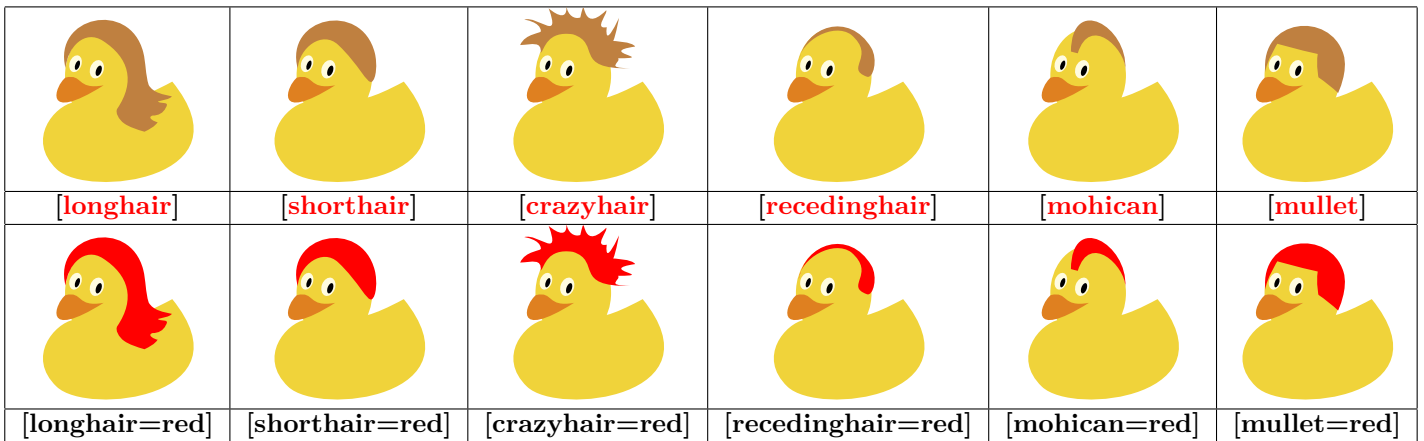
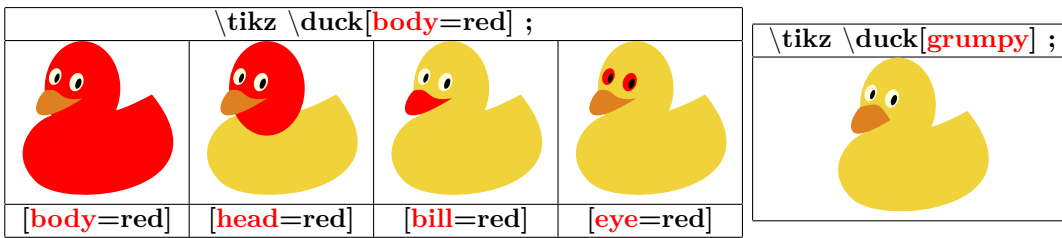

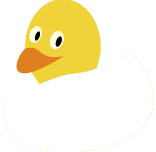
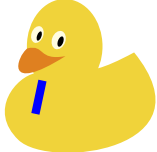
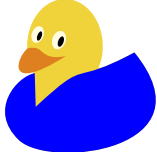

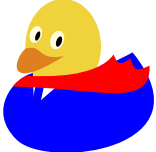
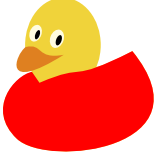
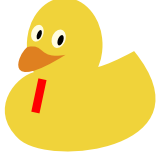

### 21.2.1 Options



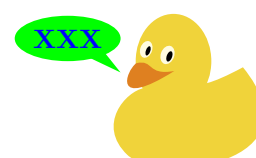
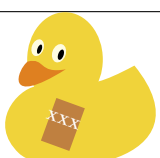
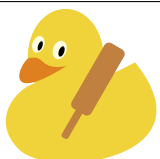

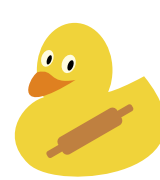
				
[tshirt]	[tie]	[jacket]	[cape]	[tshirt,tie ,jacket ,cape]
Par défaut : white	Par défaut : blue	Par défaut : blue	Par défaut : red	
				
[tshirt=red]	[tie=red]	[jacket=red]	[cape=blue]	

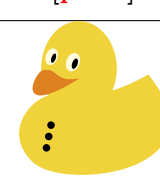
				
[water]	[alien]	[hat]	[tophat]	[cap]
				
[santa]	[graduate]	[graduate,tassel]	[beret]	[peakedcap]
				
[crown]	[queencrown]	[kingcrown]	[sheep]	[horsetail]
				
[crozier]	[unicorn]	[bunny]	[bunny=red,inear=blue]	[witch]
				
[magicwand]	[magichat]	[magichat, magicstars]	[glasses]	[sunglasses]



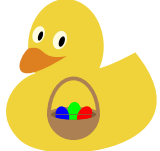

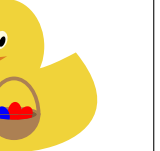
				
[squareglasses]	[signpost=42]	[signpost=XXX, signcolour=green]	[signpost=XXX, signback=green]	[speech={XXX}]
				
[speech=XXX, bubblecolour=green]	[think={XXX}]	[think=XXX, bubblecolour=green]	[book={XXX}]	
				
[book=XXX, bookcolour=green]	\tikz \duck[book= \scalebox{0.5}{XXX}]	\tikz \duck[signpost= \scalebox{0.4}{ \parbox{2cm} XXX XXXXX}]		
				
[cricket]	[hockey]	[football]	[lightsaber]	[torch]
				
[prison]	[necklace]	[icecream]	[icecream, flavoura=green]	[icecream, flavourb=green]
				
[icecream, flavourc=green]	[chef]	[rollingpin]	[cake]	[pizza]
				
[baguette]	[milkshake]	[wine]	[mask]	[buttons]



				
[basket]	[easter]	[easter, egga=red]	[easter, eggb=red]	[easter, eggc=red]

<code>\tikz \duck \path[preaction={fill,green},pattern=dots, pattern color=red] \duckpathbody ;</code>			
			
<code>\duckpathbody</code>	<code>\duckpathgrumpybill</code>	<code>\duckpathbill</code>	<code>\duckpathtshirt</code>
			
<code>\duckpathjacket</code>	<code>\duckpathcape</code>	<code>\duckpathshorthair</code>	<code>\duckpathlonghair</code>
			
<code>\duckpathcrazyhair</code>	<code>\duckpathrecedinghair</code>	<code>\duckpathcrown</code>	<code>\duckpathmohican</code>
			
<code>\duckpathmullet</code>	<code>\duckpathqueen crown</code>	<code>\duckpathking crown</code>	<code>\duckpathdarthvader</code>
			
<code>\duckpathhorsetail</code>			

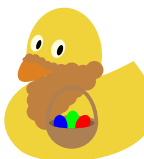
21.2.2 Canards aléatoires

<code>\tikz \randuck ; \tikz \randuck ; \tikz \randuck ; \tikz \randuck ; \tikz \randuck ;</code>				
				

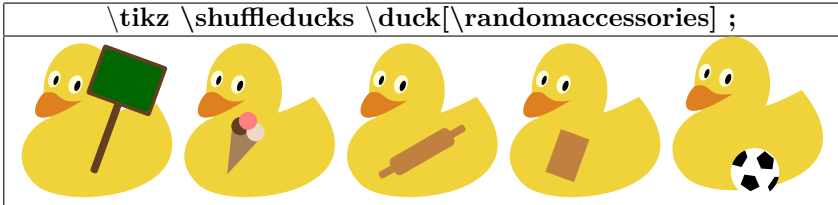
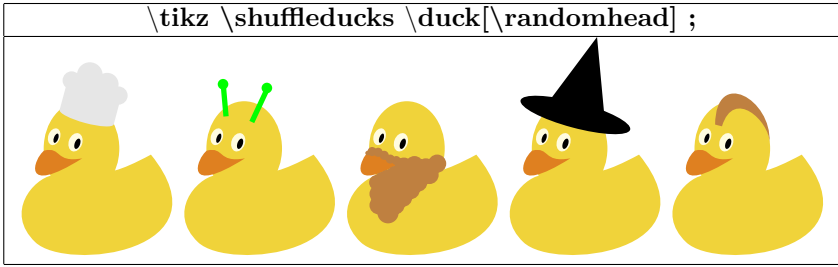



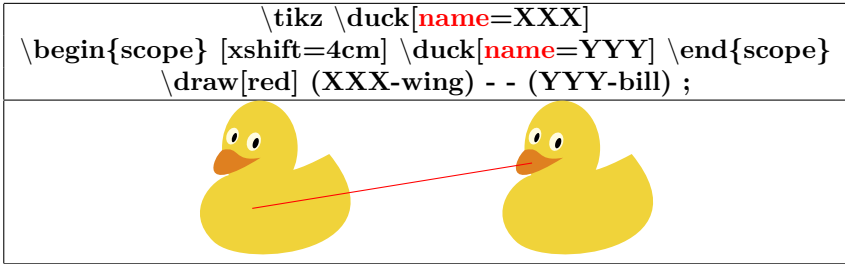
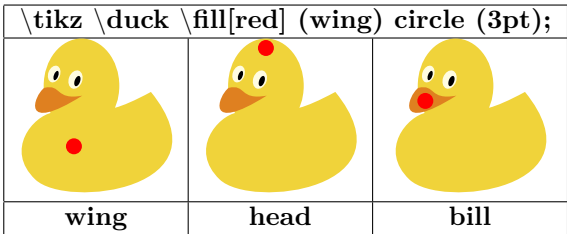

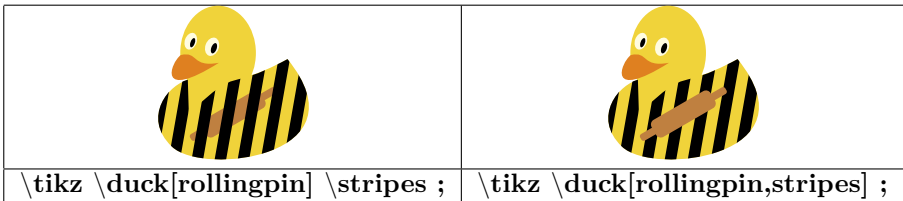
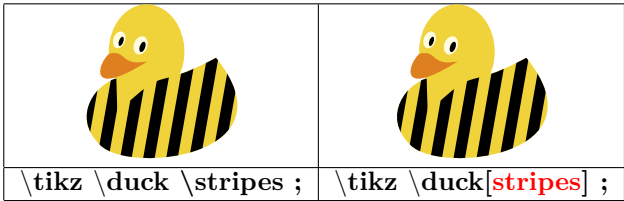

21.2.3 Coordonnées



21.2.4 Rayures

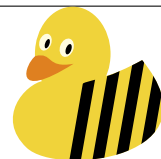
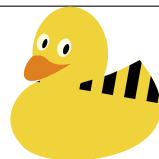

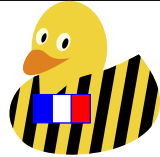

<code>\tikz \[duck] \stripes[<b>color=red</b>];</code>			
			
<code>[<b>color=red</b>]</code>	<code>[<b>distance=.5</b>]</code>	<code>[<b>width=.05</b>]</code>	<code>[<b>height=1</b>]</code>
Par défaut : black	Par défaut : 0.3	Par défaut : 0.15	Par défaut : 2.7
			
<code>[<b>rotate=45</b>]</code>	<code>[<b>initialx=1</b>]</code>	<code>[<b>initialy=1</b>]</code>	
Par défaut : -10	Par défaut : 0.1	Par défaut : -0.3	











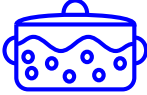

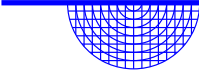





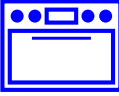

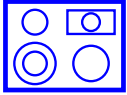

<code>\tikz \[duck] \stripes[<b>emblem=XXX</b>];</code>		
		
<code>[emblem=XXX]</code>	<code>[emblem={\includegraphics width=6mm}{LogoIUT} } ]</code>	<code>[emblem={\DFR} ]</code>
		<code>\DFR : voir page 88</code>

<code>\tikz \duck[stripes={ \stripes \stripes[rotate=45] } ] ;</code>

### 21.3 symbol

Charger l'extension: `\usepackage{tikzsymbols}` [6]

		
<code>\Smiley</code>	<code>\Smiley[3]</code>	<code>\Smiley[5][green]</code>

				
	<code>\Kochtopf[5]</code>	<code>\Bratpfanne[5]</code>	<code>\Schneebeesen[5]</code>	<code>\Sieb[5]</code>
	<code>\pot[5]</code>	<code>\fryingpan[5]</code>	<code>\eggbeater[5]</code>	<code>\sieve[5]</code>
				
	<code>\Purierstab[5]</code>	<code>\Dreizack[5]</code>	<code>\Backblech[5]</code>	<code>\Ofen[5]</code>
	<code>\blender[5]</code>	<code>\trident[5]</code>	<code>\bakingplate[5]</code>	<code>\oven[5]</code>
				
	<code>\Pfanne[5]</code>	<code>\Herd[5]</code>	<code>\Saftpresse[5]</code>	<code>\Schussel[5]</code>
	<code>\pan[5]</code>	<code>\cooker[5]</code>	<code>\squeezer[5]</code>	<code>\bowl[5]</code>
				
	<code>\Schaler[5]</code>	<code>\Reibe[5]</code>	<code>\Flasche[5]</code>	<code>\Nudelholz[5]</code>
	<code>\peeler[5]</code>	<code>\grater[5]</code>	<code>\bottle[5]</code>	<code>\rollingpin[5]</code>



<code>\Smiley[5]</code>	<code>\Sadey[5]</code>	<code>\Neutrey[5]</code>	<code>\Changey[5]{0}</code>	<code>\cChangey[5]{0}</code>
<code>\Annoey[5]</code>	<code>\Laughey[5]</code>	<code>\Winkey[5]</code>	<code>\oldWinkey[5]</code>	<code>\Sey[5]</code>
<code>\Xey[5]</code>	<code>\Innocey[5]</code>	<code>\wInnocey[5]</code>	<code>\Cooley[5]</code>	<code>\Tongey[5]</code>
<code>\Nursey[5]</code>	<code>\Vomey[5]</code>	<code>\Walley[5]</code> <code>\rWalley[5]</code>	<code>\Cat[5]</code>	
<code>\SchrodingersCat[5]{0}</code>	<code>\Ninja[5]</code>	<code>\Sleepy[5]</code>	<code>\NiceReapey[5]</code>	





















<code>\Changey[5]{-2}</code>	<code>\Changey[5]{-1}</code>	<code>\Changey[5]{0}</code>	<code>\Changey[5]{1}</code>	<code>\Changey[5]{2}</code>



<code>\cChangey[5]{-2}</code>	<code>\cChangey[5]{-1}</code>	<code>\cChangey[5]{0}</code>	<code>\cChangey[5]{1}</code>	<code>\cChangey[5]{2}</code>





<code>\SchrodingersCat[5]{-1}</code>	<code>\SchrodingersCat[5]{0}</code>	<code>\SchrodingersCat[5]{1}</code>







<code>\Laughey[5][green][red]</code>	<code>\Innocey[5][green][red]</code>	<code>\Tongey[5][green][red]</code>	<code>\Nursey[5][green][red]</code>
<code>\Vomey[5][green][red]</code>	<code>\Walley[5][green][red]</code>	<code>\rWalley[5][green][red]</code>	



	
<code>\dNinja[5][green][red][blue]</code>	<code>\dSleepy[5][green][red][blue]</code>







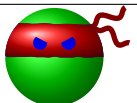

				
<code>\dSmiley[5]</code>	<code>\dSadey[5]</code>	<code>\dNeutrey[5]</code>	<code>\dChangey[5]{0}</code>	<code>\dcChangey[5]{0}</code>
				
<code>\dAnnoey[5]</code>	<code>\dLaughey[5]</code>	<code>\dWinkey[5]</code>	<code>\dSey[5]</code>	<code>\dXey[5]</code>
				
<code>\dInnocey[5]</code>	<code>\dCooley[5]</code>	<code>\dNinja[5]</code>	<code>\drWalley[5]</code>	<code>\dWalley[5]</code>
				
<code>\dVomey[5]</code>	<code>\dNursey[5]</code>	<code>\dTongey[5]</code>	<code>\dSleepy[5]</code>	<code>\olddWinkey[5]</code>





				
<code>\dChangey[5]{-2}</code>	<code>\dChangey[5]{-1}</code>	<code>\dChangey[5]{0}</code>	<code>\dChangey[5]{1}</code>	<code>\dChangey[5]{2}</code>

				
<code>\dcChangey[5]{-2}</code>	<code>\dcChangey[5]{-1}</code>	<code>\dcChangey[5]{0}</code>	<code>\dcChangey[5]{1}</code>	<code>\dcChangey[5]{2}</code>

			
<code>\dLaughey[5][green][red]</code>	<code>\dInnocey[5][green][red]</code>	<code>\dTongey[5][green][red]</code>	<code>\dNursey[5][green][red]</code>
			
<code>\dVomey[5][green][red]</code>	<code>\dWalley[5][green][red]</code>	<code>\drWalley[5][green][red]</code>	



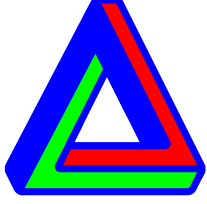

	
<code>\dNinja[5][green][red][blue]</code>	<code>\dSleepy[5][green][red][blue]</code>

				
<code>\Strichmaxerl[5]</code>	<code>\Candle[5]</code>	<code>\Fire[5]</code>	<code>\Coffeecup[5]</code>	<code>\Chair[5]</code>
				
<code>\Bed[5]</code>	<code>\Tribar[5]</code>	<code>\Moai[5]</code>	<code>\Snowman[5]</code>	

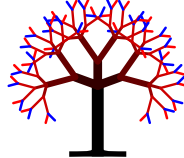
<code>\Strichmaxerl[10][0][0][0][0]</code>				
				
<code>[0][0][0][0]</code>	<code>[45][0][0][0]</code>	<code>[0][45][0][0]</code>	<code>[0][0][45][0]</code>	<code>[0][0][0][-45]</code>

<code>\Tribar[10][green][red][blue]</code>

	
<code>\BasicTree[10]{black}{red}{blue}{leaf}</code>	<code>\BasicTree[10]{black}{red}{blue}{}</code>

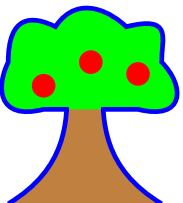
				
<code>\Springtree[10]</code>	<code>\Summertree[10]</code>	<code>\Autumntree[10]</code>	<code>\Wintertree[10]</code>	<code>\WorstTree[10]</code>

## 22 Créer un graphe

### 22.1 Graphe avec TikZ

#### 22.1.1 Graphe à partir d'une liste de points

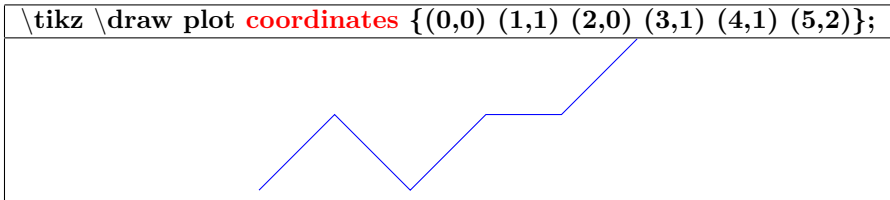

PGFmanual section : 22-2

#### 22.1.2 Graphe à partir d'un fichier de données

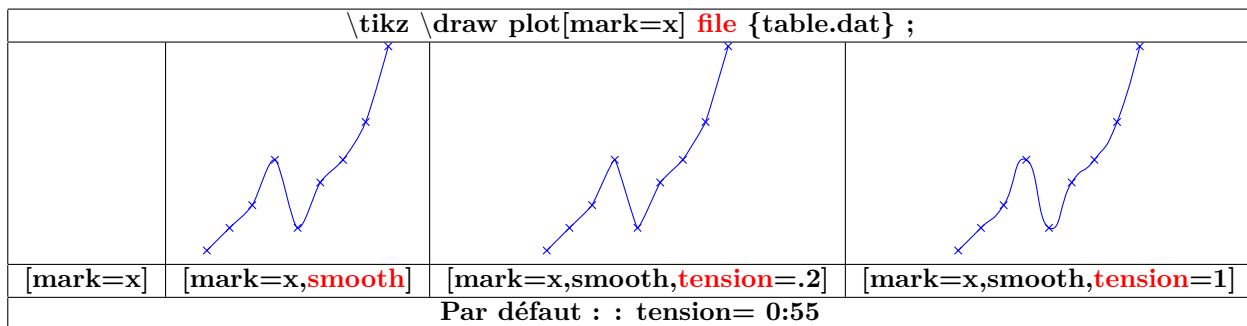

Contenu du fichier table.dat	
0.0	0.3
0.3	0.6
0.6	0.9
0.9	1.5
1.2	0.6
1.5	1.2
1.8	1.5
2.1	2.0
2.4	3.0

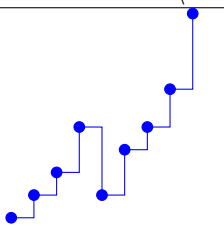
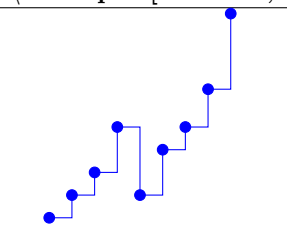
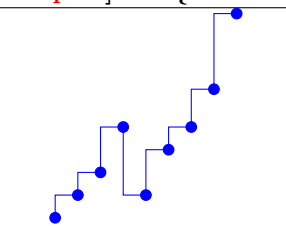
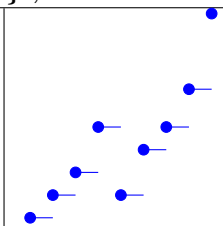
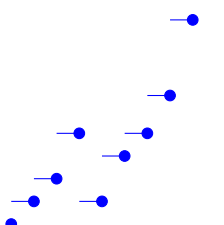
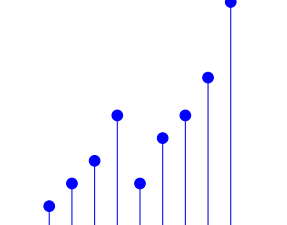
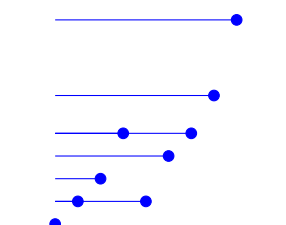
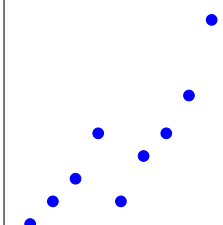

### 22.1.3 Les types de graphes

<code>\tikz \draw plot[mark=*,const plot] file {table.dat} ;</code>			
			
<b>const plot</b>	<b>const plot mark left</b>	<b>const plot mark right</b>	<b>jump mark left</b>
			
<b>jump mark right</b>	<b>ycomb</b>	<b>xcomb</b>	<b>only marks</b>

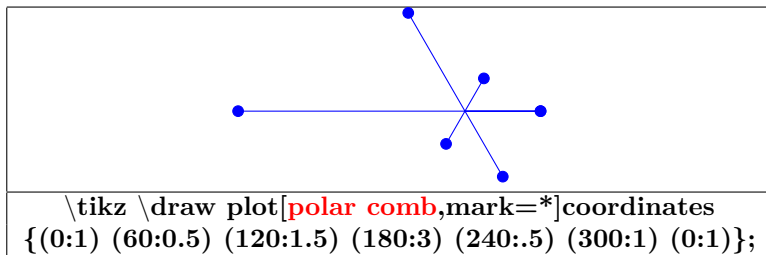

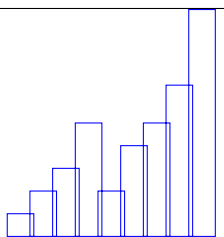
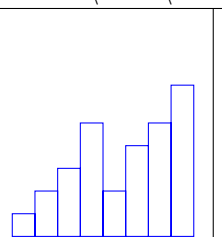
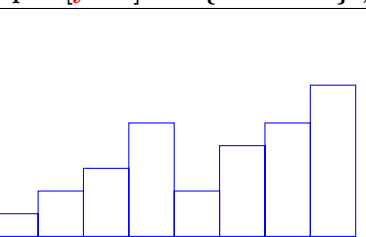
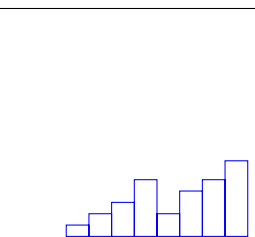
<code>\tikz \draw plot[ybar] file {table.dat} ;</code>			
			
<b>ybar</b>	<b>ybar interval</b>	<b>ybar interval,x=2cm</b>	<b>ybar interval,y=.5cm</b>

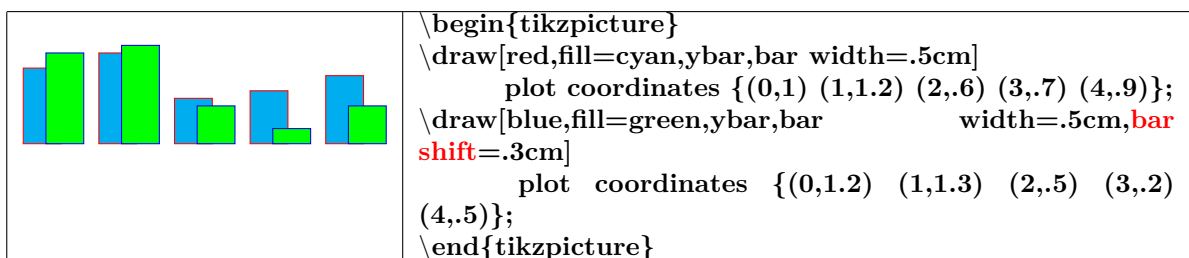

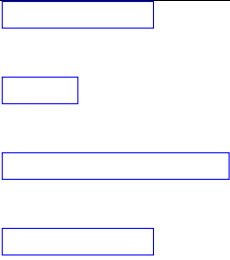
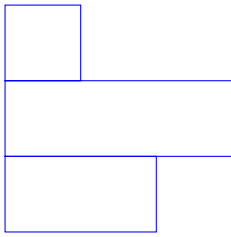
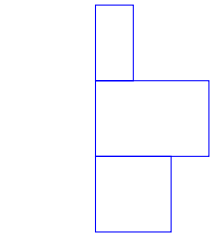
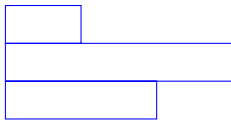
<code>\tikz \draw plot[xbar interval] file {table.dat} ;</code>			
			
<code>[xbar]</code>	<code>[xbar interval]</code>	<code>[xbar interval,x=.5cm]</code>	<code>[xbar interval,y=.5cm]</code>

### 22.1.4 Graphe à partir d'une fonction

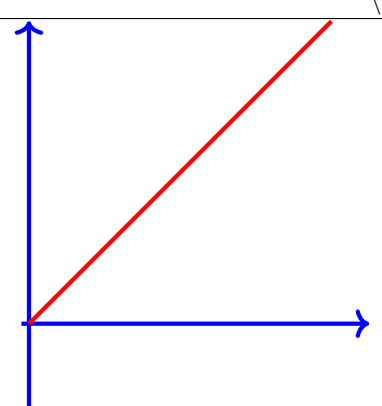
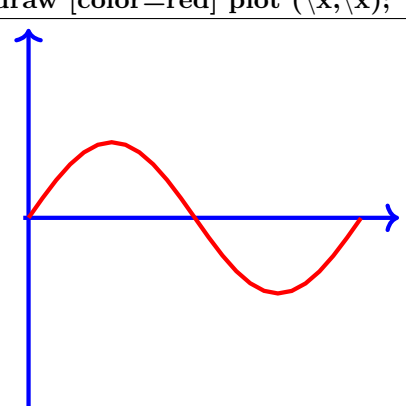
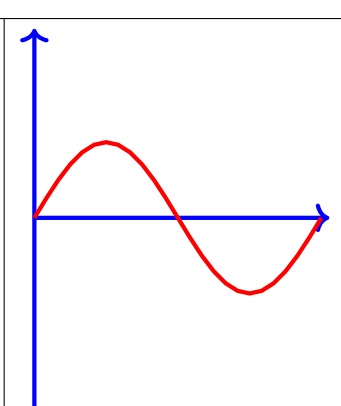
<code>\draw [color=red] plot (\x,\x);</code>		
		
$(\x,\x)$	$(\x,\{\sin(\x r)\})$ x en radian	$(\x,\{\sin(\x)\})$ x en degré

#### Options

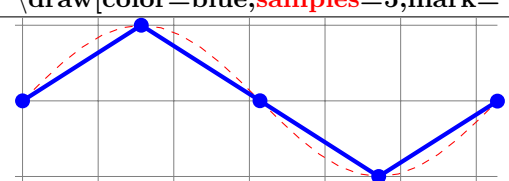
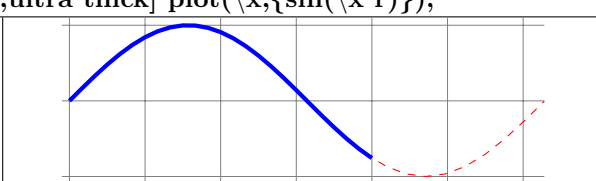
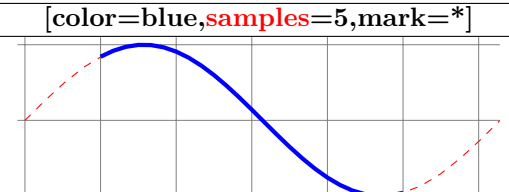
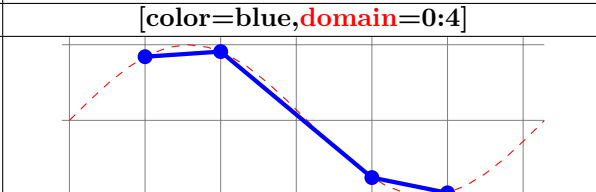
<code>\draw[color=red,dashed] plot(\x,\{\sin(\x r)\});</code>		<code>\draw[color=blue,samples=5,mark=*,ultra thick] plot(\x,\{\sin(\x r)\});</code>	
			
<code>[color=blue,samples=5,mark=*]</code>	<code>[color=blue,domain=0:4]</code>	<code>[color=blue,domain=1:5]</code>	<code>[color=blue,samples at={1,2,4,5},mark=*]</code>

### 22.1.5 Fonctions paramétriques

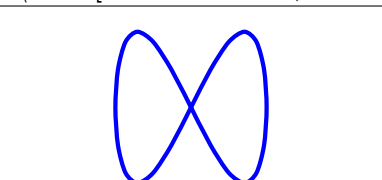
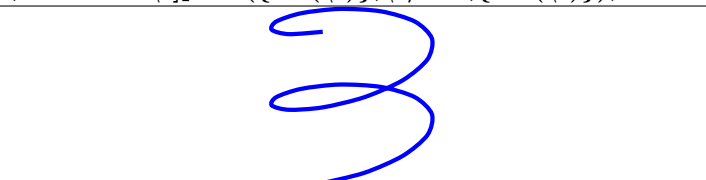
<code>\draw[domain=-3.141:3.141,smooth,variable=\t]plot ({sin(\t r)},{sin(2 *\t r)});</code>		<code>\draw[domain=0:720,smooth,variable=\t]plot ({sin(\t)},{t/360},{cos(\t)});</code>	
			
$(\{\sin(\t r)\},\{\sin(2 *\t r)\})$	$(\{\sin(\t)\},\t/360,\{\cos(\t)\})$		

## 22.2 Marques

### 22.2.1 Marques avec TikZ

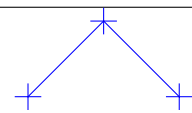
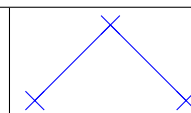
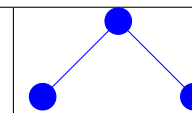
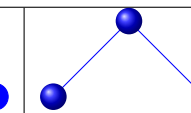
			
mark=+	mark=x	mark=*	mark=ball

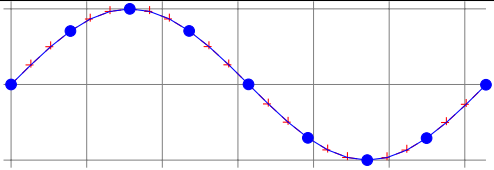
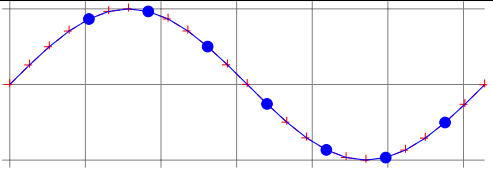
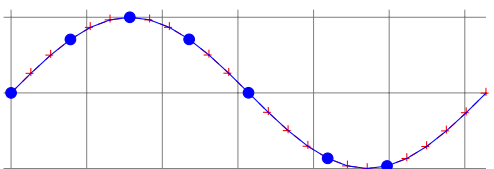
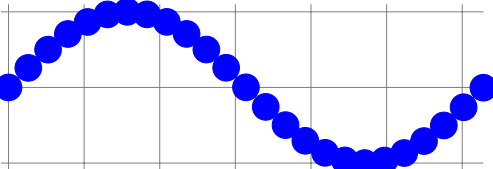
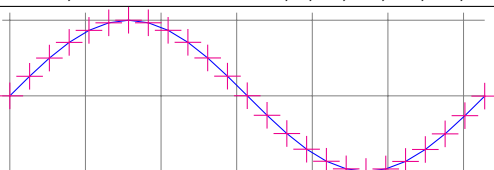
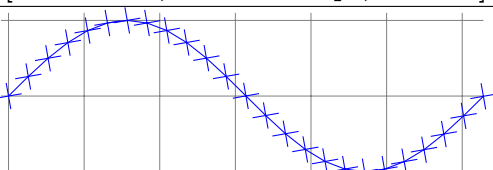
	
<code>[color=blue,mark repeat=3,mark=*]</code>	<code>[color=blue,mark repeat=3,mark phase=5,mark=*]</code>
	
<code>[color=blue,mark indices=1,4,...,15,17,20,mark=*]</code>	<code>[color=blue,mark size=5pt,mark=*]</code>
	
<code>mark options={color=magenta},mark=+</code>	<code>mark options={rotate=10},mark=+</code>

### 22.2.2 Marques personnalisées avec text mark

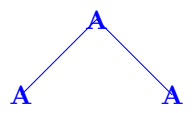
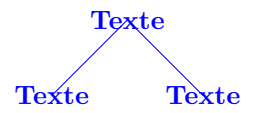
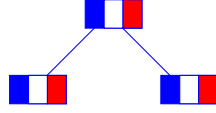
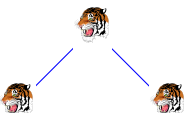
<code>\draw[mark=text ,text mark=A,mark size=5pt] coordinates {(0,0) (1,1) (2,0)};</code>		
		
<code>text mark=A</code>	<code>text mark=Texte</code>	<code>text mark=\DFR 88</code>
		
<code>text mark={\includegraphics[width=.5cm]{tiger}}</code>		

### 22.2.3 Marques avec l'extension plotmarks

Charger l'extension: `\usetikzlibrary{plotmarks}`

PGFmanual section : 63

mark=-	mark=	mark=o	mark=asterisk
mark==star	mark==10-pointed star	mark=oplus	mark=oplus*
mark=otimes	mark=otimes*	mark=square	mark=square*
mark=triangle	mark=triangle*	mark=diamond	mark=diamond*
mark=halfdiamond*	mark=halfsquare*	mark=halfsquare right*	mark=halfsquare left*
mark=pentagon	mark=pentagon*	mark=Mercedes star	mark=Mercedes star flipped
mark=halfcircle	mark=halfcircle*	mark=heart	mark=text

`\draw[mark=halfcircle,mark color=red,mark size=5pt] coordinates {(0,0) (1,1) (2,0)};`

mark=halfcircle	mark=halfcircle*	mark=halfdiamond*	mark=halfsquare*

### 22.3 Graphes avec Gnuplot

`\draw[color=red] plot[id=sin] function{sin(x)} ;`

==> `plot[id=sin]` crée le fichier "sin.gnuplot"

==> Ouvrir le fichier "sin.gnuplot" avec le programme gnuplot pour créer le fichier "sin.table"

==> Utiliser le fichier de données "sin.table"

## 23 Créer un graphe avec pgfplot

Charger l'extension: `\usepackage{pgfplots}` [2]

### 23.1 Courbes 2 D

#### 23.1.1 Axes

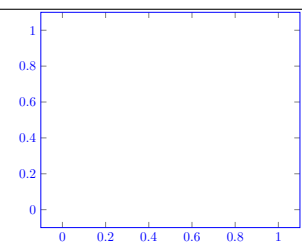
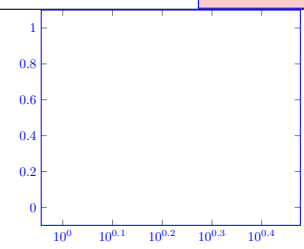
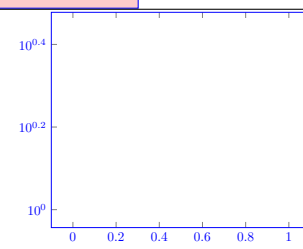
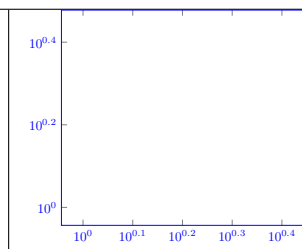
pgfplots section : 4-1			
			
<code>\begin{axis}</code>	<code>\begin{semilogxaxis}</code>	<code>\begin{semilogyaxis}</code>	<code>\begin{loglogaxis}</code>
<code>\end{axis}</code>	<code>\end{semilogxaxis}</code>	<code>\end{semilogyaxis}</code>	<code>\end{loglogaxis}</code>

### 23.2 Tracé de la courbe

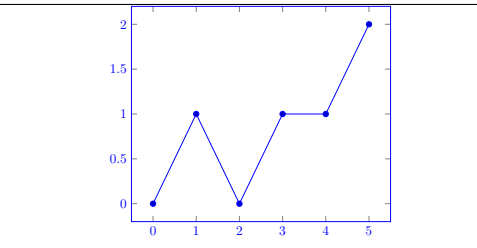
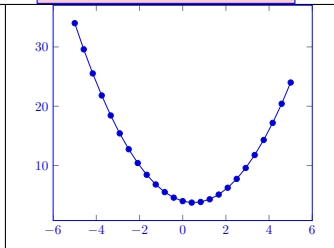
pgfplots section : 4-2		
		
<code>\addplot coordinates</code> <code>{(0,0) (1,1) (2,0) (3,1) (4,1) (5,2)};</code>	<code>\addplot {x^2 - x +4};</code>	<code>\addplot gnuplot[id=sin]{sin(x)};</code>

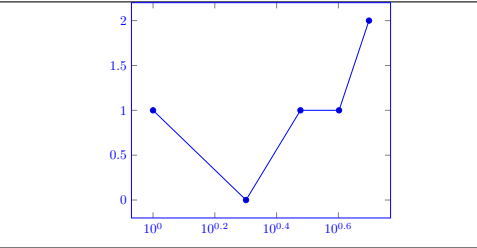
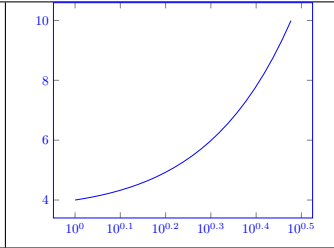
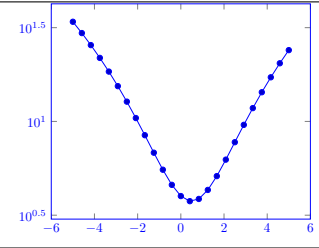
		
axes : <b>semilogxaxis</b>	axes : <b>semilogxaxis</b>	axes : <b>semilogyaxis</b>
<code>\addplot coordinates</code> <code>{(0,0) (1,1) (2,0) (3,1) (4,1) (5,2)};</code>	<code>\addplot {x^2 - x +4};</code>	<code>\addplot {x^2 - x +4};</code>

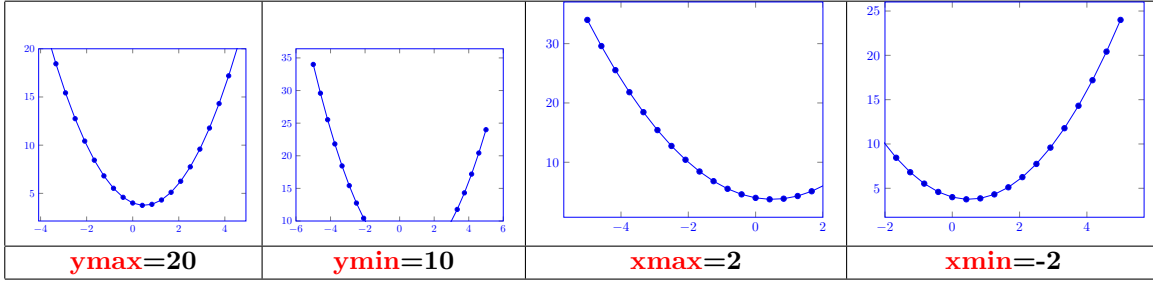
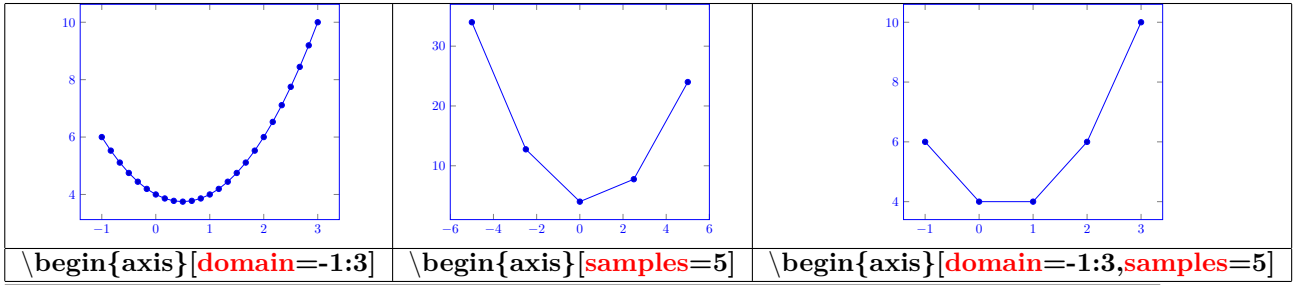

### 23.2.1 Dimension unitaire en X et Y

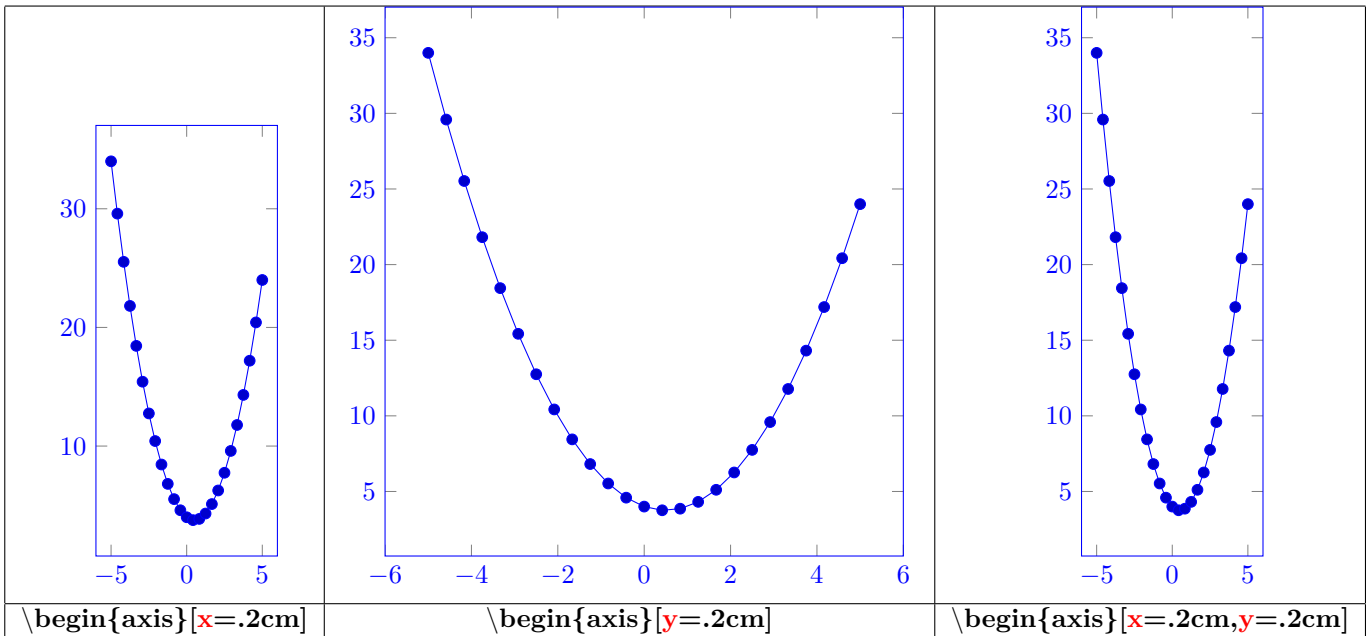

### 23.2.2 Type de graphiques

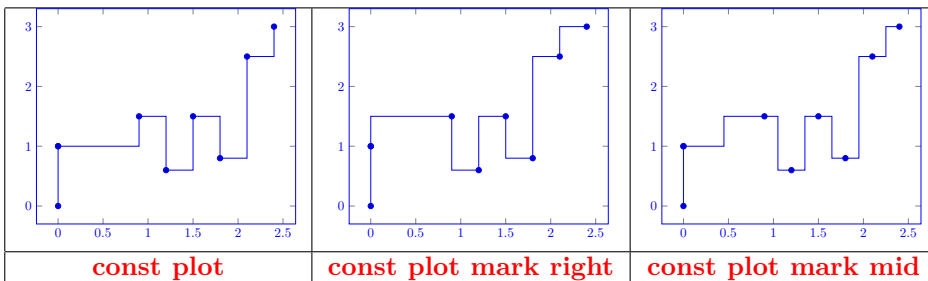

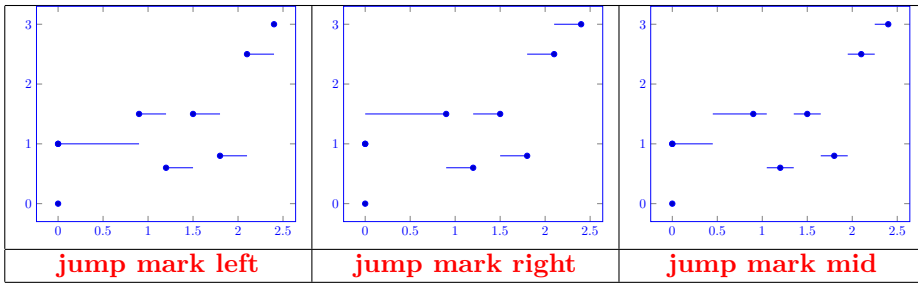

jump mark left

jump mark right

jump mark mid

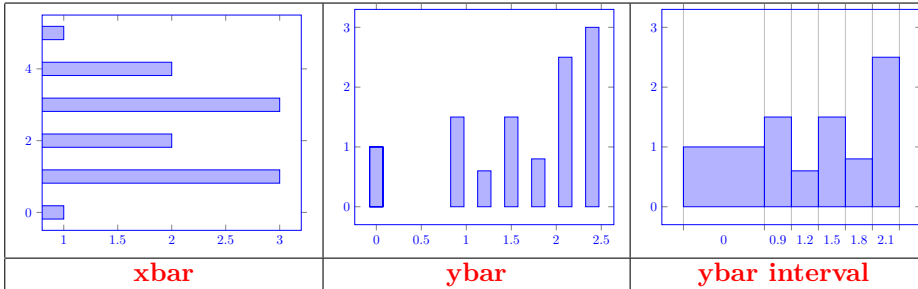

xbar

ybar

ybar interval

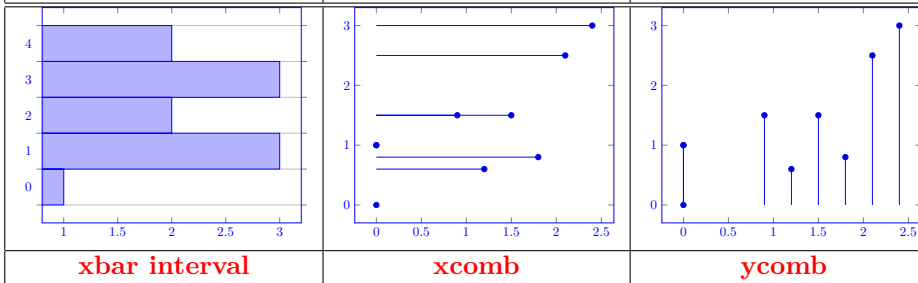

xbar interval

xcomb

ycomb

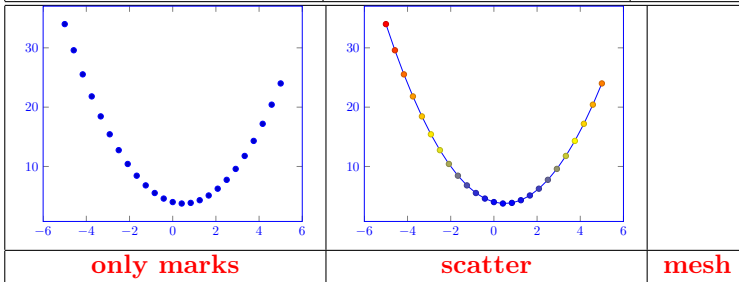

only marks

scatter

mesh

`\addplot [quiver={u=1,v=2*x}],->,samples=5,blue,ultra thick] {x^2 - x +4};`

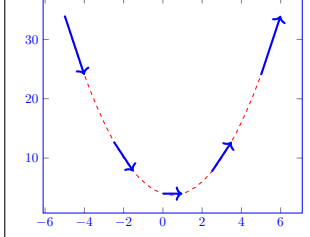

quiver= $u=1, v=2*x$

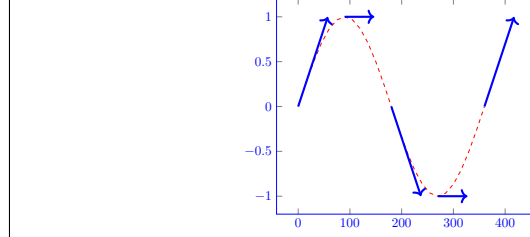

quiver= $\{u=180/3.14, v=\cos(x)\}$

Par défaut : :  $u=0$  et  $v = 0$



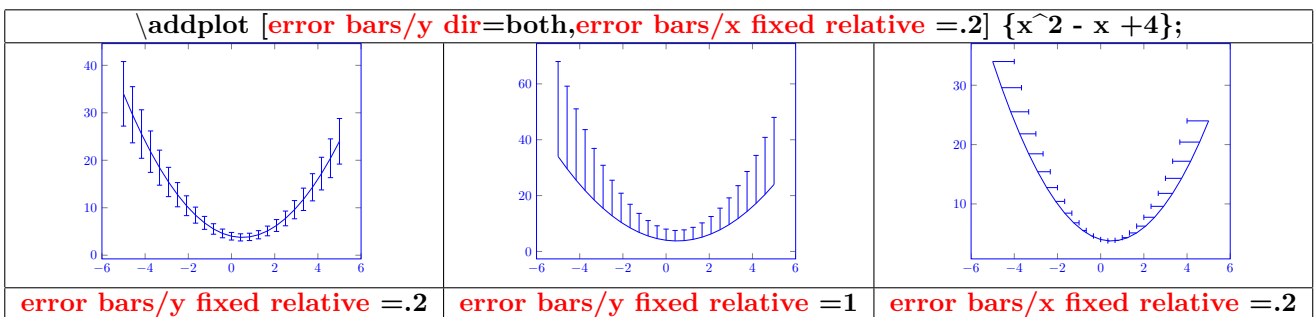
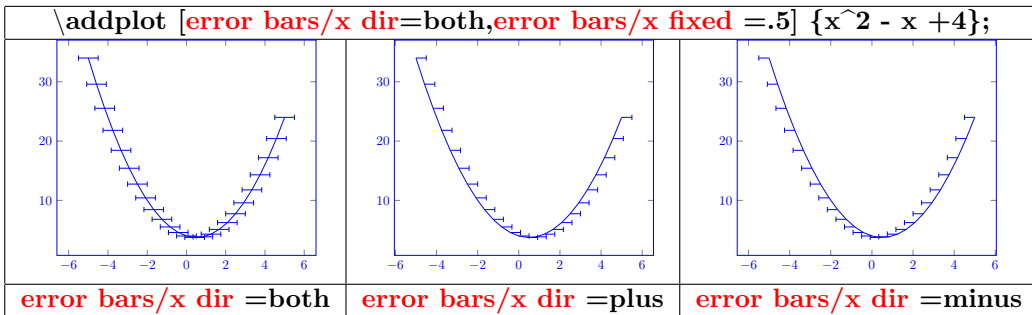
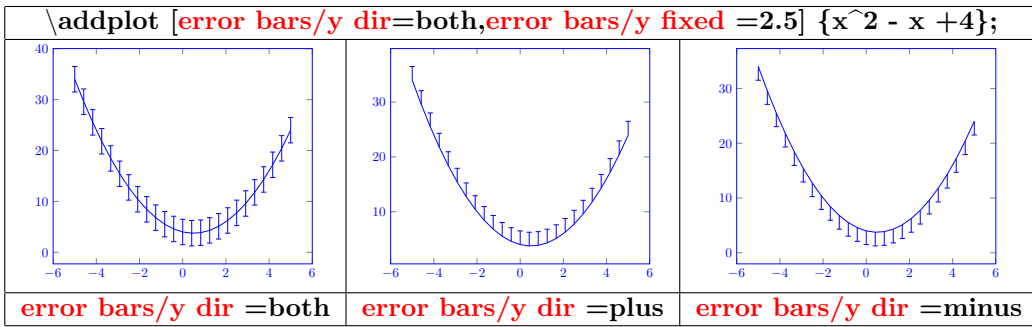
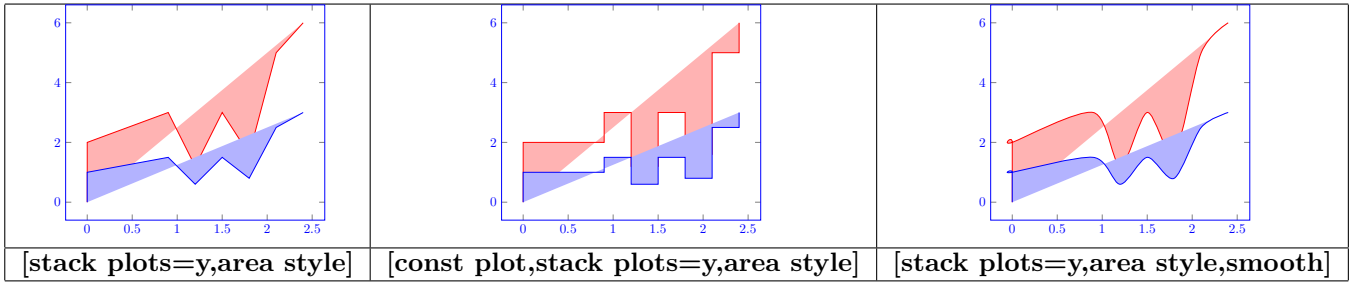
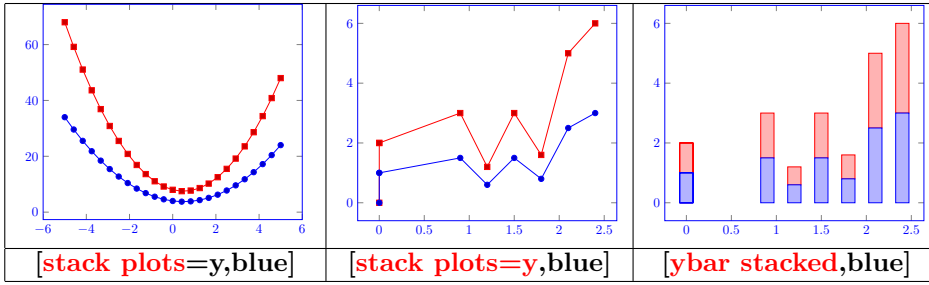

## 23.3 Habillage du graphe

### 23.3.1 Titres

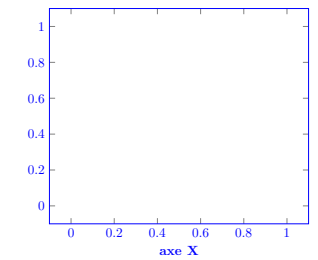
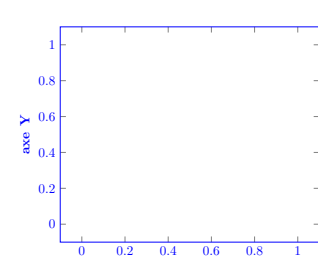
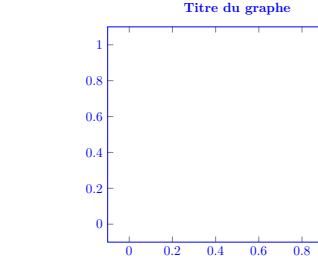
		
<code>\begin{axis}[xlabel=axe X]</code>	<code>\begin{axis}[ylabel=axe Y]</code>	<code>\begin{axis}[title=Titre du graphe]</code>

### 23.3.2 Légende

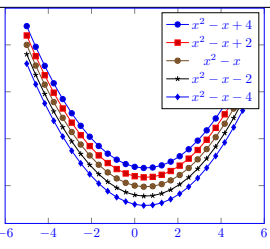
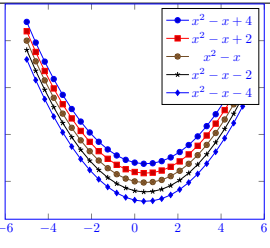
	<pre> \begin{axis} \addplot {x^2 - x + 4}; \addplot {x^2 - x + 2}; \addplot {x^2 - x}; \addplot {x^2 - x - 2}; \addplot {x^2 - x - 4};  \legend{\$x^2 - x + 4\$, \$x^2 - x + 2\$, \$x^2 - x\$, \$x^2 - x - 2\$, \$x^2 - x - 4\$} \end{axis} </pre>
	<pre> \begin{axis}[legend entries = { \$ x^2 - x + 4 \$, \$ x^2 - x + 2 \$, \$ x^2 - x \$, \$ x^2 - x - 2 \$, \$ x^2 - x - 4 \$ } ] \addplot {x^2 - x + 4}; \addplot {x^2 - x + 2}; \addplot {x^2 - x}; \addplot {x^2 - x - 2}; \addplot {x^2 - x - 4}; \end{axis} </pre>

#### Options

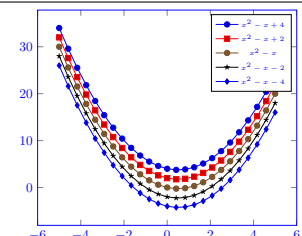
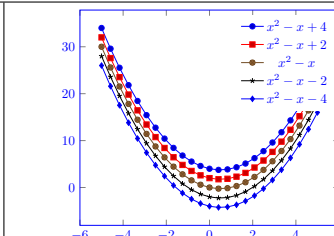
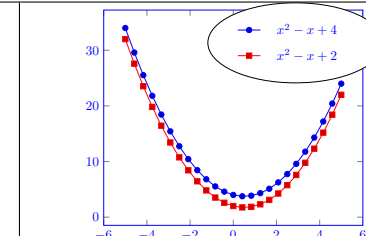
		
<code>legend style={font=\tiny}</code>	<code>legend style={draw=none}</code>	<code>legend style={shape=ellipse}</code>

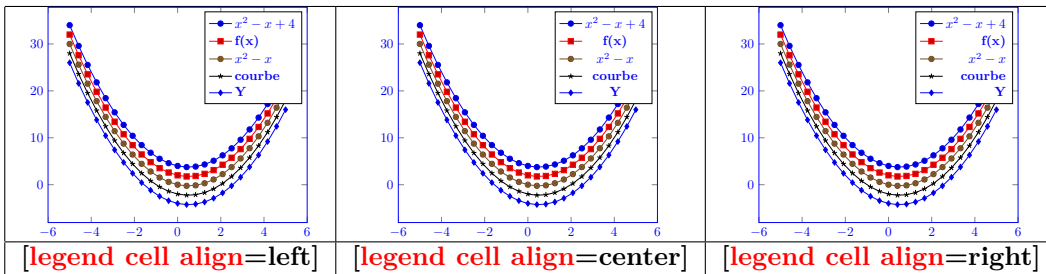
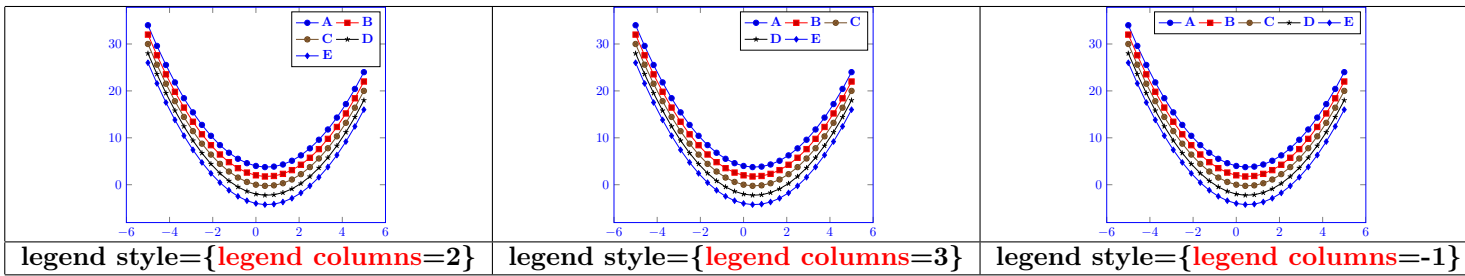
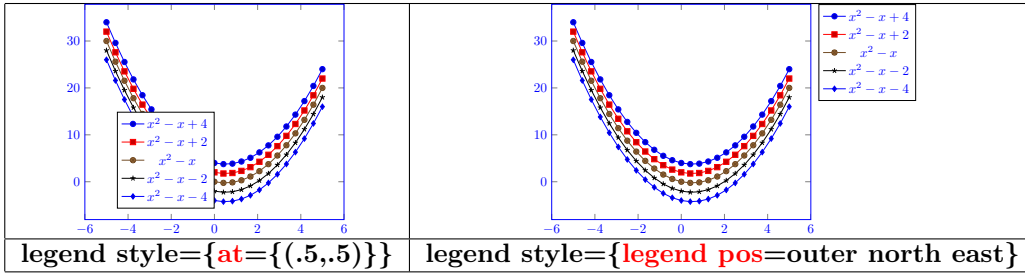

### 23.3.3 Taille du graphe

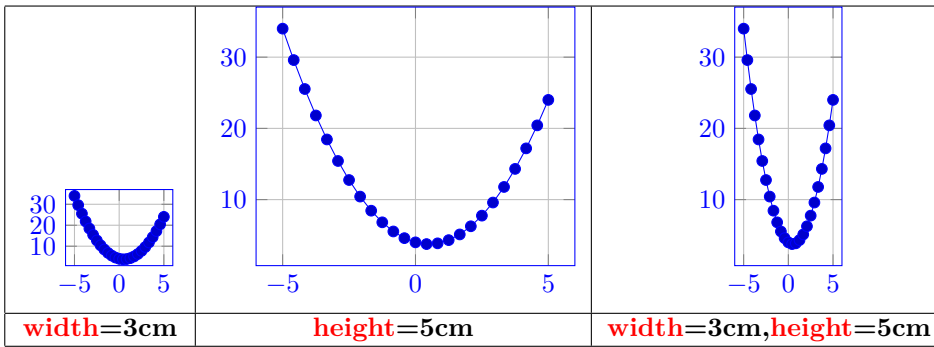

### 23.3.4 Quadrillage

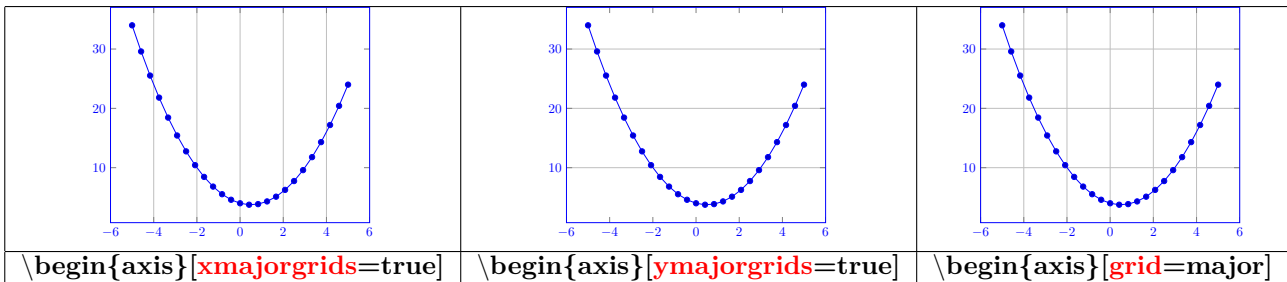

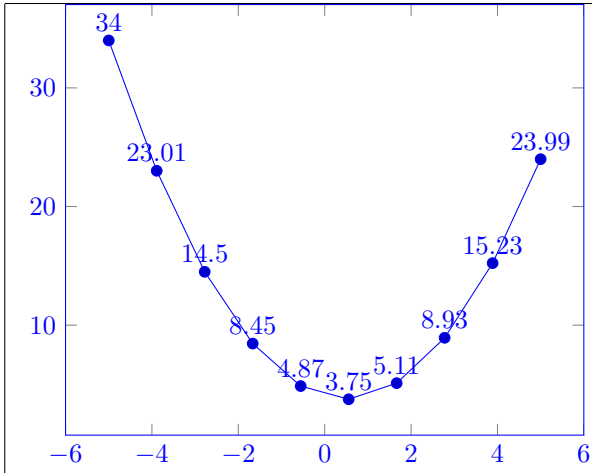

```
\beginACaxis[nodes near coords,samples=10]
\addplot {x^2-x+4};
```

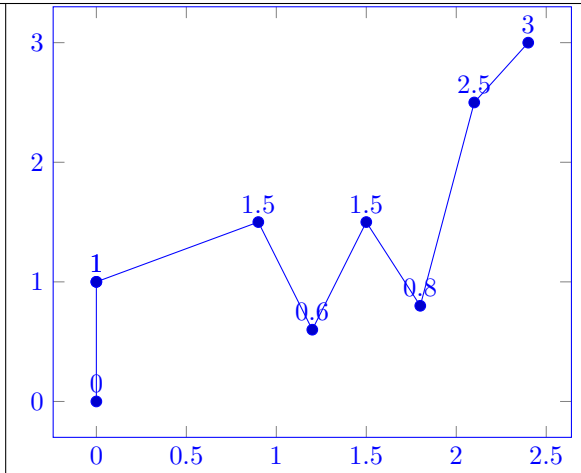

```
\beginACaxis[nodes near coords]
\addplot file table2.dat;
```

## 24 Courbes 3D

### 24.0.1 Axes

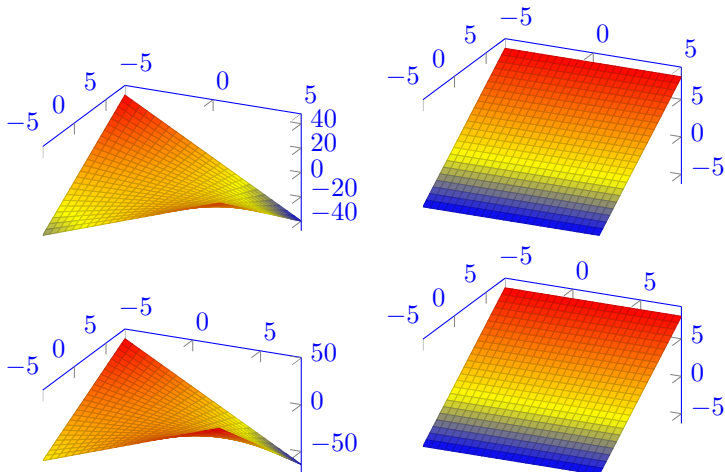
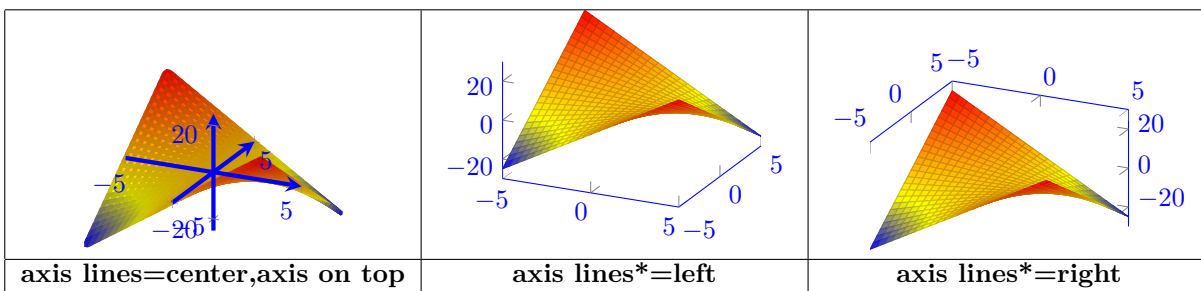
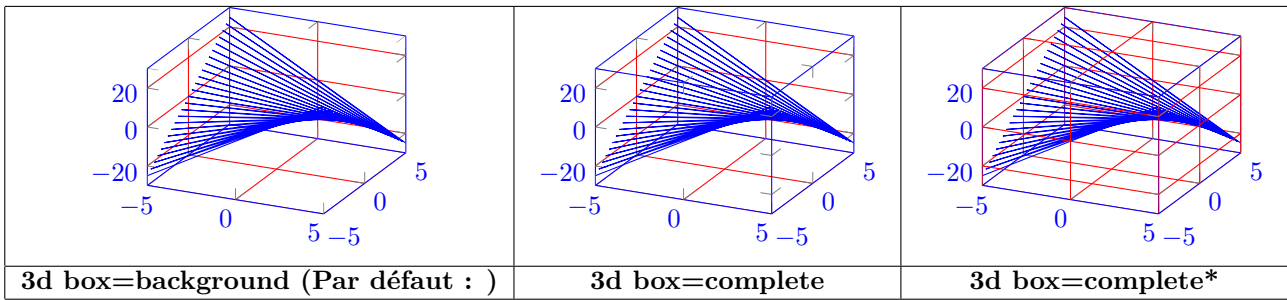
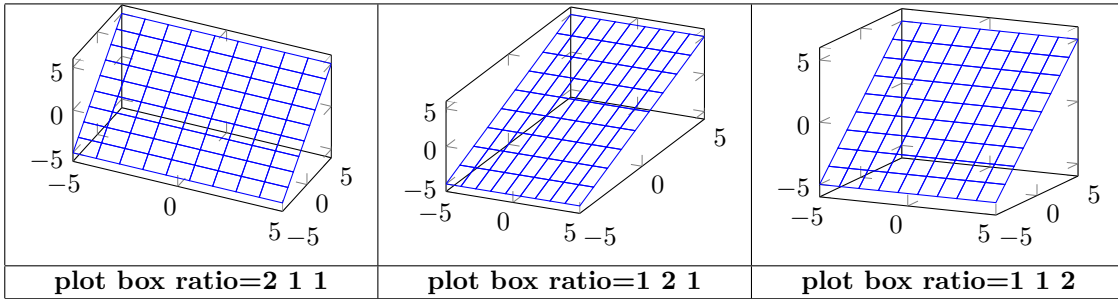

### 24.0.2 Tracé de la courbe

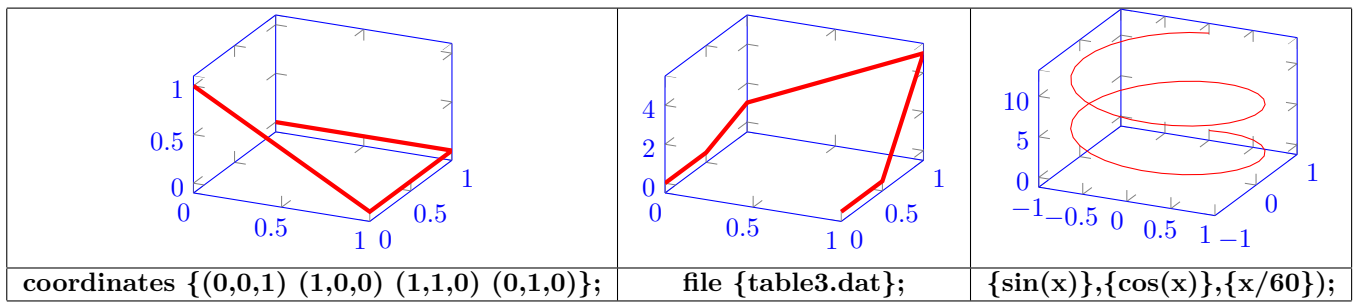
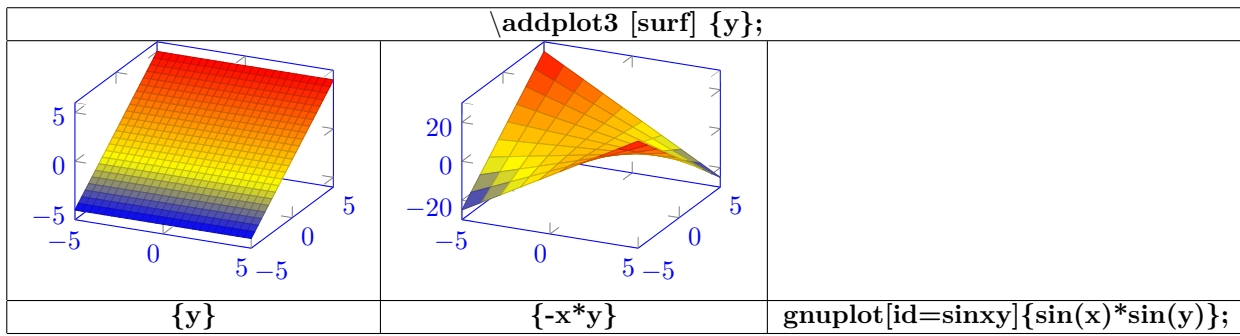

Contenu du fichier table3.dat		
0	0	0
0	0.5	0
0	1	1
1	1	5
1	0.5	0
1	0	0

### 24.0.3 Aspect

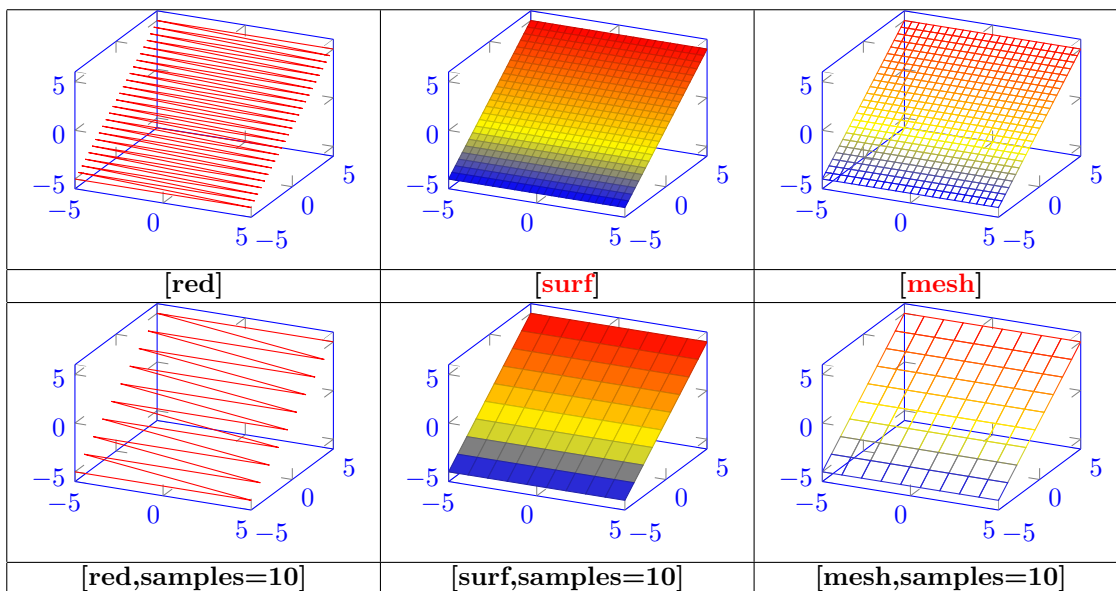

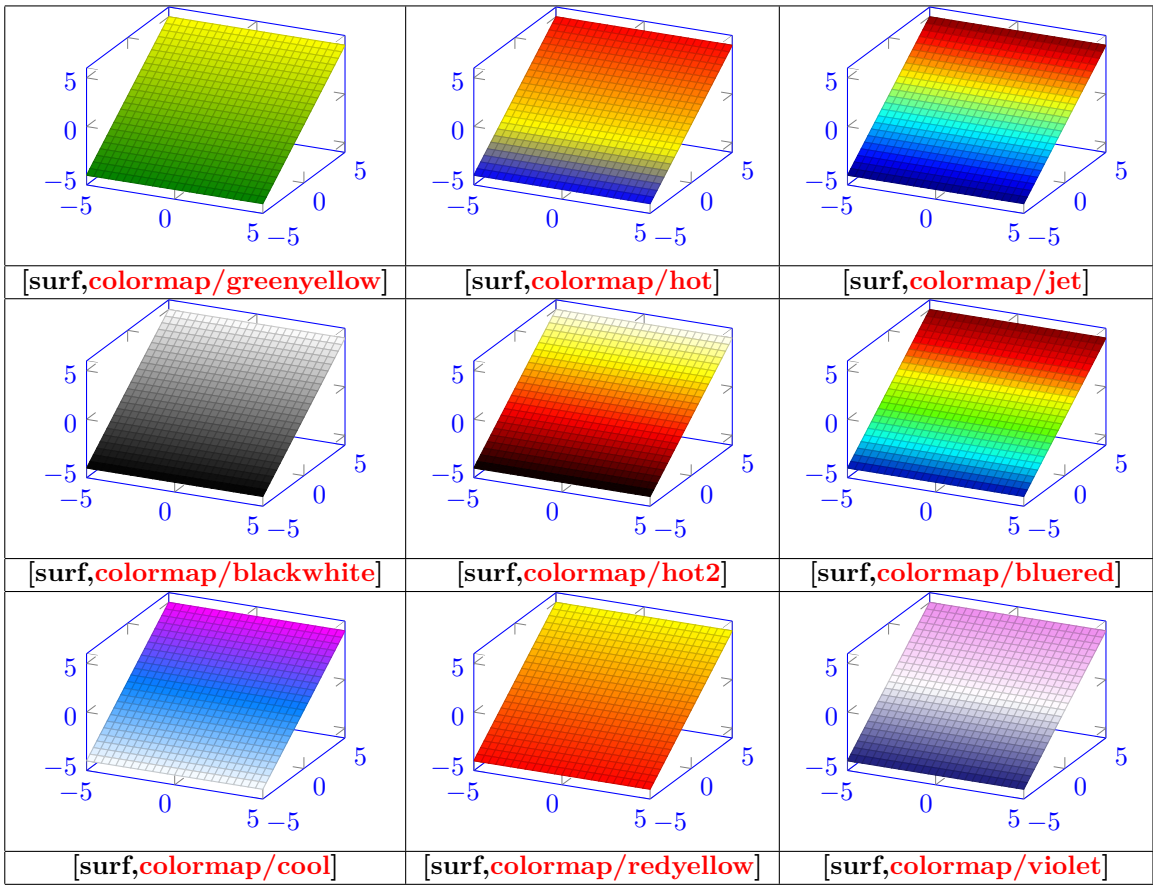
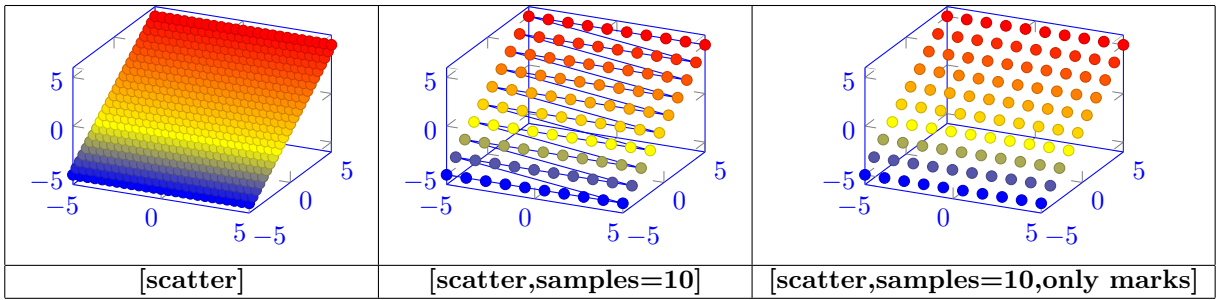

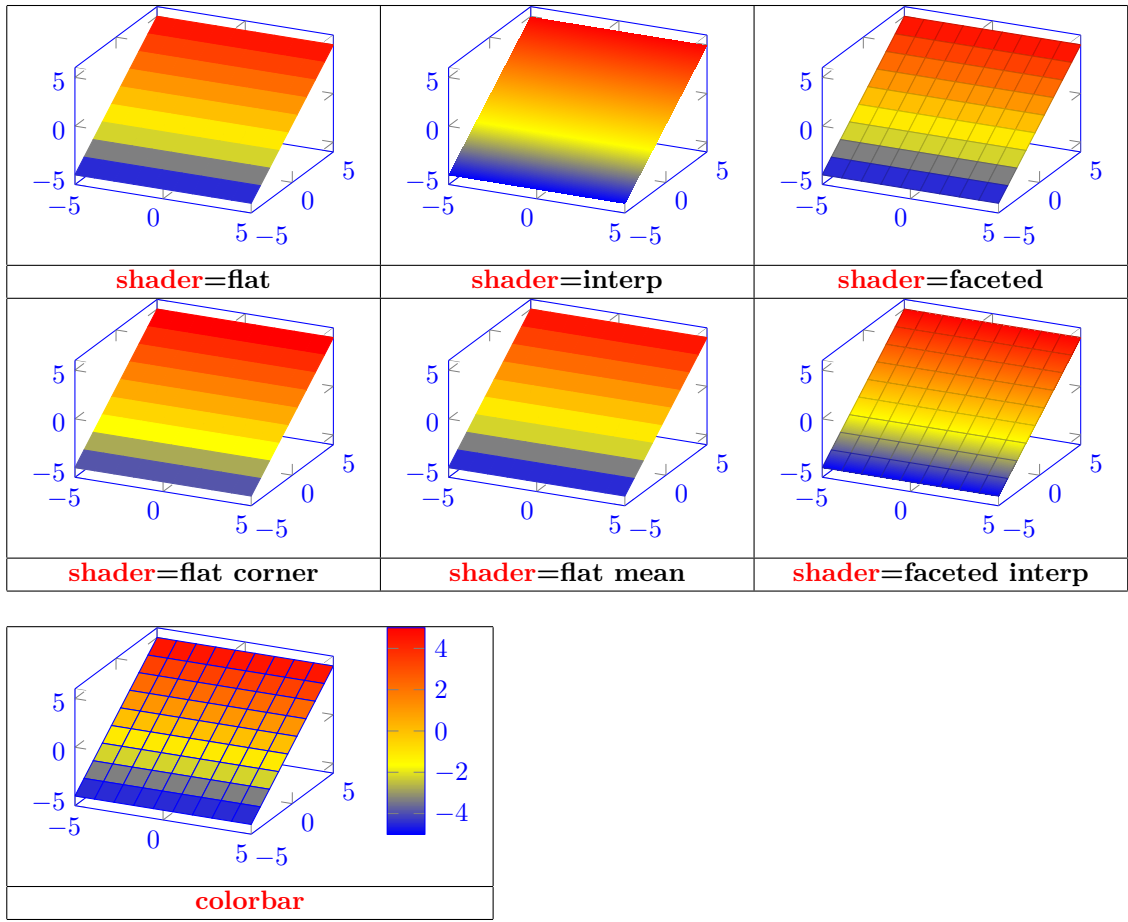

24.0.4 Point de vue

**Azimut**  
**view/az=** angle de - 50 à +50

**Elévation**  
**view/el=** angle de - 50 à +50



## 25 Les Tableaux de variation

Charger l'extension: `\usepackage{tkz-tab}` [3]

### 25.1 Déclaration du tableau

1° ligne	a	b	c
2° ligne			

```
\begin{tikzpicture}
\tkzTabInit{1° ligne / 1 ,2° ligne /1 } { a , b , c }
\end{tikzpicture}
```

#### 25.1.1 Options

Hauteur des ligne			
1° ligne	a	b	c
2° ligne			
3° ligne			

```
\tikz \tkzTabInit{1° ligne '/1 , 2° ligne /.5 , 3° ligne /1.5 }{a , b , c };
```

Largeur de la première colonne			
$x$	a	b	c

```
\tkzTabInit[lgt=4]{ x / 1}{ a , b , c };
Par défaut : : lgt==2 cm
```

Espacement entre deux valeurs			
$x$	a	b	c

```
\tkzTabInit[espcl=1]{ x / 1}{ a , b , c };
Par défaut : : espcl=2 cm
```

Marge de début et de fin			
$x$	a	b	c

```
\tkzTabInit[deltacl=1]{ x / 1}{ a , b , c };
Par défaut : : deltacl=0.5 cm
```

Épaisseur des lignes du tableau			
$x$	a	b	c

`\tkzTabInit[dlw=2pt]{ x / 1}{ a , b , c };`  
Par défaut : : lw=0,4 pt

Absence de cadre			
$x$	a	b	c

`\tkzTabInit[nocadre]{ x / 1}{ a , b , c };`  
Par défaut : : nocadre=false

Mise en couleur			
<code>\tkzTabInit [color,colorT = yellow]{1°ligne/1 , 2°ligne/1}{ a , b }</code>			
1°ligne	a	b	
2°ligne			
<code>[color,colorT = yellow]</code>		<code>[color,colorC = cyan]</code>	
1°ligne	a	b	
2°ligne			
<code>[color,colorL = green]</code>		<code>[color,colorV = magenta]</code>	
1°ligne	a	b	
2°ligne			
Par défaut : : color = false		colorT=colorC=colorL=colorV =white	

## 25.2 Création d'une ligne de signes

$x$	a	b	c
$f(x)$	2	4	

`\tkzTabLine{ t, 2,t ,4 ,t }`

$x$	a	b	c
$f(x)$	0	2	0
	0	4	0

`\tkzTabLine{ z, 2, z ,4 ,z }`

$x$	a	b	c
$f(x)$	2	4	

`\tkzTabLine{ d, 2, d ,4 ,d }`

$x$	a	b	c
$f(x)$	1	3	5

`\tkzTabLine{ 1, h, 3 ,4 ,5 }`

Exemple					
$x$	$-\infty$	$-4$	$4$	$10$	$+\infty$
$f(x)$	⋮	+	▨	- 0 +	⋮





```

\begin{tikzpicture}
\tkzTabInit[espc1=1.5]{ $x$  / 1 ,  $f(x)$  / 1 } {  $-\infty$  ,  $-4$  ,  $4$  ,  $10$  ,  $+\infty$  }
\tkzTabLine{ t,+ , d , h , d,-,z,+ }
\end{tikzpicture}

```

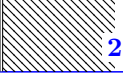
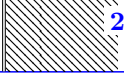
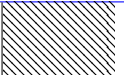
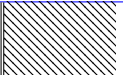
### 25.3 Création d'une ligne de variations

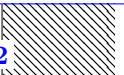
$x$	$a$	$b$	$c$	$x$	$a$	$b$	$c$
$f(x)$	1	→	2	$f(x)$	1	→	2
$\backslash\text{tkzTabVar}\{ +/1 , -/2 \}$				$\backslash\text{tkzTabVar}\{ -/1 , +/2 \}$			
$x$	$a$	$b$	$c$	$x$	$a$	$b$	$c$
$f(x)$	1	→	2	$f(x)$	1	→	2
$\backslash\text{tkzTabVar}\{-/1 , -/2 \}$				$\backslash\text{tkzTabVar}\{ +/1 , +/2 \}$			
$x$	$a$	$b$	$c$	$x$	$a$	$b$	$c$
$f(x)$	1	→	2	$f(x)$	1	→	2
$\backslash\text{tkzTabVar}\{ +C/1 , -/2 \}$				$\backslash\text{tkzTabVar}\{ -C/1 , +/2 \}$			
$x$	$a$	$b$	$c$	$x$	$a$	$b$	$c$
$f(x)$	1	→	2	$f(x)$	1	→	2
$\backslash\text{tkzTabVar}\{-/1 , -C/2 \}$				$\backslash\text{tkzTabVar}\{ +/1 , +C/2 \}$			
$x$	$a$	$b$	$c$	$x$	$a$	$b$	$c$
$f(x)$	1	▨	2	$f(x)$	1	▨	2
$\backslash\text{tkzTabVar}\{ +H/1 , -/2 \}$				$\backslash\text{tkzTabVar}\{ -H/1 , +/2 \}$			
$x$	$a$	$b$	$c$	$x$	$a$	$b$	$c$
$f(x)$	1	→	2	$f(x)$	1	→	2
$\backslash\text{tkzTabVar}\{-/1 , -H/2 \}$				$\backslash\text{tkzTabVar}\{ +/1 , +H/2 \}$			

$x$	a	b	c	$x$	a	b	c
$f(x)$	1	$\longrightarrow$	2	$f(x)$	1	$\nearrow$	2
$\backslash\text{tkzTabVar}\{ +D/1 , -/2\}$				$\backslash\text{tkzTabVar}\{ -D/1 , +/2\}$			
$x$	a	b	c	$x$	a	b	c
$f(x)$	1	$\searrow$	2	$f(x)$	1	$\nearrow$	2
$\backslash\text{tkzTabVar}\{-/1 , -D/2\}$				$\backslash\text{tkzTabVar}\{ +/1 , +D/2\}$			
$x$	a	b	c	$x$	a	b	c
$f(x)$		1	$\searrow$	$f(x)$		1	$\nearrow$
$\backslash\text{tkzTabVar}\{ D+/1 , -/2\}$				$\backslash\text{tkzTabVar}\{ D-/1 , +/2\}$			
$x$	a	b	c	$x$	a	b	c
$f(x)$	1	$\longrightarrow$	2	$f(x)$	1	$\nearrow$	2
$\backslash\text{tkzTabVar}\{-/1 , D-/2\}$				$\backslash\text{tkzTabVar}\{ +/1 , D+/2\}$			
$x$	a	b	c	$x$	a	b	c
$f(x)$	1		2	$f(x)$	1		2
$\backslash\text{tkzTabVar}\{ +DH/1 , -/2\}$				$\backslash\text{tkzTabVar}\{ -DH/1 , +/2\}$			
$x$	a	b	c	$x$	a	b	c
$f(x)$	1	$\searrow$		$f(x)$	1	$\nearrow$	
$\backslash\text{tkzTabVar}\{-/1 , -DH/2\}$				$\backslash\text{tkzTabVar}\{ +DH/1 , +/2\}$			
$x$	a	b	c	$x$	a	b	c
$f(x)$		1	2	$f(x)$		1	2
$\backslash\text{tkzTabVar}\{ +CH/1 , -/2\}$				$\backslash\text{tkzTabVar}\{ -CH/1 , +/2\}$			
$x$	a	b	c	$x$	a	b	c
$f(x)$	1	$\searrow$		$f(x)$	1	$\nearrow$	
$\backslash\text{tkzTabVar}\{-/1 , -CH/2\}$				$\backslash\text{tkzTabVar}\{ +/1 , +CH/2\}$			

$x$	a	b	c	$x$	a	b	c
$f(x)$	1	→ 2	2 → 3	$f(x)$	1	→ 2	2 → 3
$\backslash\text{tkzTabVar}\{-/1, +\mathbf{D-}/2, +/3\}$				$\backslash\text{tkzTabVar}\{+/1, -\mathbf{D+}/2, -/3\}$			
$x$	a	b	c	$x$	a	b	c
$f(x)$	1	→ 2	2 → 3	$f(x)$	1	→ 2	2 → 3
$\backslash\text{tkzTabVar}\{+/1, -\mathbf{D-}/2, +/3\}$				$\backslash\text{tkzTabVar}\{-/1, +\mathbf{D+}/2, -/3\}$			
$x$	a	b	c	$x$	a	b	c
$f(x)$	1	→ 2	2 → 3	$f(x)$	1	→ 2	2 → 3
$\backslash\text{tkzTabVar}\{-/1, +\mathbf{CD-}/2, +/3\}$				$\backslash\text{tkzTabVar}\{+/1, -\mathbf{CD+}/2, -/3\}$			
$x$	a	b	c	$x$	a	b	c
$f(x)$	1	→ 2	2 → 3	$f(x)$	1		→ 3
$\backslash\text{tkzTabVar}\{+/1, -\mathbf{CD-}/2, +/3\}$				$\backslash\text{tkzTabVar}\{-/1, +\mathbf{CD+}/2, -/3\}$			
$x$	a	b	c	$x$	a	b	c
$f(x)$	1	→ 2	2 → 3	$f(x)$	1	→ 2	2 → 3
$\backslash\text{tkzTabVar}\{-/1, +\mathbf{DC-}/2, +/3\}$				$\backslash\text{tkzTabVar}\{+/1, -\mathbf{DC+}/2, -/3\}$			
$x$	a	b	c	$x$	a	b	c
$f(x)$	1	→ 2	2 → 3	$f(x)$	1	→ 2	2 → 3
$\backslash\text{tkzTabVar}\{+/1, -\mathbf{DC-}/2, +/3\}$				$\backslash\text{tkzTabVar}\{-/1, +\mathbf{DC+}/2, -/3\}$			
$x$	a	b	c	$x$	a	b	c
$f(x)$	1	→ 2	2 → 3	$f(x)$	1	→ 2	2 → 3
$\backslash\text{tkzTabVar}\{-/1, +\mathbf{V-}/2, +/3\}$				$\backslash\text{tkzTabVar}\{+/1, -\mathbf{V+}/2, -/3\}$			
$x$	a	b	c	$x$	a	b	c
$f(x)$	1	→ 2	2 → 3	$f(x)$	1	→ 2	2 → 3
$\backslash\text{tkzTabVar}\{+/1, -\mathbf{V-}/2, +/3\}$				$\backslash\text{tkzTabVar}\{-/1, +\mathbf{V+}/2, -/3\}$			

Mise en évidence d'une valeur			
$x$	a	b	c
$f(x)$	1	→ 2 2 →	3

`\tkzTabVar{+/1, -V-/\colorbox{yellow}{2}, +/3}`

Variation sur plusieurs colonnes			
$x$	a	b	c
$f(x)$	1 → 3		

`\tkzTabVar{-/1, R/, +/3}`

Valeurs intermédiaires									
$x$	a	A	b	c	$x$	a	b	A	c
$f(x)$	1 -x → 3				$f(x)$	1 → x → 3			

`\tkzTabVal{1}{3}{0.25}{A}{x}`      `\tkzTabVal{1}{3}{0.75}{A}{x}`

$x$	a	A	b	c
		⋮		
$f(x)$	1 -x → 3			

`\tkzTabVal[draw]{1}{3}{0.25}{A}{x}`

Ajout d'images									
$x$	a	b	c	d	$x$	a	b	c	d
$f(x)$	1 → x → 3				$f(x)$	1 → x → 3			

`\tkzTabIma{1}{4}{2}{x}`      `\tkzTabIma{1}{4}{3}{x}`

## 26 Les répétitions

Utilisation du module “pgffor” chargé automatiquement avec TikZ

### 26.1 Répétition à 1 variable

<code>\tikz \foreach \x in {1,...,10} \fill[blue](\x,0) circle (0.4cm);</code>
Variable <code>\x</code> : position en X

### 26.2 Répétition à 2 variables

Liste de variables numériques	
	
<code>\tikz \foreach \pos/\y in {1/10,2/20,3/30,4/40,5/50,6/60,7/70,8/80,9/90,10/100} \fill[color=blue!\y](\pos,0) circle (0.5cm);</code>	
Variable <code>\pos</code> : position en X	Variable <code>\y</code> : couleur

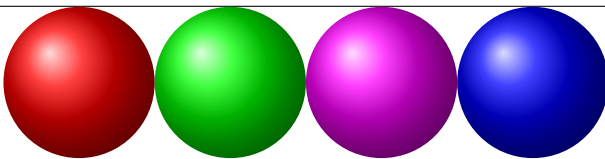
Liste de variables mixtes	
	
<code>\tikz \foreach \x/\col in 1/red,3/green,5/magenta,7/blue \shade[ball color=\col](\x,0) circle (1);</code>	
Variable <code>\x</code> : position en X	Variable <code>\col</code> : couleur

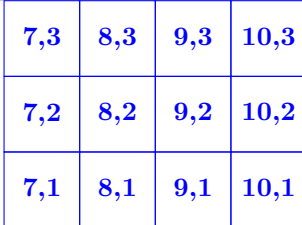
Liste de variables avec un pas	
	
<code>\begin{tikzpicture} \foreach \x in {1,2,...,4,7,8,...,10} \foreach \y in {1,...,3} { \draw (\x,\y) ++(-.5,-.5) rectangle ++(.5,.5); \draw (\x,\y) node[\x,\y]; } \end{tikzpicture}</code>	
Variable <code>\x</code> : position en X	Variable <code>\y</code> : position en Y

Exemples de liste	
1, 2, 3, 4, 5, 6,	<code>\foreach \x in {1,...,6} {\x, }</code>
1, 3, 5, 7, 9, 11,	<code>\foreach \x in {1,3,...,11} {\x, }</code>
Z, X, V, T, R, P, N,	<code>\foreach \x in {Z,X,...,M} {\x, }</code>
$2^1, 2^2, 2^3, 2^4, 2^5, 2^6, 2^7,$	<code>\foreach \x in {2^1,2^2,...,2^7} {\x, }</code>
0cm, 0.5cm, 1cm, 1.5cm, 2cm, 2.5cm, 3cm,	<code>\foreach \x in {0cm,0.5cm,...cm,3cm} {\x, }</code>
$A_1, B_1, C_1, D_1, E_1, F_1, G_1, H_1,$	<code>\foreach \x in {A_1,..._1,H_1} {\x, }</code>

Variables numériques avec opération

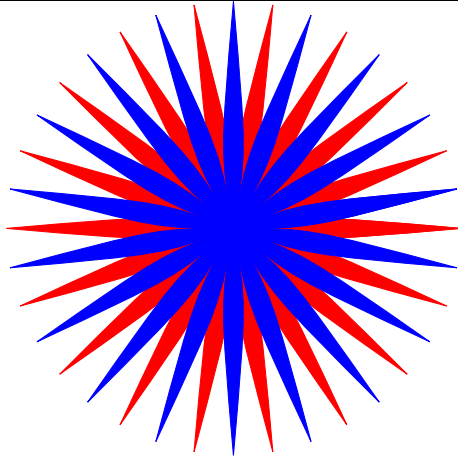

```
\begin{tikzpicture}
\foreach \x in 0,20,...,360{ \filldraw[red] (0,0) .. controls (\x+10:1)
.. (\x:1) .. controls (\x-10:1) .. (0,0);}
\foreach \x in 10,30,...,370{ \filldraw[blue] (0,0) .. controls (\x+10:3)
.. (\x:3) .. controls (\x-10:3) .. (0,0);}
\end{tikzpicture}
```

Variable `\x` : angle

26.3 Répétition à 2 variables - boucles imbriquées

Ordre des boucles imbriquées

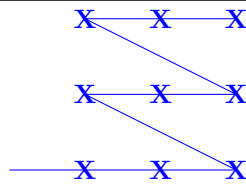
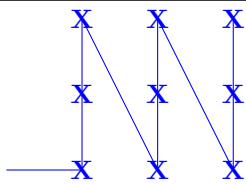

```
\begin{tikzpicture}
\draw (0,0)
\foreach \x in {1,2,3}
\foreach \y in {0,1,2}
{- (\x,\y) node{X}};
\end{tikzpicture}
```

```
\begin{tikzpicture}
\draw (0,0)
\foreach \y in {0,1,2}
\foreach \x in {1,2,3}
{- (\x,\y) node{X}};
\end{tikzpicture}
```





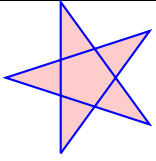

```
\filldraw[turtle/distance=2cm,thick,blue,fill=red!20]  
[ turtle=home ]  
\foreach \i in {1,...,5}  
[ turtle={forward,right=144} ] ;
```

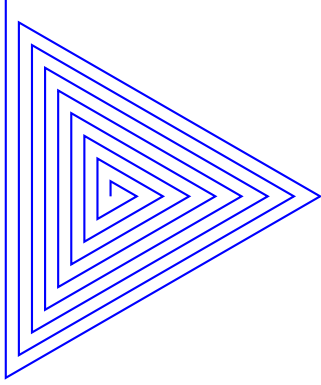

```
\draw[thick,blue]  
[ turtle=home ]  
\foreach \i in {1,...,25}  
[turtle={forward=\i/5,right=120} ] ;
```

## 28 Les diagrammes arborescents

PGFmanual section : 21

### 28.1 Structure

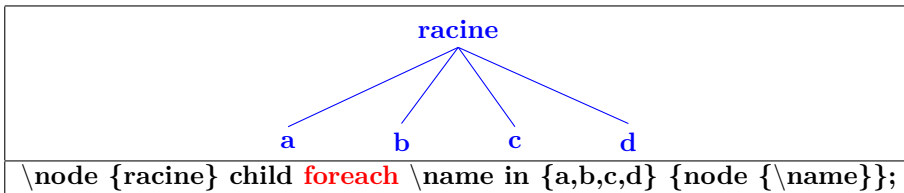
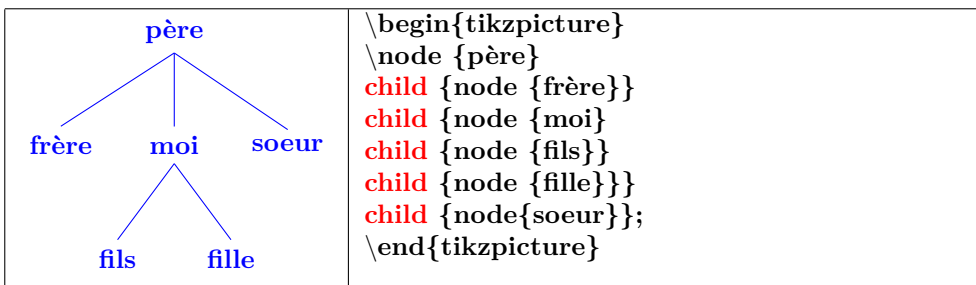
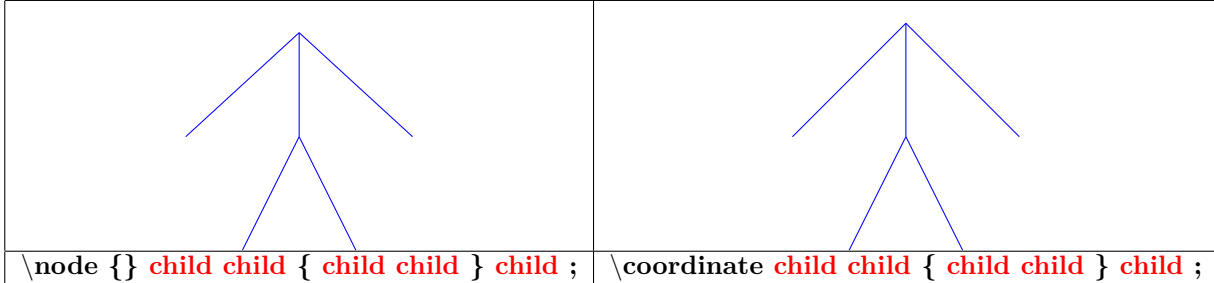

### 28.2 Orientation

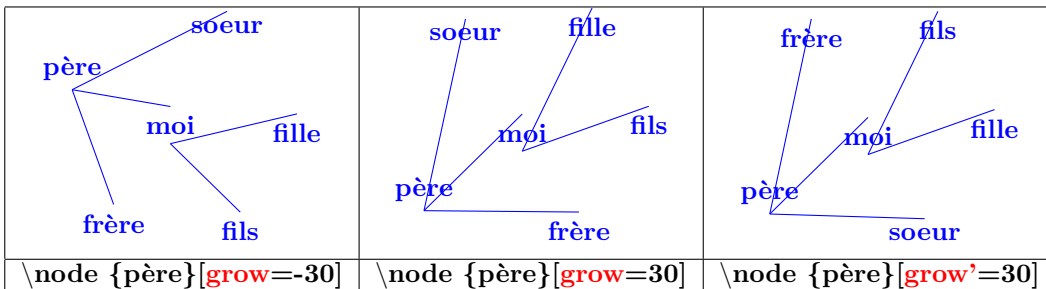

<code>\node {père}[grow=up]</code>	<code>\node {père}[grow=left]</code>	<code>\node {père}[grow=right]</code>
<code>\node {père}[grow=north]</code>	<code>\node {père}[grow=east]</code>	<code>\node {père}[grow=north east]</code>

	<pre> \node {père} child[grow=right,red] {node {frère}} child {node {moi}} child {node {fils}} child {node {filles}} child[grow=north west,red] {node{soeur}}; </pre>
--	---

### 28.3 Distance

### 28.4 Distance père fils

<code>\node {père}[level distance=3cm,red]</code>	<pre> child[level distance=3cm,red] {node {frère}} child[level distance=.5cm,red] {node {filles}} </pre>
Par défaut : : level distance=15 mm	

\node {père}[level 1/.style={level distance=1cm}]	\node {père}[level 2/.style={level distance=.5cm}]

### 28.5 Distance père fils

\node {père}[sibling distance=1cm,red]	\node {père}[sibling distance=3cm,red]
Par défaut : : sibling distance=15 mm	

Problème	solution
[sibling distance=2cm]	[level 1/.style=sibling distance=2cm, level 2/.style=sibling distance=1cm]

## 28.6 Personnalisation des noeuds

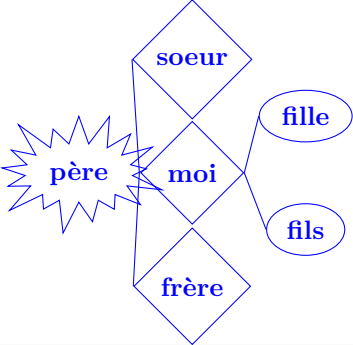
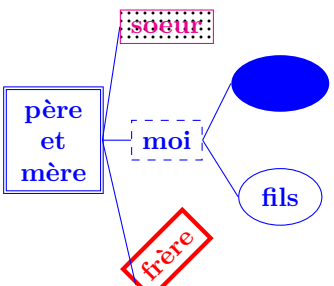
	<pre> \mode[starburst<sup>1</sup>,draw] {père}[grow=right]  child {node[diamond,draw] frère} child {node[diamond,draw] moi} child {node[ellipse,draw] fils} child {node[ellipse,draw] fille}} child {node[diamond,draw] soeur}; </pre>
	<pre> \mode[rectangle,double,draw,text width=1cm,text centered] {père}[grow=right,level distance=2cm]  child {node[red,ultra thick,draw,rotate=45] {frère}} child {node[blue,dashed, draw] {moi}} child {node[ellipse,draw] {fils}} child {node [ellipse,fill] {filles}} child {node [magenta,pattern=dots,draw] {soeur}}; </pre>

### 28.6.1 Nom des noeuds

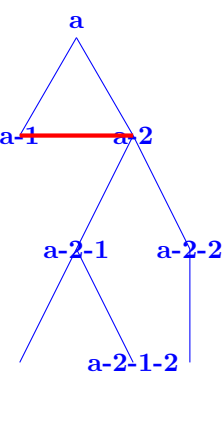
	<pre> \mode (a) {a} child child { child {child child} child {child } }; \mode at (a-1) {a-1}; \mode at (a-2) {a-2}; \mode at (a-2-2) {a-2-2}; \mode at (a-2-1) {a-2-1}; \mode at (a-2-1-2) {a-2-1-2};  \draw[red,ultra thick] (a-1) - (a-2); </pre>
---	---

<sup>1</sup>autres types de noeuds voir section 17

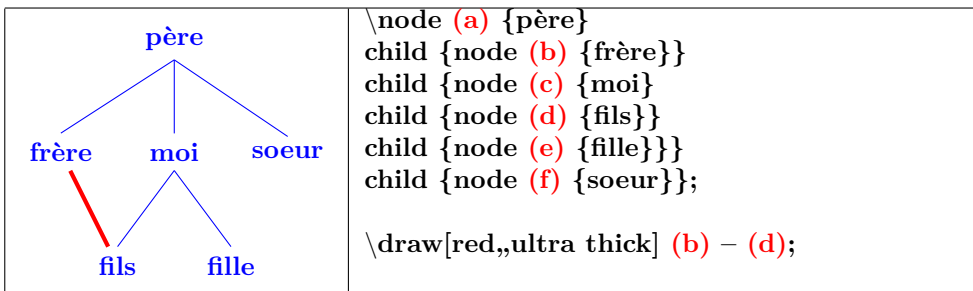
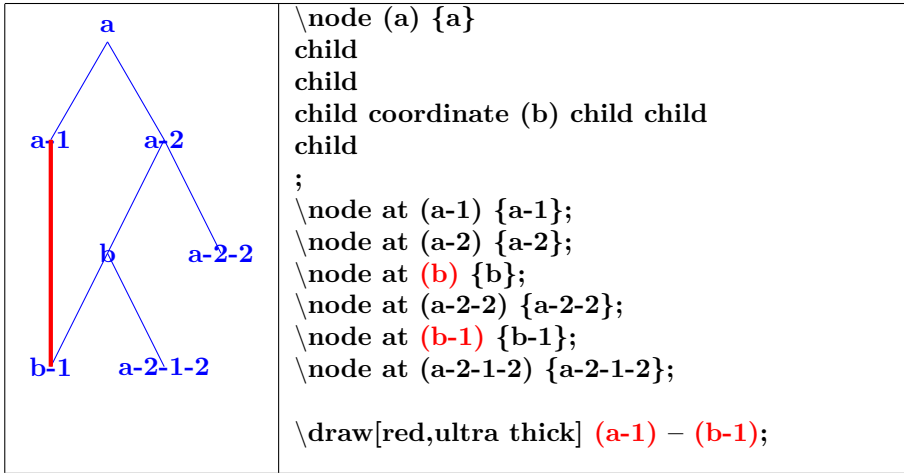

### 28.6.2 Omission d'un noeud

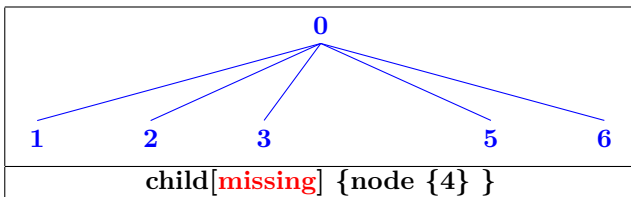

### 28.6.3 Modification du point d'accrochage

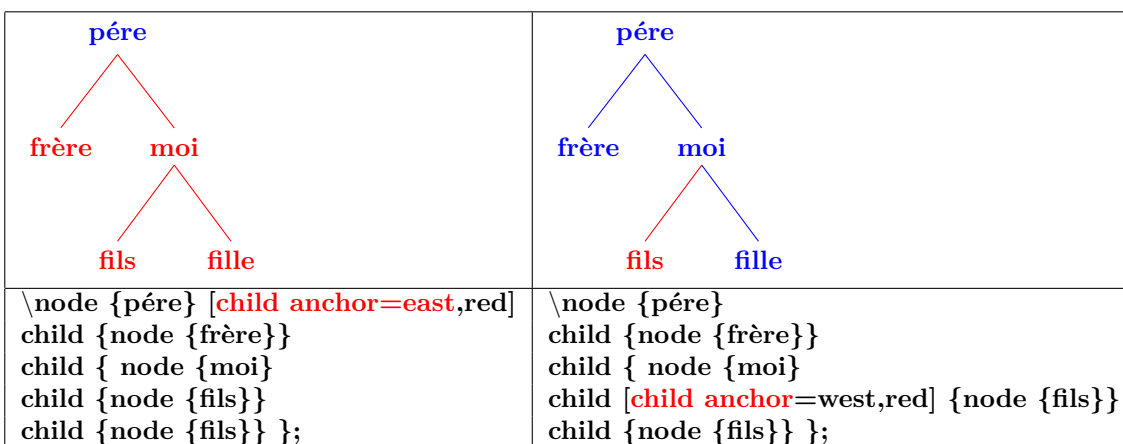

<pre>\node {père} [parent anchor=east,red] child {node {frère}} child { node {moi}} child {node {fils}} child {node {fille}}};</pre>	<pre>\node {père} child {node {frère}} child { node {moi}} child [parent anchor=west,red] {node {fils}} child {node {fille}}};</pre>

#### 28.6.4 Liaison

<pre>child {node {moi}} edge from parent[red,ultra thick]</pre>	<pre>child {node {fils}} edge from parent[red,ultra thick]</pre>	<pre>child { node {fille}} edge from parent[draw=none]</pre>

<pre>[edge from parent/.style={draw,red,ultra thick}] \node {père}</pre>

#### 28.6.5 Étiquettes sur liaisons

<pre>\node {père} child {node {fils} edge from parent node[left,red] {texte}};</pre>			
node[left,red]	node[right,red]	node[near end,red]	node[draw,red]



### 28.6.6 Personnalisation des liaisons

<code>[ edge from parent path= {(\tikzparentnode.south) .. controls +(0,-1) and +(0,1) .. (\tikzchildnode.north)} ]</code>		
<code>.. controls +(0,-1) and +(0,1) ..</code>	<code>- </code>	<code>to[in=90,out=-90]</code>
voir liaison de noeuds section 7.6		

## 28.7 Options supplémentaires avec « library trees »

Charger l'extension: `\usetikzlibrary{trees}`

PGFmanual section : 72

### 28.7.1 Positions d'un fils et de deux fils

`grow via three points={ one child at (0,1) and two children at (-.5,1) and (.5,1)}`

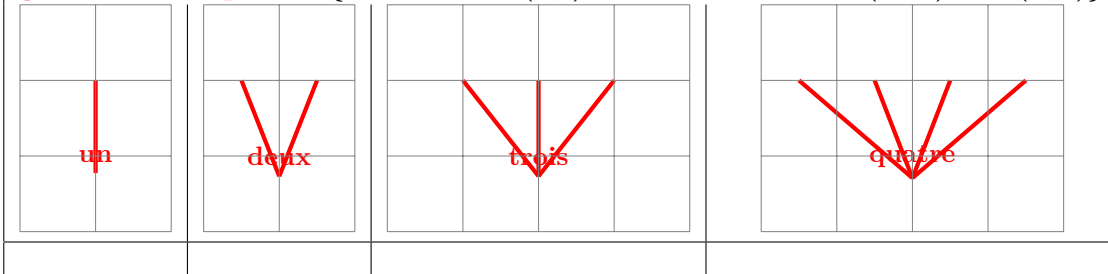

`grow via three points={ one child at (0,1) and two children at (0,1) and (1,1)}`



`grow via three points={ one child at (0,1) and two children at (-.5,1) and (.5,1.5)}`

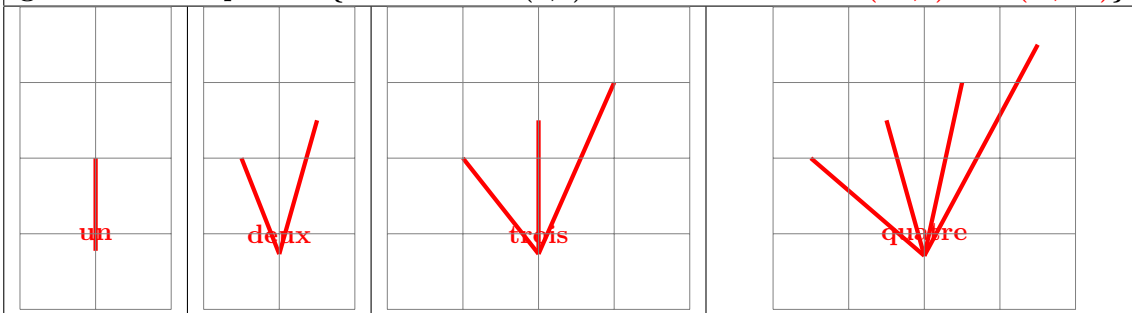

### 28.7.2 Liaison angulaire

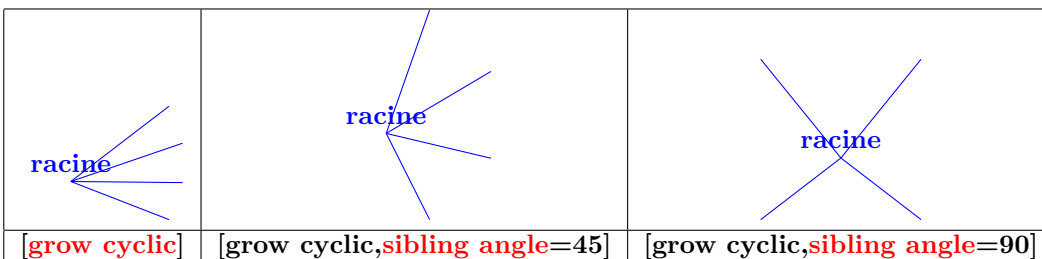

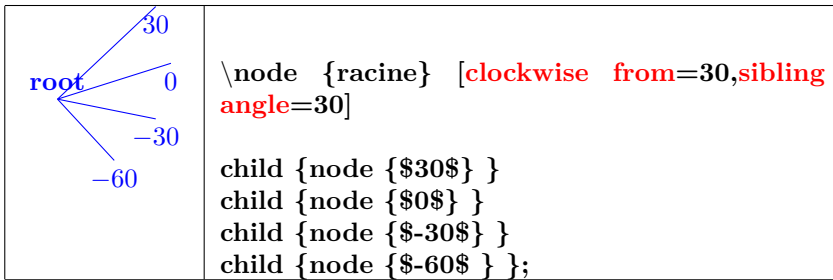

### 28.7.3 Liaisons en fourchette

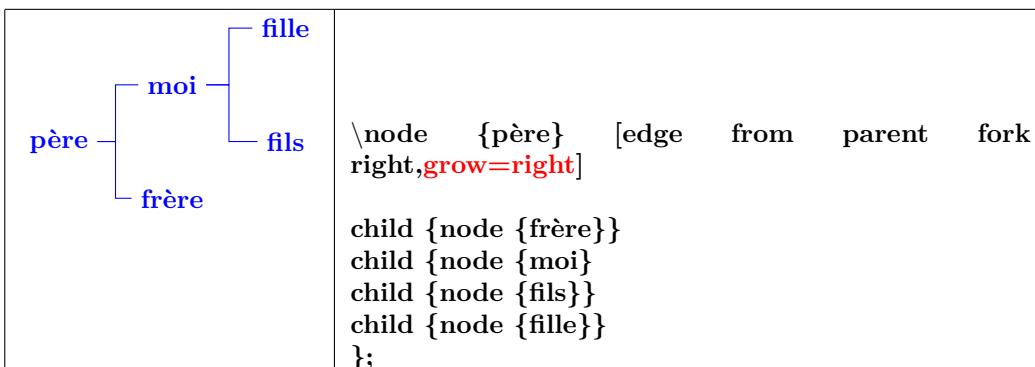
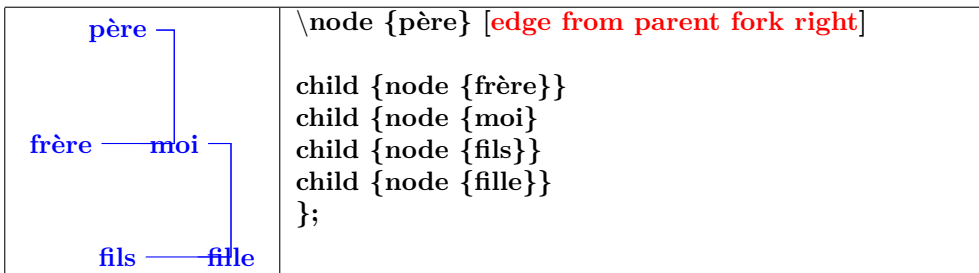
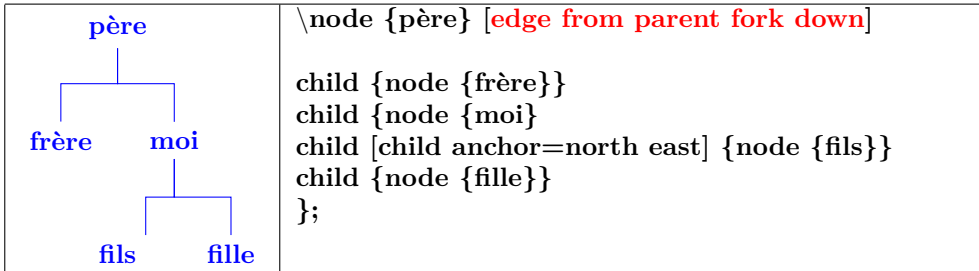









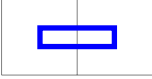
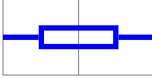

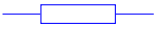





## 29 Les schemas électriques









Charger l'extension: `\usepackage{circuits.ee.IEC}`

### 29.1 Symboles

PGFmanual section : 47-4

sur un noeud	sur un chemin
	
<code>\node [circuit ee IEC] at (1,0.5) to [resistor] {} ;</code>	<code>\draw [circuit ee IEC](0,0.5) to [resistor] (2,.5) ;</code>

Composants de base			
<code>\draw [circuit ee IEC] (0,.5) to [resistor] (2,.5) ;</code>			
PGFmanual section : 47-4-3			
			
[resistor]	[inductor]	[capacitor]	[battery]
			
[bulb]	[current source]	[voltage source]	[ground]
PGFmanual section : 47-4-4			
			
[diode]	[Zener diode]	[Schottky diode]	[tunnel diode]
			
[backward diode]	[breakdown diode]		
PGFmanual section : 47-4-5			
			
[contact]	[make contact]	[break contact]	

Autre apparence		
<code>\draw [circuit ee IEC,set resistor graphic=var resistor IEC graphic] (0,0.5) to [resistor] (2,0.5) ;</code>		
		
resistor	inductor	diode
		
Zener diode	Schottky diode	tunnel diode
		
backward diode	breakdown diode	make contact

Taille des symboles				
PGFmanual section : 47-2-1				
\draw [circuit ee IEC] (0,0.5) to [diode,large circuit symbols] (2,0.5) ;				
huge circuit symbols (10pt)	large circuit symbols (8pt)	medium circuit symbols (7pt)	small circuit symbols (6pt)	tiny circuit symbols (5pt)

\draw [circuit ee IEC,circuit symbol unit=14pt] (0,0.5) to [diode] (2,0.5) ;		
circuit symbol unit=14pt	circuit symbol size=width 3 height 1	circuit symbol size=width 1 height 5 <small>ne fonctionne pas !</small>

Création de nouveaux symboles				
PGFmanual section : 47-2-2				
	<pre>\begin{tikzpicture} [circuit declare symbol=xxx, set xxx graphic={draw,shape=rectangle,minimum size=5mm}] \node [xxx] at (.5,.5) ; \draw[circuit ee IEC] (1,.5) to [xxx] (3,.5) ; \end{tikzpicture}</pre>			
shape=circle	shape=dart	shape=star	shape=forbidden sign	
voir les "different shape libraries"see the different shape libraries				

Placement des symboles sur un chemin	
\draw [circuit ee IEC] (0,0.5) to [contact={at start},make contact={very near start},voltage source={near end},resistor, bulb={near end}, bulb={very near end},contact={at end}] (12,0.5) ;	
\draw [circuit ee IEC] (0,0.5) to [contact={ pos=0 },make contact={pos=0.2},voltage source={pos=0.3},resistor={ pos=0.5 }, bulb={pos=0.75 },contact={pos =1 }] (12,0.5) ;	

Orientation des symboles			
PGFmanual section : 47-2-3			
\node [circuit ee IEC] at (1,.5) [diode,point up] {} ;			
[diode,point up]	[diode,point down]	[diode,point left]	[diode,point right]

Orientation automatique	
	<pre>\draw [circuit ee IEC] (0,0) to [voltage source] (1,1) to [resistor] (2,0) to [bulb] (1,-1) to [diode] (0,0) ;</pre>

## 29.2 Annotations

Sens du courant	
<a href="#">PGFmanual section : 47-4-2</a>	
<pre>\draw [circuit ee IEC] (0,0.5) to [current direction] (2,0.5) ;</pre>	
<pre>[current direction]</pre>	<pre>[current direction'</pre>

Unités disponibles				
<a href="#">PGFmanual section : 47-4-6</a>				
<pre>\node [draw,circuit ee IEC] at(1,.5) [ampere=5] {}</pre>				
5A <input type="checkbox"/>	5V <input type="checkbox"/>	5 <input type="checkbox"/>	5S <input type="checkbox"/>	5H <input type="checkbox"/>
[ampere=5]	[volt=5]	[ohm=5] <span style="background-color: #f0f0f0;">ne fonctionne pas !</span>	[siemens=5]	[henry=5]
5F <input type="checkbox"/>	5C <input type="checkbox"/>	5VA <input type="checkbox"/>	5W <input type="checkbox"/>	5Hz <input type="checkbox"/>
[farad=5]	[coulomb=5]	[voltampere=5]	[watt=5]	[hertz=5]
5kA <input type="checkbox"/>	5mA <input type="checkbox"/>	5 $\mu$ A <input type="checkbox"/>	5kW <input type="checkbox"/>	5MW <input type="checkbox"/>
[ampere=5k]	[ampere=5m]	[ampere=5\mu]	[watt=5k]	[watt=5M]

créer sa propre unité	
<a href="#">PGFmanual section : 47-2-4</a>	
<pre>\tikz[circuit ee IEC,circuit declare unit={xxx}]{ Unit} \draw (0,0) to[resistor={xxx' sloped=3}] (3,2) to [resistor={xxx= 10\mu}] (5,2) to [resistor={xxx= 10M}]</pre>	

Annotations			
PGFmanual section : 47-4-7			
\draw [circuit ee IEC] (0,0.5) to [resistor=light emitting] (2,0.5) ;			
[resistor=light emitting]	[resistor=light dependent]	[resistor=direction info]	[resistor=adjustable]
[diode=light emitting]	[diode=light dependent]	[diode=direction info]	[diode=adjustable]
[diode=light emitting']	[diode=light dependent']	[diode=direction info']	[diode=adjustable']

Position des unités	
PGFmanual section : 47-2-4	
\draw [circuit ee IEC] (0,0) to [capacitor={farad=5\mu}] (2,2) ;	
[capacitor={farad=5\mu}]	[capacitor={farad'=5\mu}]
[capacitor={farad sloped=5\mu}]	[capacitor={farad' sloped=5\mu}]

Informations		
PGFmanual section : 47-2-4		
\draw [circuit ee IEC] (0,0.5) to [diode={light emitting={info=D1}}] (2,0.5) ;		
[diode={light emitting={info=D1}}]	[diode={light emitting={info'=D2}}]	[diode={light emitting,info'=D3}]

sur un noeud	sur un chemin
[resistor,info=\$3\Omega\$,info'=R1]	[resistor={info=\$3\Omega\$,info'=R1}]

<code>[resistor,point up,info=center:\$3\Omega\$]</code>	<code>[resistor,point up,info=center:\$3\Omega\$]</code>

<code>\node [voltage source,direction info={volt=10}] {}</code>		<code>\node [voltage source,direction info'={volt=10}] {}</code>	
<code>{volt=10}</code> ou <code>{-&gt;,volt=10}</code>	<code>{volt'=10}</code> ou <code>{-&gt;,volt'=10}</code>	<code>{volt=10}</code> ou <code>{-&gt;,volt=10}</code>	<code>{volt'=10}</code> ou <code>{-&gt;,volt'=10}</code>
<code>{&lt;-,volt=10}</code>	<code>{&lt;-,volt=10}</code>	<code>{&lt;-,volt=10}</code>	<code>{&lt;-,volt'=10}</code>

Créer sa propre annotation <a href="#">PGFmanual section : 47-2-5</a>	
	<code>\tikzset{circuit declare annotation={XXX}{9pt}</code> <code>{ (-0.5cm,0.5cm) edge[to path={- -(0pt,2pt) - - (8pt,8pt)}] () }</code> <code>\tikz[blue,circuit ee IEC] \draw (0,0) to [resistor=XXX] (3,0);</code>
	<code>\tikzset{circuit declare annotation={xxx}{9pt}</code> <code>{ (-0.5cm,0.5cm) edge[to path={- -(0pt,2pt) - - (8pt,8pt)}] () }</code> <code>\tikz[blue,circuit ee IEC] \draw (0,0) to [resistor={xxx={info=abc}}] (3,0);</code>
	<code>\tikzset{circuit declare annotation={xxx}{1cm}</code> <code>{ (-0.5,0.5) edge[to path={- -(0pt,2pt) - - (8pt,8pt)}] () }</code> <code>\tikz[blue,circuit ee IEC] \draw (0,0) to [resistor={xxx={info=abc}}] (3,0);</code>



Style des symboles

[PGFmanual section : 47-2-6](#)

```
\draw[circuit symbol lines/.style={draw,red,very thick}] (0,0)
to [capacitor={near start},resistor, make contact={near end}] (5,0);
```

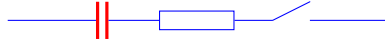

```
\draw[circuit symbol wires/.style={draw,red,very thick}] (0,0)
to [capacitor={near start},resistor, make contact={near end}] (5,0);
```

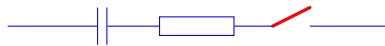

```
\draw[circuit symbol open/.style={thick,draw,red,fill=yellow}] (0,0)
to [capacitor={near start},resistor, make contact={near end}] (5,0);
```



```
\tikz[blue,circuit ee IEC, every info/.style=red]
\draw (0,0) to[resistor={info={3\Omega},info'={R_1}}] (3,0)
to[resistor={info={4\Omega},info'={R_2}}] (3,2);
```

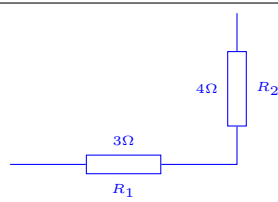
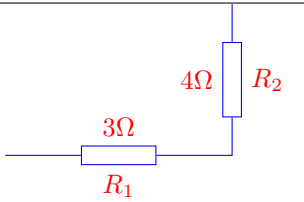

```
every info/.style=red
```

```
every info/.style={font=\tiny}
```

### 29.3 Exemple

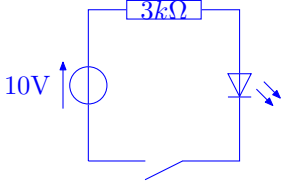
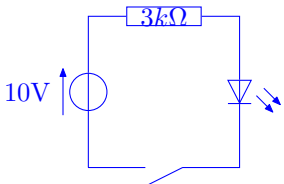
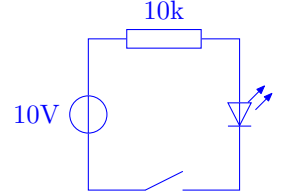
3 méthodes pour le même schéma	
	<pre>\begin{tikzpicture}[blue,circuit ee IEC] \draw (0,0) to [voltage source={direction info={-&gt;,volt=10}}] (0,2) to [resistor={info=center:\$3 k\Omega\$}] (2,2) to [diode=light emitting] ( 2,0) to [make contact] (0,0); \end{tikzpicture}</pre>
	<pre>\begin{tikzpicture}[blue,circuit ee IEC] \draw (0,0) to [voltage source={direction info={-&gt;,volt=10}}] ++(up:2) to [resistor={info=center:\$ 3 k\Omega\$}] ++(right:2) to [diode=light emitting] ++(down:2) to [make contact] ++(left:2) ; \end{tikzpicture}</pre>
	<pre>\begin{tikzpicture}[blue,circuit ee IEC] \node (A) at (0,1) [voltage source,point up,volt=10]{}; \node (B) at (1,2) [resistor,ohm=10k] {}; \node (C) at (2,1) [diode=light emitting,point down] {} ; \node (D) at ( 1,0) [make contact] {}; \draw (A)  - (B) -  (C)  - (D) -  (A); \end{tikzpicture}</pre>

## 30 Les circuits logiques

International Electrotechnical Commission :

























Charger l'extension: `\usepackage{circuits.logic.IEC}`



American logic gates :









Charger l'extension: `\usepackage{circuits.logic.US}`

logic symbols used in A. Croft, R. Davidson, and M. Hargreaves (1992), Engineering Mathematics, Addison-Wesley, 82–95 :

Charger l'extension: `\usepackage{circuits.logic.CDH}`



Composants de base		
<code>\node [circuit logic IEC] at (1,.5) [and gate ] {A} ;</code> <a href="#">PGFmanual section : 47-3-2</a>		
		
[circuit logic IEC] and gate	[circuit logic US] and gate	[circuit logic CDH] and gate
		
[circuit logic IEC] nand gate	[circuit logic US] nand gate	[circuit logic CDH] nand gate
		
[circuit logic IEC] or gate	[circuit logic US] or gate	[circuit logic CDH] or gate
		
[circuit logic IEC] nor gate	[circuit logic US] nor gate	[circuit logic CDH] nor gate
		
[circuit logic IEC] xor gate	[circuit logic US] xor gate	[circuit logic CDH] xor gate
		
[circuit logic IEC] xnor gate	[circuit logic US] xnor gate	[circuit logic CDH] xnor gate
		
[circuit logic IEC] not gate	[circuit logic US] not gate	[circuit logic CDH] not gate
		
[circuit logic IEC] buffer gate	[circuit logic US] buffer gate	[circuit logic CDH] buffer gate

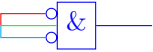
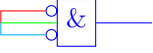

Avec etiquette		
<pre>\node [circuit logic IEC] at (1,.5) [and gate] {A} ;</pre> <p style="text-align: center;"><a href="#">PGFmanual section : 47-3-1</a></p>		
		
<code>[circuit logic IEC]</code>	<code>[circuit logic US]</code>	<code>[circuit logic CDH]</code>

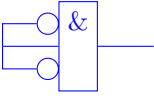
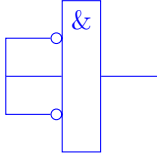
Orientation		
<pre>\node [circuit logic IEC] at (1,.5) [and gate,point down] {A} ;</pre> <p style="text-align: center;"><a href="#">PGFmanual section : 47-3-1</a></p>		
		
<code>[circuit logic IEC]</code>	<code>[circuit logic US]</code>	<code>[circuit logic CDH]</code>
<pre>\node [circuit logic IEC] at (1,.5) [and gate,point up] {A} ;</pre>		
		
<code>[circuit logic IEC]</code>	<code>[circuit logic US]</code>	<code>[circuit logic CDH]</code>
<pre>\node [circuit logic IEC] at (1,.5) [and gate,point left] {A} ;</pre>		
		
<code>[circuit logic IEC]</code>	<code>[circuit logic US]</code>	<code>[circuit logic CDH]</code>

Entrées sortie	
<p style="text-align: center;"><a href="#">PGFmanual section : 47-3-3</a></p>	
	<pre>\node [and gate IEC, draw, logic gate inputs={inverted ,normal , inverted }] at (1,.5) (A) {};</pre> <pre>\draw [red] (A.input 1) -  (0,0.5); \draw[green] (A.input 2) -  (0,0.5); \draw[cyan] (A.input 3) -  (0,0.5); \draw (A.output) -  (2,0.5);</pre>
	<pre>\node [and gate IEC, draw, logic gate inputs={ini}] at (1,.5) (A) {};</pre> <pre>\draw [red] (A.input 1) -  (0,0.5); \draw[green] (A.input 2) -  (0,0.5); \draw[cyan] (A.input 3) -  (0,0.5); \draw (A.output) -  (2,0.5);</pre>

Paramètres des entrées	
<code>\node [and gate IEC, draw, logic gate inputs=ini,logic gate inverted radius=4pt ] at (1,.5) (A) {};</code> <a href="#">PGFmanual section : 47-3-3</a>	
	
<code>logic gate inverted radius=4pt</code>	<code>logic gate input sep=0.5cm</code>

Paramètres des symboles		
<code>\node [circuit logic IEC,and gate IEC symbol=AND ] at (1,.5) [and gate] {}</code> <a href="#">PGFmanual section : 47-3-5</a>		
		
<code>and gate IEC symbol =AND</code>	<code>logic gate IEC symbol color =red</code>	<code>logic gate IEC symbol align ={bottom, right}</code>

Paramètres des composants		
<code>\node [circuit logic IEC,very thick ] at (1,.5) [and gate] {}</code> <a href="#">PGFmanual section : 47-3-5</a>		
		
<code>very thick</code>	<code>fill=blue!10</code>	<code>fill=blue!10, logic gate IEC symbol color=black</code>





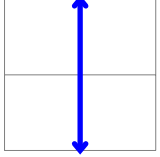









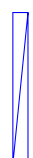

# 31 Optique

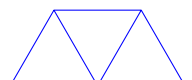
Charger l'extension: `\usepackage{optics} [8]`

	<pre>\begin{tikzpicture}[blue,line width=2pt] \draw[help lines] (-1,-1) grid (1,1); \node[use optics,lens] (L) at (0,0) ; \end{tikzpicture}</pre>
---	---



## 31.1 Éléments optiques

### 31.1.1 Éléments optiques disponibles

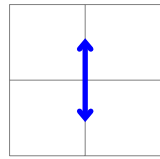
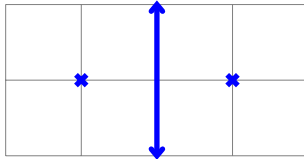
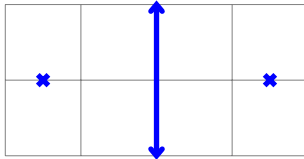
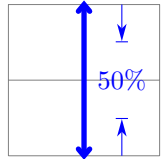

Éléments optiques				
<code>\tikz[use optics,blue] \node[lens] (L) at (0,0) {};</code>				
				
<b>lens</b>	<b>slit</b>	<b>double slit</b>	<b>mirror</b>	
				
<b>convex mirror</b>	<b>concave mirror</b>	<b>polarizer</b>	<b>beam splitter</b>	<b>double amici prism</b>
				
<b>thin optics element</b>	<b>thick optics element</b>	<b>heat filter</b>	<b>screen</b>	
				
<b>diffraction grating</b>	<b>grid</b>	<b>semi-transparent mirror</b>	<b>diaphragm</b>	

### 31.1.2 Paramètres

<code>\node[lens,object height=1cm] (L) at (0,0) {};</code>			
			
<b>object height=1cm</b> Par défaut : 2cm	<b>draw focal points</b> Par défaut : empty	<b>focal length=1.5cm</b> Par défaut : 1cm	<b>focal height=0.5</b> Par défaut : 0.8 (80%)

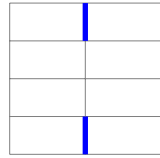
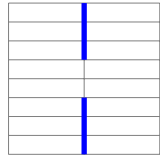
Lens type	
\node[lens,lens type=converging] (L) at (0,0) {};	
	
lens type=converging	lens type=diverging

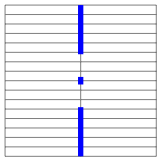
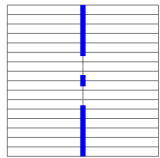
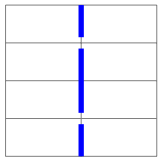
slit parameters	
\node[slit,slit height=0.5] (L) at (0,0) {};	
	
slit height=0.5	slit height=0.5cm
Par défaut : 0.075 (7.5%)	

Double slit parameters			
\node[double slit,slit height=0.15] (L) at (0,0) {};			
			
slit height=0.15	slit height=0.25cm	slit separation=0.5	double slit, slit separation=1cm
Par défaut : 0.075 (7.5% x 2cm = 1.5 mm)		Par défaut : 0.2 (20% x 2cm = 4mm)	

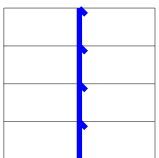
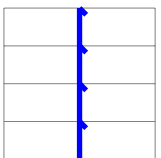
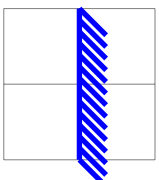
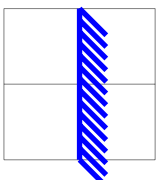
mirror parameters	
\node[mirror,mirror decoration separation=0.25] (L) at (0,0) {};	
	
mirror decoration separation=0.25	mirror decoration separation=0.5cm
Par défaut : 0.15cm	
	
mirror decoration amplitude=0.25	mirror decoration amplitude=1cm
Par défaut : 0.125cm	

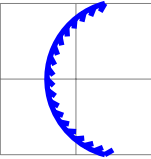
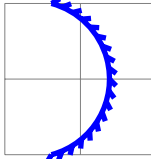
spherical mirror type	
\node[convex mirror](L) at (0,0) {};	
	
convex mirror	concave mirror
spherical mirror, spherical mirror type=convex	spherical mirror, spherical mirror type=concave

spherical mirror orientation	
<code>\node[convex mirror, spherical mirror orientation=ltr](L) at (0,0) {};</code>	
convex mirror, spherical mirror orientation=ltr	convex mirror, spherical mirror orientation=rtl
concave mirror spherical mirror orientation=ltr	concave mirror, spherical mirror orientation=rtl

<code>\node[spherical mirror, spherical mirror angle=240](L) at (0,0) {};</code>		
spherical mirror angle=240 Par défaut : 150	mirror decoration separation=0.25 Par défaut : 0.15cm	mirror decoration amplitude=0.5cm Par défaut : 0.125cm

<code>\node[spherical mirror, spherical mirror angle=from_radius(2cm)](L) at (0,0) {};</code>

<code>\node[polarizer, object height=1.5cm](L) at (0,0) {};</code>		
object height=1.5cm Par défaut : 2cm	object aspect ratio=0.5 Par défaut : 0.2	object aspect ratio=2

<code>\node[beam splitter, object height=1.5cm](L) at (0,0) {};</code>		
object height=1.5cm	object aspect ratio=.5	object aspect ratio=2



<code>\node[double amici prism,prism height=1cm](L) at (0,0) {};</code>	
<code>prism height=1cm</code> Par défaut : 1.5cm	<code>prism apex angle=90</code> Par défaut : 60







<code>\node[thick optics element,object height=1.5cm](L) at (0,0) {};</code>		
<code>object height=1.5cm</code>	<code>object aspect ratio=0.5</code>	<code>object aspect ratio=1.5</code>

### 31.1.3 Ancres

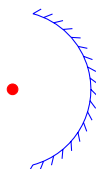
<code>\node[lens](L) at (0,0) {};</code> <code>\node[red,fill](L.lens north) circle (2pt) ;</code>				
<code>(L.lens north)</code>	<code>(L.lens south)</code>	<code>(L.east focus)</code>	<code>(L.west focus)</code>	<code>(L.center)</code>







<code>\node[slit, slit height=0.5](L) at (0,0) {};</code> <code>\node[red,fill](L.slit north) circle (2pt) ;</code>		
<code>(L.slit north)</code>	<code>(L.slit south)</code>	<code>(L.slit center)</code>

<code>\node[double slit,slit height=0.2,slit separation=0.5](L) at (0,0) {};</code> <code>\node[red,fill](L.slit 1 north) circle (2pt) ;</code>					
<code>(L.slit 1 north)</code>	<code>(L.slit 1 south)</code>	<code>(L.slit 1 center)</code>	<code>(L.slit 2 north)</code>	<code>(L.slit 2 south)</code>	<code>(L.slit 2 center)</code>

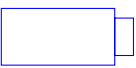
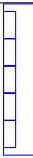
$\backslash$ node[spherical mirror] (L) at (0,0) {}; $\backslash$ node[red,fill] (L.mirror center) circle (2pt) ;						
						
L.mirror center	L.focus	L.arc start	L.arc center	L.arc end	L.45	L.-45

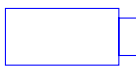
### 31.2 Lampes et capteurs

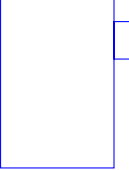
#### 31.2.1 Disponibles

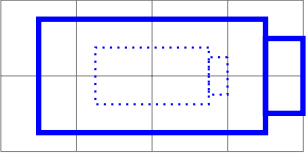
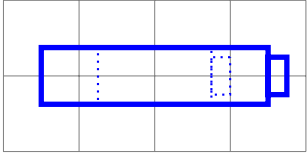
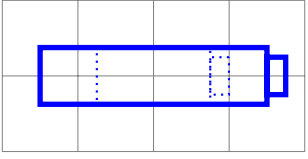
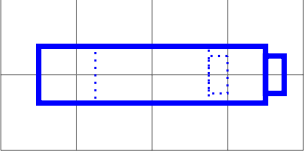
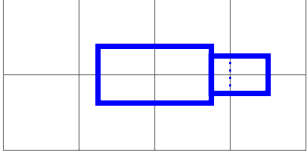
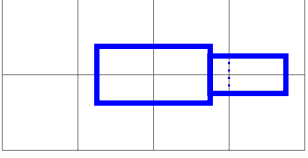
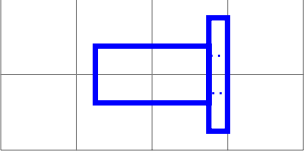
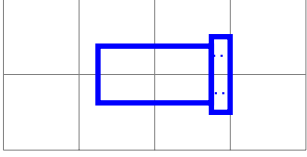
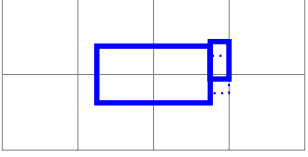
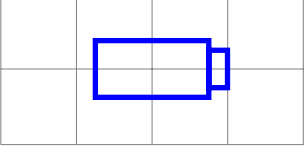
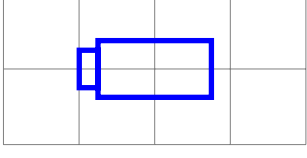

$\backslash$ tikz[use optics,scale=.5,blue] $\backslash$ node[generic optics io] (L) at (0,0) {};			
			
generic optics io	sensor line	generic sensor	generic lamp
			
halogen lamp	spectral lamp	laser ;	laser'

### 31.2.2 Paramètres

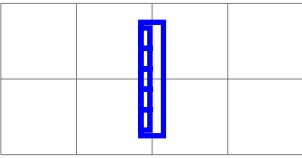
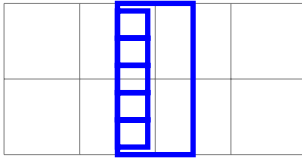
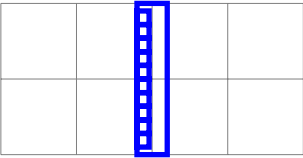
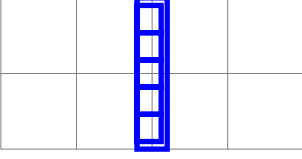
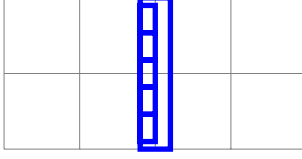
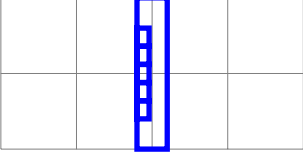
\node[ <b>generic optics io</b> , <b>io body height=1.5cm</b> ](L) at (0,0) {};		
Paramètres applicables pour <b>generic sensor</b> , <b>generic lamp</b> , <b>halogen lamp</b> , <b>spectral lamp</b> , <b>laser</b>		
		
<b>io body height=1.5cm</b> Par défaut : 0.75cm	<b>io body aspect ratio=4</b> Par défaut : 2	<b>io body width=4</b>
		
<b>io body width=3cm</b>	<b>io aperture width=1</b>	<b>io aperture width=1cm</b> Par défaut : 0.33
		
<b>io aperture height=2</b> Par défaut : 0.66	<b>io aperture height=1cm</b>	<b>io aperture shift=0.25</b> Par défaut : 0
		
<b>io orientation=ltr</b>	<b>io orientation=rtl</b> Par défaut : ltr	

\node[ <b>sensor line</b> , <b>sensor line height=1.5cm</b> ](L) at (0,0) {};		
		
<b>sensor line height=1.5cm</b> Par défaut : 2cm	<b>sensor line aspect ratio=0.5</b> Par défaut : 0.2	<b>sensor line pixel number=10</b> Par défaut : 5
		
<b>sensor line pixel width=0.8</b> Par défaut : 0.4	<b>sensor line pixel width=0.2cm</b>	<b>sensor line inner ysep=0.2</b> Par défaut : 0.05

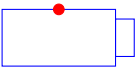
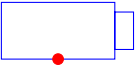
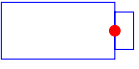
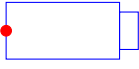
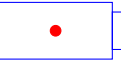

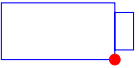
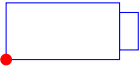
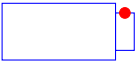
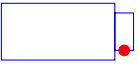
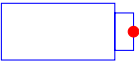
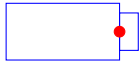
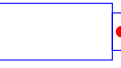
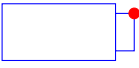
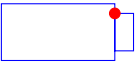
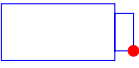
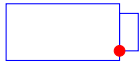
### 31.2.3 Points d'ancrages

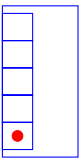
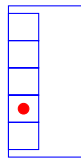
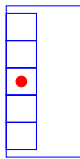
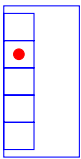
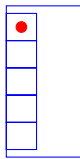
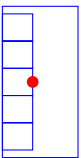
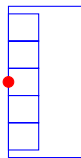
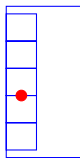
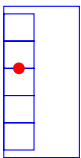
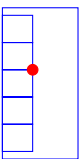
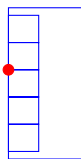
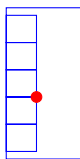
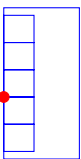

				
s.body north	s.body south	s.body east	s.body west	s.body cent
				
s.body north east	s.body north west	s.body south east	s.body south west	
				
s.aperture north	s.aperture south	s.aperture east	s.aperture west	s.aperture cen
				
s.aperture north east	s.aperture north west	s.aperture south east	s.aperture south west	

				
s.pixel 1 center	s.pixel 2 center	s.pixel 3 center	s.pixel 4 center	s.pixel 5 center
				
s.pixel 3 east	s.pixel 3 west	s.pixel 3 south	s.pixel 3 north	
				
s.pixel 3 north east	s.pixel 3 north west	s.pixel 3 south east	s.pixel 3 south west	

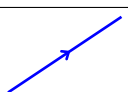
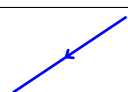
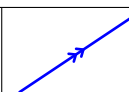
### 31.3 Outils

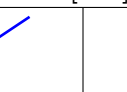
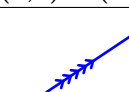
#### 31.3.1 Marquer des rayons

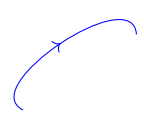
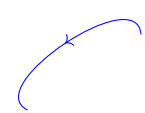
<code>\draw [-&gt;-] (0,0) - (1.5,1);</code>					
					
<code>[-&gt;-]</code>	<code>[-&lt;-]</code>	<code>[-&gt; &gt;-]</code>	<code>[-&gt;n={n=4}]</code>	<code>[-&gt;n={n=5,at=0.25}]</code>	<code>[-&gt; &gt;-at=0.25, -&gt;-at=0.75]</code>

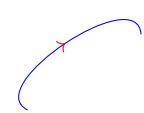
<code>\draw [put arrow] (0,0) to[bend left=120] (2,0);</code>			
			
<code>[put arrow]</code>	<code>[put arrow={arrow'}]</code>	<code>[put arrow={at=0.2}]</code>	<code>[put arrow={style=red}]</code>

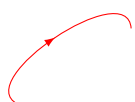
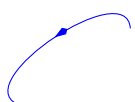
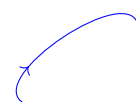
		
<code>[red,put arrow={arrow=latex}]</code>	<code>[put arrow={arrow'=Kite}]</code>	<code>[put arrow={pos=.25}]</code>
Par défaut : <code>pos=0.5</code>		

```
\draw[red, put arrow/ every arrow/.style={blue}, put arrow={at=0.2},
put arrow={at=0.5}, put arrow={at=0.8}] (0,0) - (5,0);
```

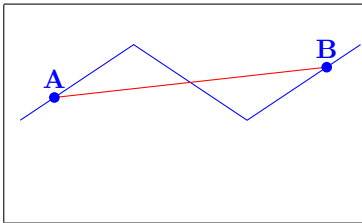
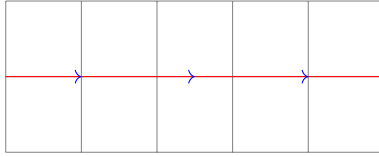

```
\begin{tikzpicture}[use optics,blue]
\draw[put coordinate=A at 0.1,put coordinate=B at 0.9]
(0,0) - - (1.5,1) - - (3, 0) - - (4.5,1);
\draw[red] (A) - - (B);
\fill(A) circle (2pt) node[above] {A} ;
\fill(B) circle (2pt) node[above] {B} ;
\end{tikzpicture}
```

Point A à 10% , point B à 90%

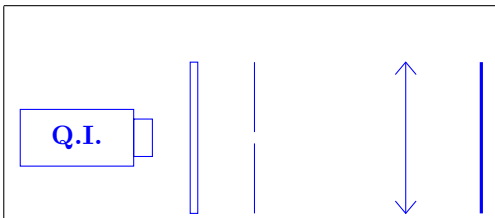

```
\begin{tikzpicture}[use optics]
\node[halogen lamp] (quartz iode) at (0,0) {Q.I.};
\node[heat filter,right=0.5cm of quartz iode.aperture east]
(AC) {};
\node[slit,right=0.75cm of AC] (fente) {};
\node[lens,right=2cm of fente] (L) {};
\node[screen,right=3cm of fente] (screen) {};
\end{tikzpicture}
```

### 31.3.2 Cotation

```
\draw (0,0) to[short dim arrow={label=2cm}] (2,0);
```

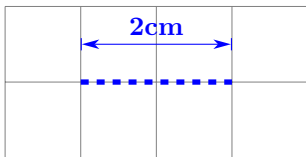

[dim arrow={label=2cm}]

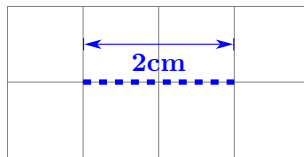

to[dim arrow={label'=2cm}]

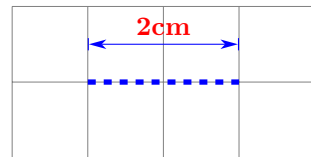

[dim arrow={label=2cm  
label style/.append style=r}

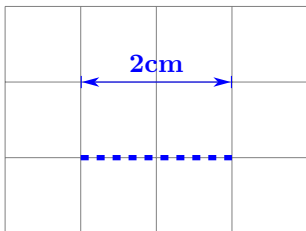

[dim arrow={label=2cm,raise=1cm}]

Par défaut : raise = 0.5cm

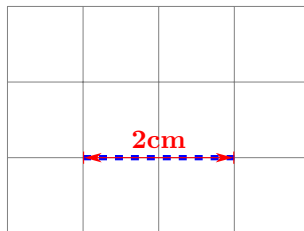

[dim arrow={label=2cm,no raise},red]

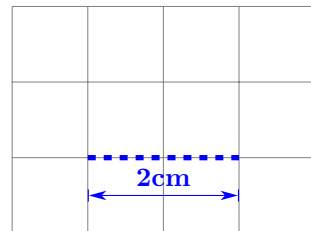

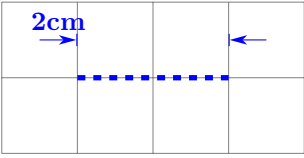
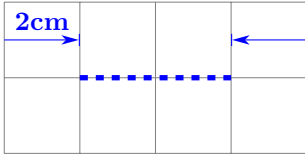
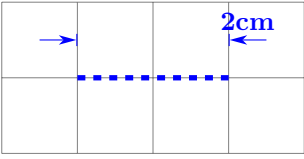
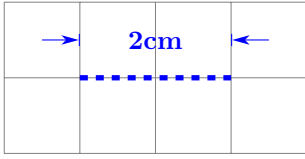

[dim arrow'={label=2cm}

<code>\draw (0,0) to[short dim arrow={label=2cm}] (2,0);</code>	
	
<code>[short dim arrow={label=2cm}]</code>	<code>[short dim arrow={label=2cm,arrow length=1cm}]</code> Par défaut : arrow length= 5mm
	
<code>[short dim arrow={label=2cm,label near end}]</code>	<code>[short dim arrow={label=2cm,label near middle}]</code> Par défaut : label near start

## 32 Les animations

Charger l'extension: `\usepackage{animate}` [7]

### 32.1 Animation à partir de fichiers d'image

première image	seconde et dernière image
	
<code>\includegraphics{XXX1}</code>	<code>\includegraphics{XXX2}</code>

<code>\animategraphics:</code>	
<code>[ controls,</code>	<code>:boutons de contrôle</code>
<code>loop</code>	<code>:en boucle</code>
<code>autoplay ]</code>	<code>:auto démarrage</code>
<code>{4}</code>	<code>:4 fois par seconde</code>
<code>{XXX}</code>	<code>:base du nom fichier</code>
<code>{1}</code>	<code>:numero de début</code>
<code>{2}</code>	<code>:numero de fin</code>

### 32.2 Animateinline

```

\begin{animateinline}[controls,loop,autoplay]{5}

% première image
\begin{tikzpicture} \fill[blue] (45:2) -- (135:.5) -- (225:2) -- (315:.5)
-- cycle; \fill[blue] (45:.5) -- (135:2) -- (225:.5) -- (315:2) -- cycle;
\end{tikzpicture}
% deuxième
\newframe
\begin{tikzpicture}
\fill[blue] (0:2) -- (90:.5) -- (180:2) -- (270:.5) -- cycle;
\fill[blue] (0:.5) -- (90:2) -- (180:.5) -- (270:2) -- cycle;
\end{tikzpicture}

\end{animateinline}

```



### 32.3 Multiframe

```

\begin{animateinline}[poster=first,controls, palindrome]{12}
\multiframe{29}{iAngle=80+10, Rdim=2.0+-0.2}{
\begin{tikzpicture}
\fill[blue] (\iAngle+45:\Rdim) - - (\iAngle+135:.5) - -
(\iAngle+225:\Rdim) - - (\iAngle+315:.5) - - cycle;
\fill[blue] (\iAngle+45:.5) - - (\iAngle+135:\Rdim) - - (\iAn-
gle+225:.5) - - (\iAngle+315:\Rdim) - - cycle;
\end{tikzpicture} }
\end{animateinline}

```

L'initiale de la variable définit son type

entier	initiale : i ou I
réelles	initiale : n, N, r ou R
longueurs	initiale : d ou D







```

\begin{animateinline}[autoplay,loop]{12}
\multiframe{24}{iAngle=0+15,icol=0+5}{\begin{tikzpicture}
\draw[line width=0pt] (-2,-3) rectangle(6,3);
\draw (0,0) node[fill=white,circle,rotate=\iAngle]
{\includegraphics[width=2cm]{LogoIUT}} (0,0) circle (1);
\draw (0,0) circle (1);
\coordinate (abc) at ($\sqrt{9-\sin(\iAngle)*\sin(\iAngle))+\cos(\iAngle)}*(1,0)$
;
\coordinate (xyz) at (\iAngle:1);
\draw[ultra thick] (0,0) - -(xyz);
\draw[ultra thick] (xyz) - - (abc) ;
\fill[color=blue!\icol] (abc)++(0.5,-1) rectangle (5,1) ;
\draw[ultra thick] (abc) ++(0,-1) rectangle ++(.5,2) ;
\draw[ultra thick] (1.5,1) - - (5,1) - - (5,-1) - - (1.5,-1);
\fill[red] (xyz) circle (4pt);
\fill[red] (abc) circle (4pt);
\end{tikzpicture}}
\end{animateinline}

```

### 33 Les modules étudiés dans ce document

module de base TikZ :		
nom	A insérer dans le préambule	documentation <sup>1</sup>
tikz	<code>\usepackage{tikz}</code>	pgfmanual.pdf 

Autres modules			
nom	voir page	documentation <sup>2</sup>	
animate	215	animate.pdf	
tikz-optics	205	tikz-optics.pdf	
pgfplots	165	pgfplots.pdf	
tikzpeople	142	tikzpeople.pdf	
tikzducks	149	tikzducks-doc.pdf	
tikzsymbols	155	tikzsymbols.pdf	
tkz-tab	176	tkz-tab-screen.pdf	

Compléments optionnels (documentation : pgfmanual.pdf)		
nom	voir page	A insérer dans le préambule
angles	37	<code>\usetikzlibrary{angles}</code>
arrows.meta	21	<code>\usetikzlibrary{arrows.meta}</code>
bending	34	<code>\usetikzlibrary{bending}</code>
backgrounds	79	<code>\usetikzlibrary{backgrounds}</code>
calc	45	<code>\usetikzlibrary{calc}</code>
chains	67	<code>\usetikzlibrary{chains}</code>
circuits.ee.IEC	195	<code>\usetikzlibrary{circuits.ee.IEC}</code>
circuits.logic.IEC	201	<code>\usetikzlibrary{circuits.logic.IEC}</code>
circuits.logic.US	201	<code>\usetikzlibrary{circuits.logic.US}</code>
circuits.logic.CDH	201	<code>\usetikzlibrary{circuits.logic.CDH}</code>
fit	58	<code>\usetikzlibrary{fit}</code>
decorations.footprints	129	<code>\usetikzlibrary{decorations.footprints}</code>
decorations.fractals	136	<code>\usetikzlibrary{decorations.fractals}</code>
decorations.markings	126	<code>\usetikzlibrary{decorations.markings}</code>
decorations.pathmorphing	114	<code>\usetikzlibrary{decorations.pathmorphing}</code>
decorations.pathreplacing	121	<code>\usetikzlibrary{decorations.pathreplacing}</code>
decorations.shapes	130	<code>\usetikzlibrary{decorations.shapes}</code>
decorations.text	134	<code>\usetikzlibrary{decorations.text}</code>
fadings	84	<code>\usetikzlibrary{fadings}</code>
intersections	43	<code>\usetikzlibrary{intersections}</code>
matrix	64	<code>\usetikzlibrary{matrix}</code>
patterns	17	<code>\usetikzlibrary{patterns}</code>
plotmarks	164	<code>\usetikzlibrary{plotmarks}</code>
positioning	56	<code>\usetikzlibrary{positioning}</code>
scopes	76	<code>\usetikzlibrary{scopes}</code>
shadings	20	<code>\usetikzlibrary{shadings}</code>
shapes.arrows	96	<code>\usetikzlibrary{shapes.arrows}</code>
shapes.callouts	98	<code>\usetikzlibrary{shapes.callouts}</code>
shapes.geometric	91	<code>\usetikzlibrary{shapes.geometric}</code>
shapes.misc	100	<code>\usetikzlibrary{shapes.misc}</code>
shapes.multipart	102	<code>\usetikzlibrary{shapes.multipart}</code>
shapes.symbols	94	<code>\usetikzlibrary{shapes.symbols}</code>
through	60	<code>\usetikzlibrary{through}</code>
trees	193	<code>\usetikzlibrary{trees}</code>
through	184	<code>\usetikzlibrary{turtle}</code>







<sup>1</sup>voir dans le répertoire : `\texlive\2016\tesmf-dist\doc\generic\pgf`

<sup>2</sup>chercher dans le répertoire : `\texlive\2016\tesmf-dist\doc\latex`

dans une prochaine mise à jour

automata	<a href="#">PGFmanual section : 41</a>
babel	<a href="#">PGFmanual section : 42</a>
calendar	<a href="#">PGFmanual section : 45</a>
circular graph drawing library	<a href="#">PGFmanual section : 32</a>
curvilinear library	<a href="#">PGFmanual section : 103-4-7</a>
datavisualization library	<a href="#">PGFmanual section : 75</a>
datavisualization.formats.functions library	<a href="#">PGFmanual section : 76-4</a>
datavisualization.polar library	<a href="#">PGFmanual section : 80</a>
er	<a href="#">PGFmanual section : 49</a>
examples graph drawing library	<a href="#">PGFmanual section : 35-8</a>
external	<a href="#">PGFmanual section : 50</a>
fixedpointarithmetic	<a href="#">PGFmanual section : 53</a>
folding	<a href="#">PGFmanual section : 59</a>
force graph drawing library	<a href="#">PGFmanual section : 31</a>
fpv	<a href="#">PGFmanual section : 54</a>
graph.standard library	<a href="#">PGFmanual section : 19-10</a>
graphdrawing library	<a href="#">PGFmanual section : 27</a>
graphs library	<a href="#">PGFmanual section : 19</a>
layered graph drawing library	<a href="#">PGFmanual section : 30</a>
lindenmeyersystems	<a href="#">PGFmanual section : 55</a>
mindmap	<a href="#">PGFmanual section : 58</a>
petri	<a href="#">PGFmanual section : 61</a>
phylogenetics graph drawing library	<a href="#">PGFmanual section : 33</a>
plotters	<a href="#">PGFmanual section : 62</a>
profiler	<a href="#">PGFmanual section : 64</a>
quotes library	<a href="#">PGFmanual section : 17-10-4</a>
routing graph drawing library	<a href="#">PGFmanual section : 34</a>
shadows	<a href="#">PGFmanual section : 66</a>
spy	<a href="#">PGFmanual section : 68</a>
svg.path	<a href="#">PGFmanual section : 69</a>
topaths	<a href="#">PGFmanual section : 70</a>
trees graph drawing library	

## References

- [1] pgfmanual.pdf      version 3.0.1a      1161 pages      
- [2] pgfplots.pdf      version 1.80      439 pages      
- [3] tkz-tab-screen.pdf      version 1.1c      83 pages      
- [4] tikzpeople.pdf      19 pages      
- [5] tikzducks-doc.pdf      version 0.6      28 pages      
- [6] tikzsymbols.pdf      version sept 2017      15 pages      
- [7] animate.pdf      26 pages      
- [8] tikz-optics.pdf      version 0.2.2      39 pages      